

Wespack Phase Control Thyristor

Types N3229QK020 to N3229QK060

Development Type No.: NX155QK020-060

Absolute Maximum Ratings

	VOLTAGE RATINGS	MAXIMUM LIMITS	UNITS
V_{DRM}	Repetitive peak off-state voltage, (note 1)	200-600	V
V_{DSM}	Non-repetitive peak off-state voltage, (note 1)	200-600	V
V_{RRM}	Repetitive peak reverse voltage, (note 1)	200-600	V
V_{RSM}	Non-repetitive peak reverse voltage, (note 1)	300-700	V

	OTHER RATINGS	MAXIMUM LIMITS	UNITS	
$I_{T(AV)M}$	Maximum average on-state current, $T_{sink}=55^{\circ}C$, (note 2)	3229	A	
$I_{T(AV)M}$	Maximum average on-state current. $T_{sink}=85^{\circ}C$, (note 2)	2327	A	
$I_{T(AV)M}$	Maximum average on-state current. $T_{sink}=85^{\circ}C$, (note 3)	1122	A	
$I_{T(RMS)M}$	Nominal RMS on-state current, $T_{sink}=25^{\circ}C$, (note 2)	6305	A	
$I_{T(d.c.)}$	D.C. on-state current, $T_{sink}=25^{\circ}C$, (note 4)	5052	A	
I_{TSM}	Peak non-repetitive surge $t_p=10ms$, $V_{rm}=60\%V_{RRM}$, (note 5)	28.0	kA	
I_{TSM2}	Peak non-repetitive surge $t_p=10ms$, $V_{rm}\leq 10V$, (note 5)	30.8	kA	
I^2t	I^2t capacity for fusing $t_p=10ms$, $V_{rm}=60\%V_{RRM}$, (note 5)	3.92×10^6	A^2s	
I^2t	I^2t capacity for fusing $t_p=10ms$, $V_{rm}\leq 10V$, (note 5)	4.74×10^6	A^2s	
$(di/dt)_{cr}$	Critical rate of rise of on-state current (note 6)	(continuous, 50Hz)	100	A/ μs
		(repetitive, 50Hz, 60s)	200	
		(non-repetitive)	400	
V_{RGM}	Peak reverse gate voltage	5	V	
$P_{G(AV)}$	Mean forward gate power	4	W	
P_{GM}	Peak forward gate power	30	W	
$T_{j op}$	Operating temperature range	-40 to +140	$^{\circ}C$	
T_{stg}	Storage temperature range	-40 to +150	$^{\circ}C$	

Notes:-

- 1) De-rating factor of 0.13% per $^{\circ}C$ is applicable for T_j below $25^{\circ}C$.
- 2) Double side cooled, single phase; 50Hz, 180° half-sinewave.
- 3) Cathode side cooled, single phase; 50Hz, 180° half-sinewave.
- 4) Double side cooled.
- 5) Half-sinewave, $140^{\circ}C$ T_j initial.
- 6) $V_D=67\% V_{DRM}$, $I_{TM}=2000A$, $I_{FG}=2A$, $t_r\leq 0.5\mu s$, $T_{case}=140^{\circ}C$.

Characteristics

	PARAMETER	MIN.	TYP.	MAX.	TEST CONDITIONS (Note 1)	UNITS
V _{TM}	Maximum peak on-state voltage	-	-	1.20	I _{TM} =4000A	V
V _{TM}	Maximum peak on-state voltage	-	-	1.57	I _{TM} =9700A	V
V _{T0}	Threshold voltage	-	-	0.926		V
r _T	Slope resistance	-	-	0.067		mΩ
(dv/dt) _{cr}	Critical rate of rise of off-state voltage	1000	-	-	V _D =80% V _{DRM} , linear ramp, gate o/c	V/μs
I _{DRM}	Peak off-state current	-	-	100	Rated V _{DRM}	mA
I _{RRM}	Peak reverse current	-	-	100	Rated V _{RRM}	mA
V _{GT}	Gate trigger voltage	-	-	3.0	T _j =25°C V _D =10V, I _T =3A	V
I _{GT}	Gate trigger current	-	-	300		mA
V _{GD}	Gate non-trigger voltage	-	-	0.25		Rated V _{DRM}
I _H	Holding current	-	-	1000	T _j =25°C	mA
t _{gd}	Gate-controlled turn-on delay time	-	0.5	1.5	V _D =67% V _{DRM} , I _T =1000A, di/dt=10A/μs, I _{FG} =2A, t _r =0.5μs, T _j =25°C	μs
t _{gt}	Turn-on time	-	1.0	2.0		μs
Q _{rr}	Recovered charge	-	850	-	I _{TM} =1000A, t _p =1000μs, di/dt=10A/μs, V _r =50V	μC
Q _{ra}	Recovered charge, 50% Chord	-	450	600		μC
I _{rm}	Reverse recovery current	-	75	-		A
t _{rr}	Reverse recovery time, 50% Chord	-	12	-		μs
t _q	Turn-off time	-	150	-	I _{TM} =1000A, t _p =1000μs, di/dt=10A/μs, V _r =50V, V _{dr} =80%V _{DRM} , dV _{dr} /dt=20V/μs	μs
		-	200	-	I _{TM} =1000A, t _p =1000μs, di/dt=10A/μs, V _r =50V, V _{dr} =80%V _{DRM} , dV _{dr} /dt=200V/μs	
R _{thJK}	Thermal resistance, junction to heatsink	-	-	0.0180	Double side cooled	K/W
		-	-	0.0303	Anode side cooled	K/W
		-	-	0.0444	Cathode side cooled	K/W
F	Mounting force	16	-	20	Note 2.	kN
W _t	Weight	-	200	-		g

Notes:-

- 1) Unless otherwise indicated T_j=140°C.
- 2) For other clamp forces, please consult factory.

Notes on Ratings and Characteristics

1.0 Voltage Grade Table

Voltage Grade	V_{DRM} V_{DSM} V_{RRM} V	V_{RSM} V	V_D V_R DC V
02	200	300	140
04	400	500	260
06	600	700	420

2.0 Extension of Voltage Grades

This report is applicable to other voltage grades when supply has been agreed by Sales/Production.

3.0 De-rating Factor

A blocking voltage de-rating factor of 0.13%/°C is applicable to this device for T_j below 25°C.

4.0 Repetitive dv/dt

Standard dv/dt is 1000V/μs.

5.0 Snubber Components

When selecting snubber components, care must be taken not to use excessively large values of snubber capacitor or excessively small values of snubber resistor. Such excessive component values may lead to device damage due to the large resultant values of snubber discharge current. If required, please consult the factory for assistance.

6.0 Rate of rise of on-state current

The maximum un-primed rate of rise of on-state current must not exceed 400A/μs at any time during turn-on on a non-repetitive basis. For repetitive performance, the on-state rate of rise of current must not exceed 200A/μs at any time during turn-on. Note that these values of rate of rise of current apply to the total device current including that from any local snubber network.

7.0 Gate Drive

The nominal requirement for a typical gate drive is illustrated below. An open circuit voltage of at least 30V is assumed. This gate drive must be applied when using the full di/dt capability of the device.

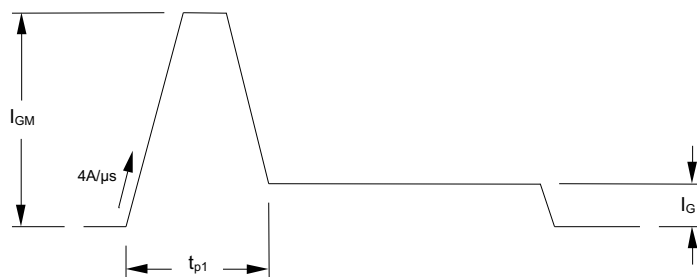

The magnitude of I_{GM} should be between five and ten times I_{GT} , which is shown on page 2. Its duration (t_{p1}) should be 20μs or sufficient to allow the anode current to reach ten times I_L , whichever is greater. Otherwise, an increase in pulse current could be needed to supply the necessary charge to trigger. The 'back-porch' current I_G should remain flowing for the same duration as the anode current and have a magnitude in the order of 1.5 times I_{GT} .

8.0 Computer Modelling Parameters

8.1 Device Dissipation Calculations

$$I_{AV} = \frac{-V_{T0} + \sqrt{V_{T0}^2 + 4 \cdot ff^2 \cdot r_T \cdot W_{AV}}}{2 \cdot ff^2 \cdot r_T}$$

and:

$$W_{AV} = \frac{\Delta T}{R_{th}}$$

$$\Delta T = T_{j\max} - T_K$$

Where $V_{T0}=0.926V$, $r_T=0.067m\Omega$,

R_{th} = Supplementary thermal impedance, see table below and

ff = Form factor, see table below.

Supplementary Thermal Impedance							
Conduction Angle	30°	60°	90°	120°	180°	270°	d.c.
Square wave Double Side Cooled	0.0269	0.0246	0.0237	0.0217	0.0202	0.0188	0.0180
Square wave Cathode Side Cooled	0.0531	0.0501	0.0485	0.0475	0.0463	0.0452	0.0444
Sine wave Double Side Cooled	0.0245	0.0221	0.0208	0.0189	0.0180		
Sine wave Cathode Side Cooled	0.0497	0.0470	0.0460	0.0455	0.0444		

Form Factors							
Conduction Angle	30°	60°	90°	120°	180°	270°	d.c.
Square wave	3.46	2.45	2	1.73	1.41	1.15	1
Sine wave	3.98	2.78	2.22	1.88	1.57		

8.2 Calculating V_T using ABCD Coefficients

The on-state characteristic I_T vs. V_T , on page 6 is represented in two ways;

- (i) the well established V_{T0} and r_T tangent used for rating purposes and
- (ii) a set of constants A, B, C, D, forming the coefficients of the representative equation for V_T in terms of I_T given below:

$$V_T = A + B \cdot \ln(I_T) + C \cdot I_T + D \cdot \sqrt{I_T}$$

The constants, derived by curve fitting software, are given below for both hot and cold characteristics. The resulting values for V_T agree with the true device characteristic over a current range, which is limited to that plotted.

25°C Coefficients		140°C Coefficients	
A	0.88664645	A	0.49618625
B	-1.647773×10^{-3}	B	0.04500253
C	1.94247×10^{-5}	C	4.26433×10^{-5}
D	5.584392×10^{-3}	D	2.529625×10^{-3}

8.3 D.C. Thermal Impedance Calculation

$$r_t = \sum_{p=1}^{p=n} r_p \cdot \left(1 - e^{\frac{-t}{\tau_p}} \right)$$

Where $p = 1$ to n , n is the number of terms in the series and:

- t = Duration of heating pulse in seconds.
- r_t = Thermal resistance at time t .
- r_p = Amplitude of p^{th} term.
- τ_p = Time Constant of r^{th} term.

The coefficients for this device are shown in the tables below:

D.C. Double Side Cooled				
Term	1	2	3	4
r_p	0.01021443	3.690335×10^{-3}	2.456372×10^{-3}	1.495440×10^{-3}
τ_p	0.2287021	0.08661469	0.02748645	2.550069×10^{-3}

D.C. Double Side Cooled					
Term	1	2	3	4	5
r_p	0.0344005	1.779034×10^{-3}	3.317573×10^{-3}	5.000175×10^{-3}	5.000175×10^{-4}
τ_p	1.4043858	0.9710862	0.0978218	0.03880263	1.285346×10^{-3}

9.0 Reverse recovery ratings

(i) Q_{ra} is based on 50% I_{RM} chord as shown in Fig. 1



Fig. 1

(ii) Q_{rr} is based on a $150\mu s$ integration time i.e.

$$Q_{rr} = \int_0^{150\mu s} i_{rr} \cdot dt$$

(iii) $K \text{ Factor} = \frac{t_1}{t_2}$

Curves

Figure 1 – On-State Characteristics of Limit Device

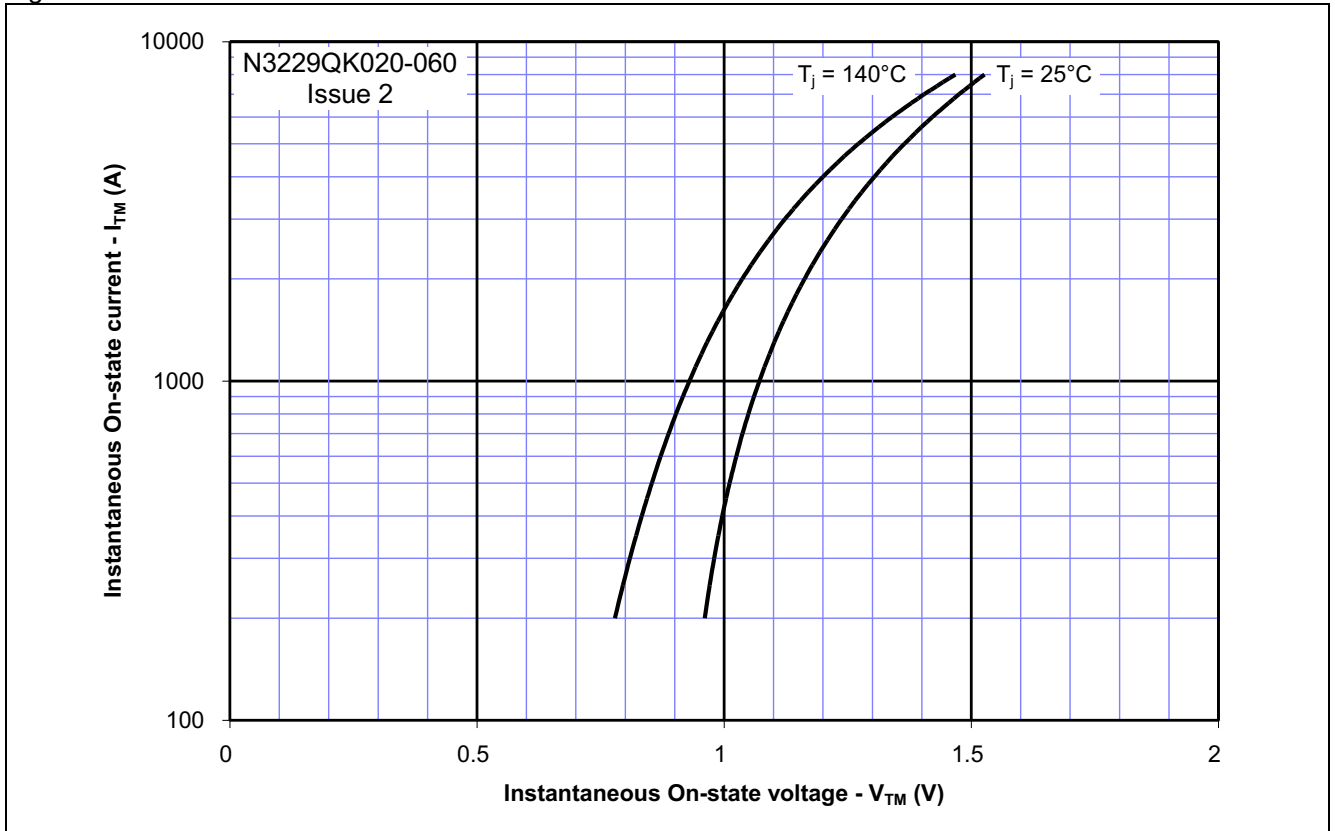

Figure 2 – Gate Characteristics – Trigger Limits

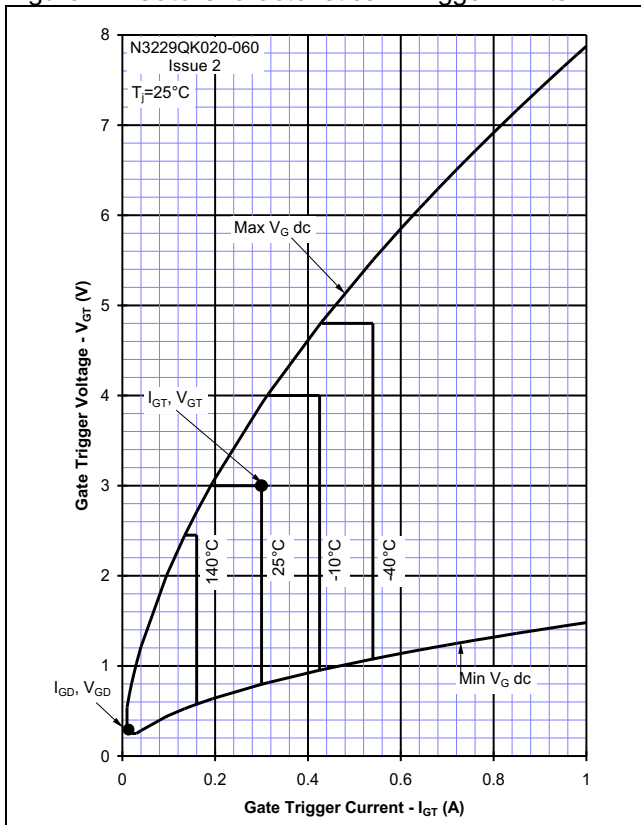

Figure 3 – Gate Characteristics – Power Curves

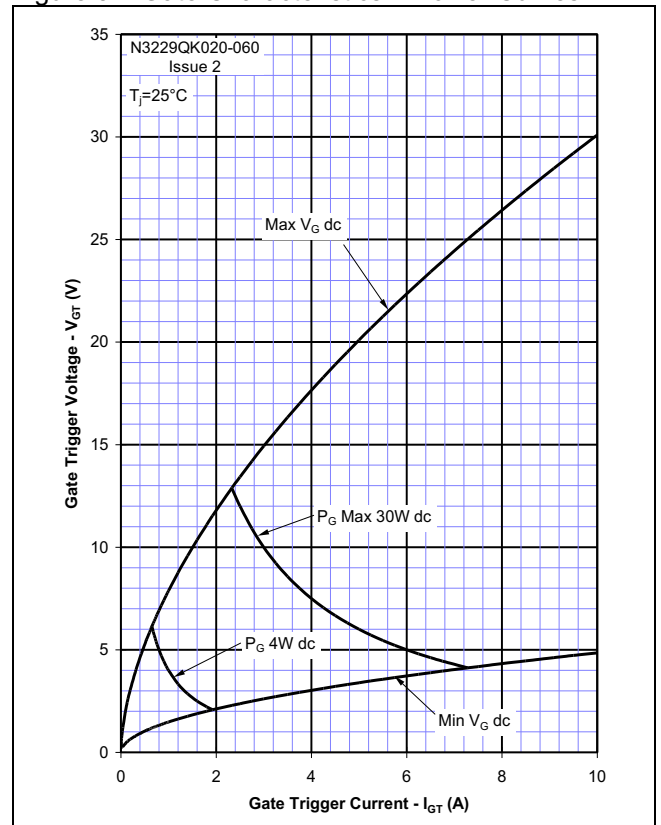

Figure 4 – Total Recovered Charge, Q_{rr}

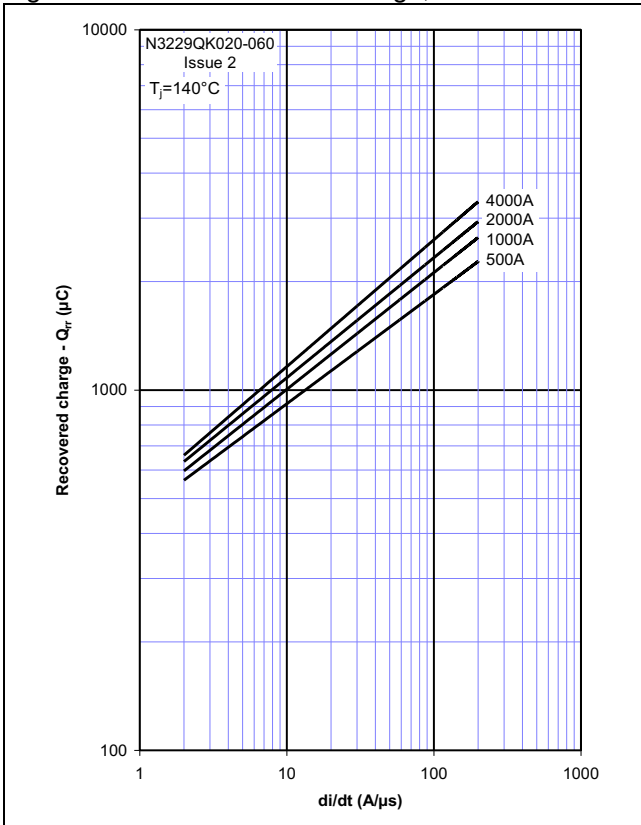

Figure 5 – Recovered Charge, Q_{ra} (50% chord)

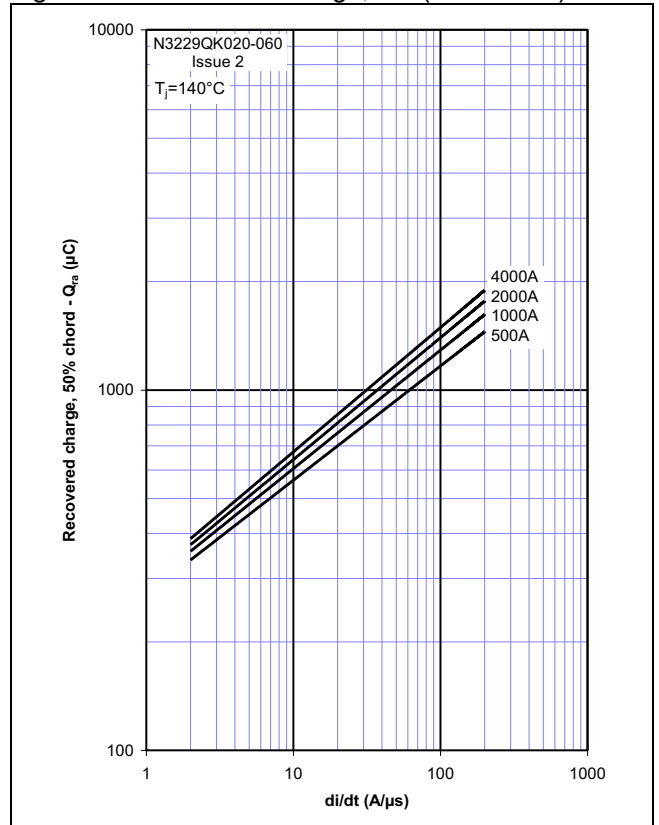

Figure 6 – Peak Reverse Recovery Current, I_{rm}

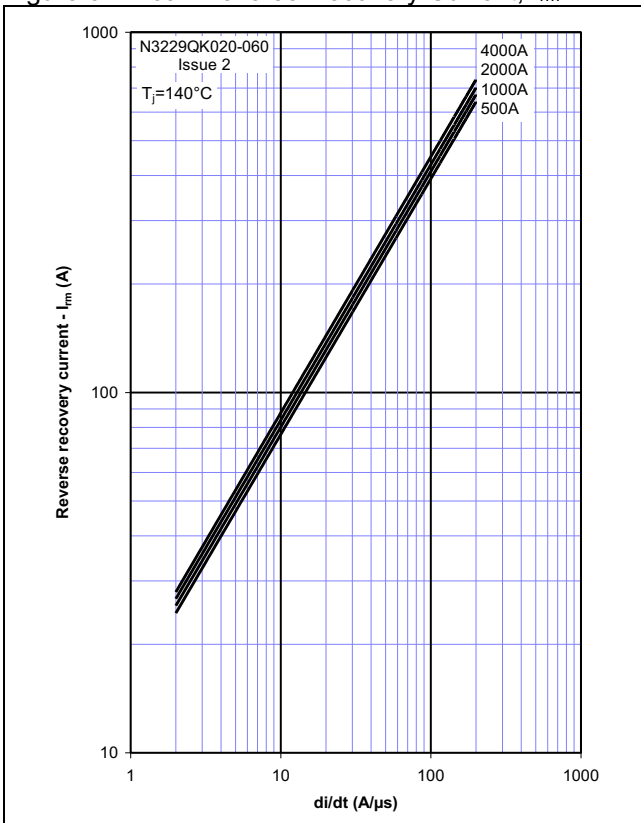

Figure 7 – Maximum Recovery Time, t_{rr} (50% chord)

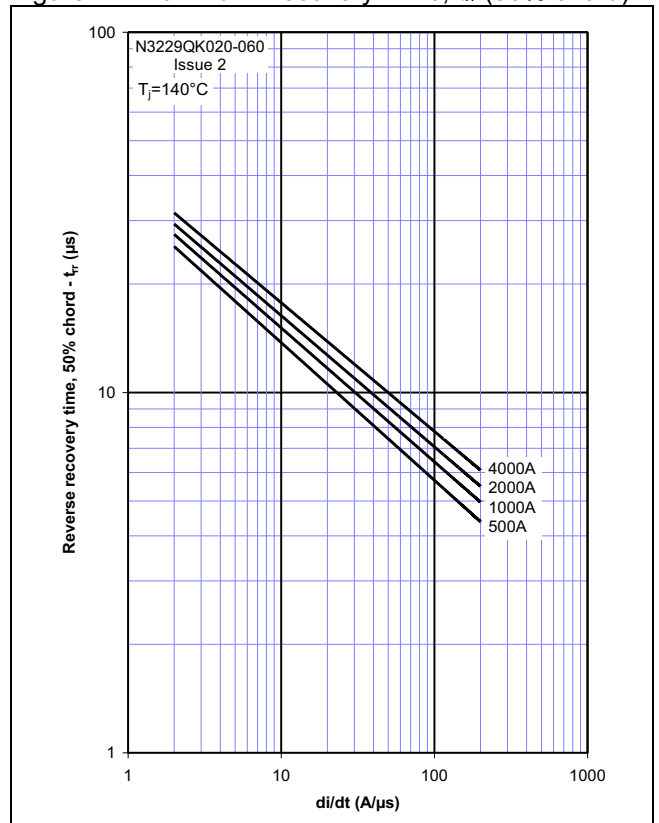

Figure 8 – On-state current vs. Power dissipation – Double Side Cooled (Sine wave)

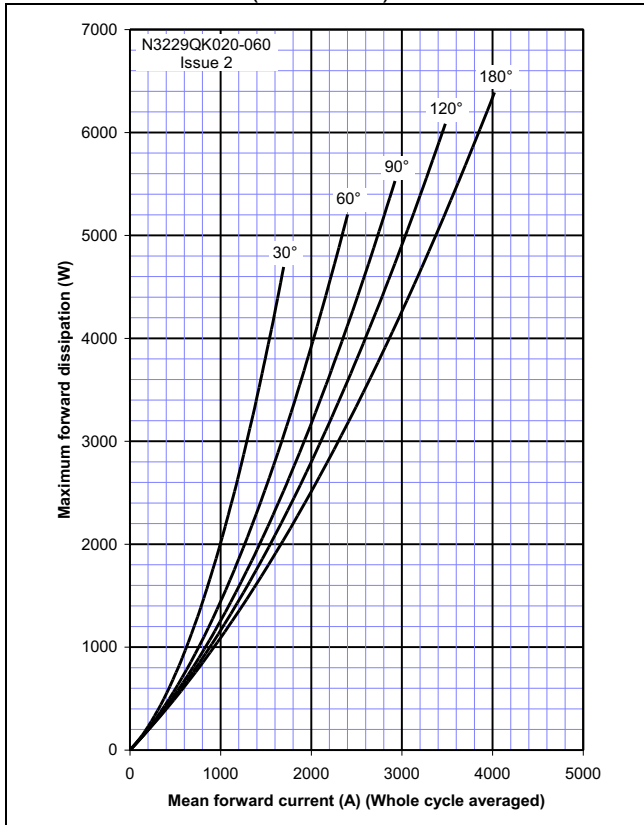

Figure 9 – On-state current vs. Heatsink temperature – Double Side Cooled (Sine wave)

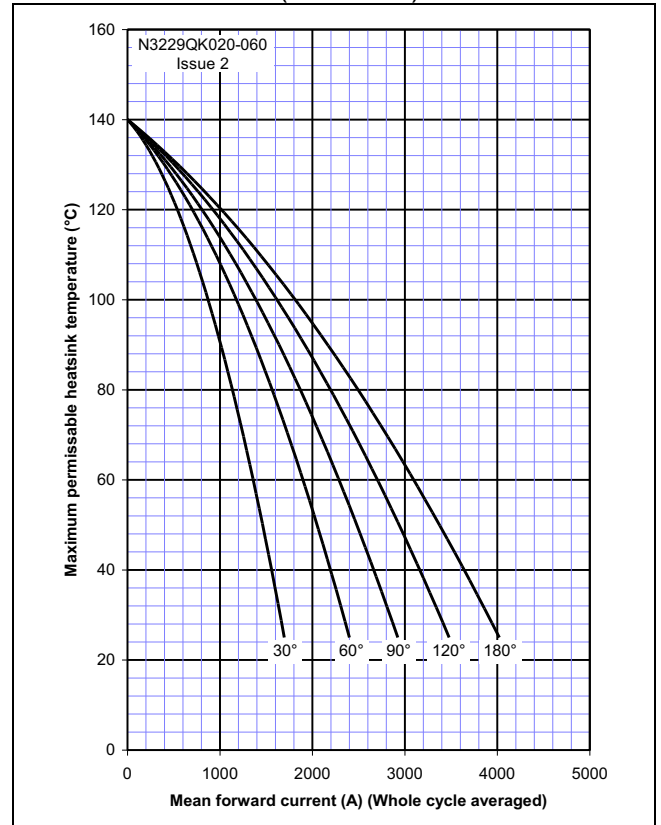

Figure 10 – On-state current vs. Power dissipation – Double Side Cooled (Square wave)

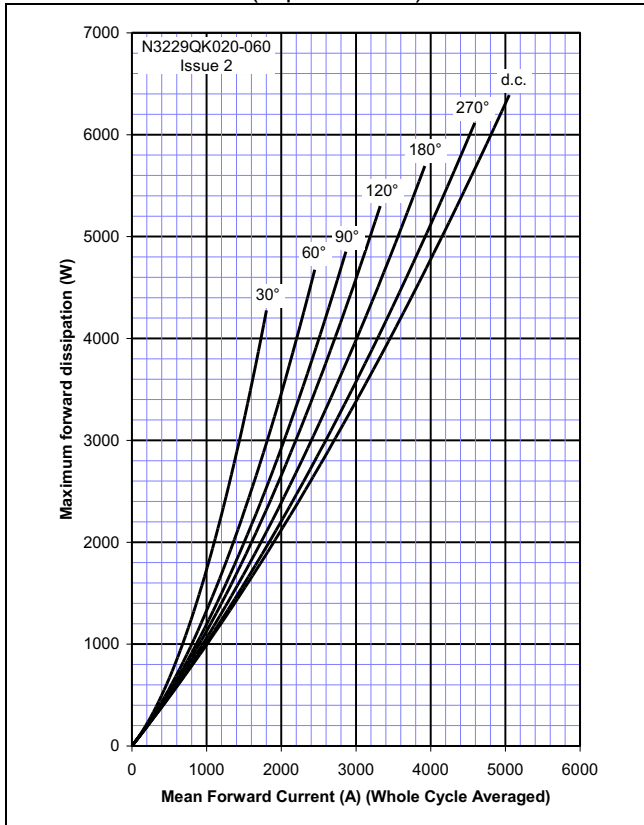

Figure 11 – On-state current vs. Heatsink temperature – Double Side Cooled (Square wave)

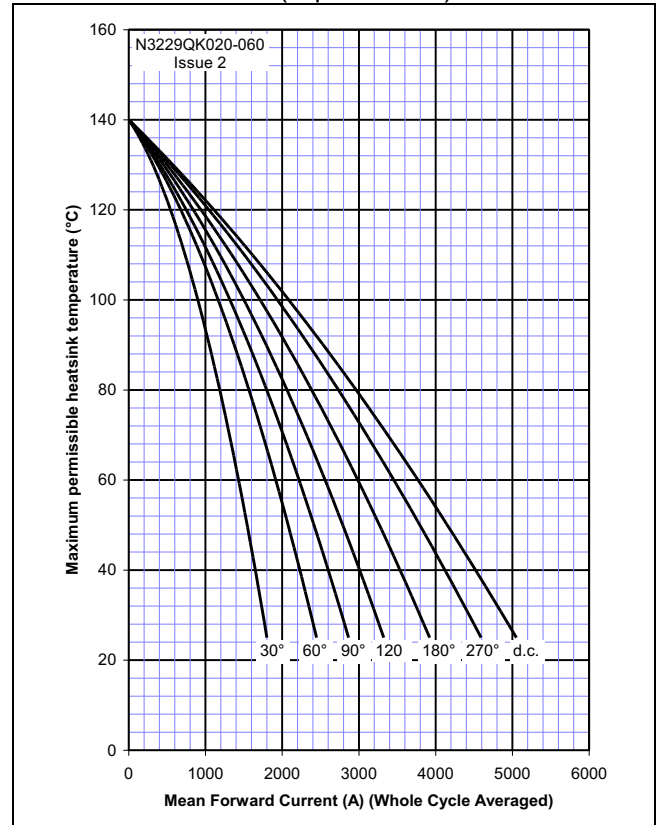

Figure 12 – On-state current vs. Power dissipation – Cathode Side Cooled (Sine wave)

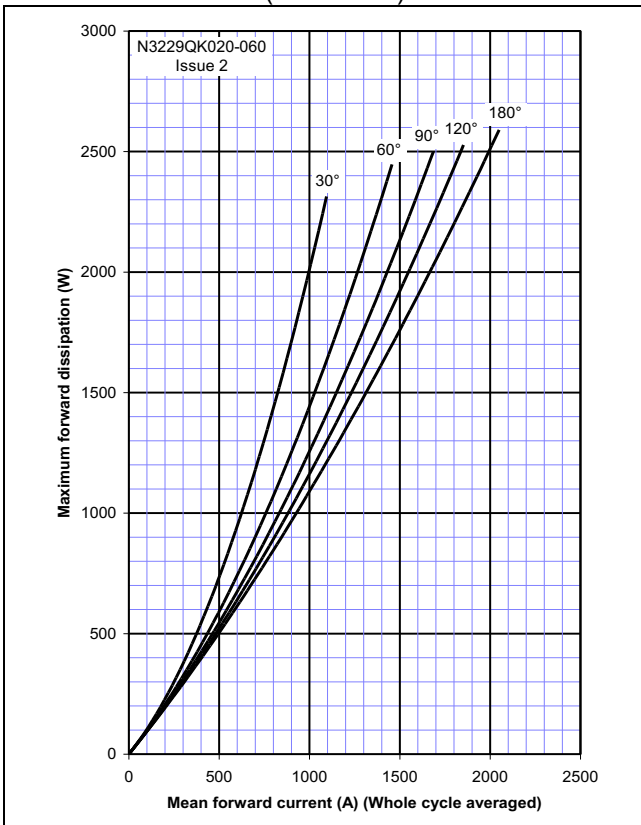

Figure 13 – On-state current vs. Heatsink temperature – Cathode Side Cooled (Sine wave)

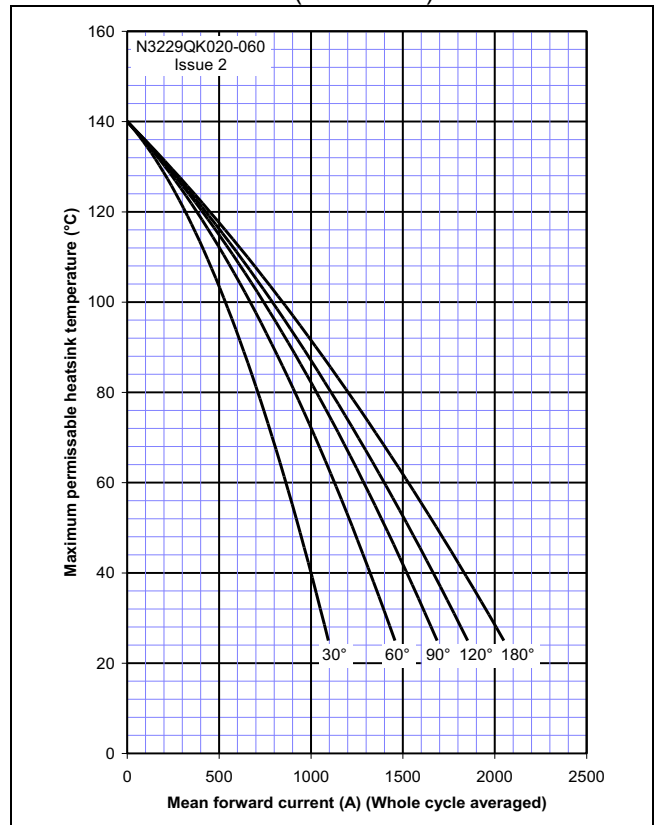

Figure 14 – On-state current vs. Power dissipation – Cathode Side Cooled (Square wave)

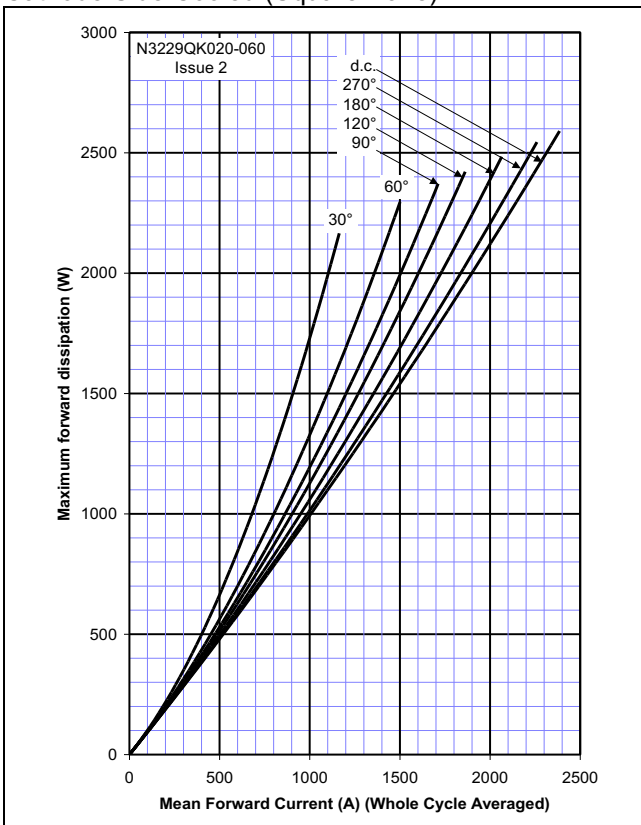

Figure 15 – On-state current vs. Heatsink temperature – Cathode Side Cooled (Square wave)

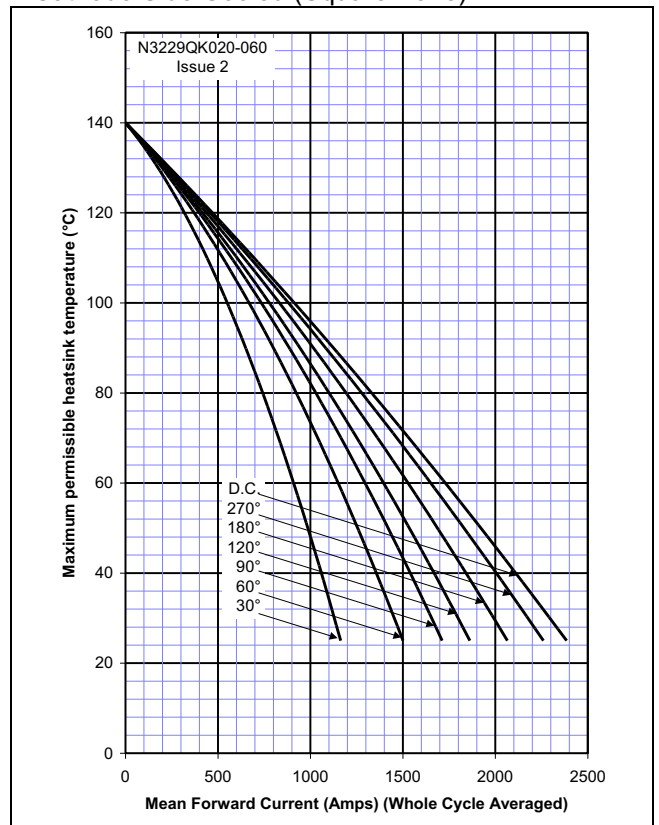

Figure 16 – Maximum Surge and I^2t Ratings

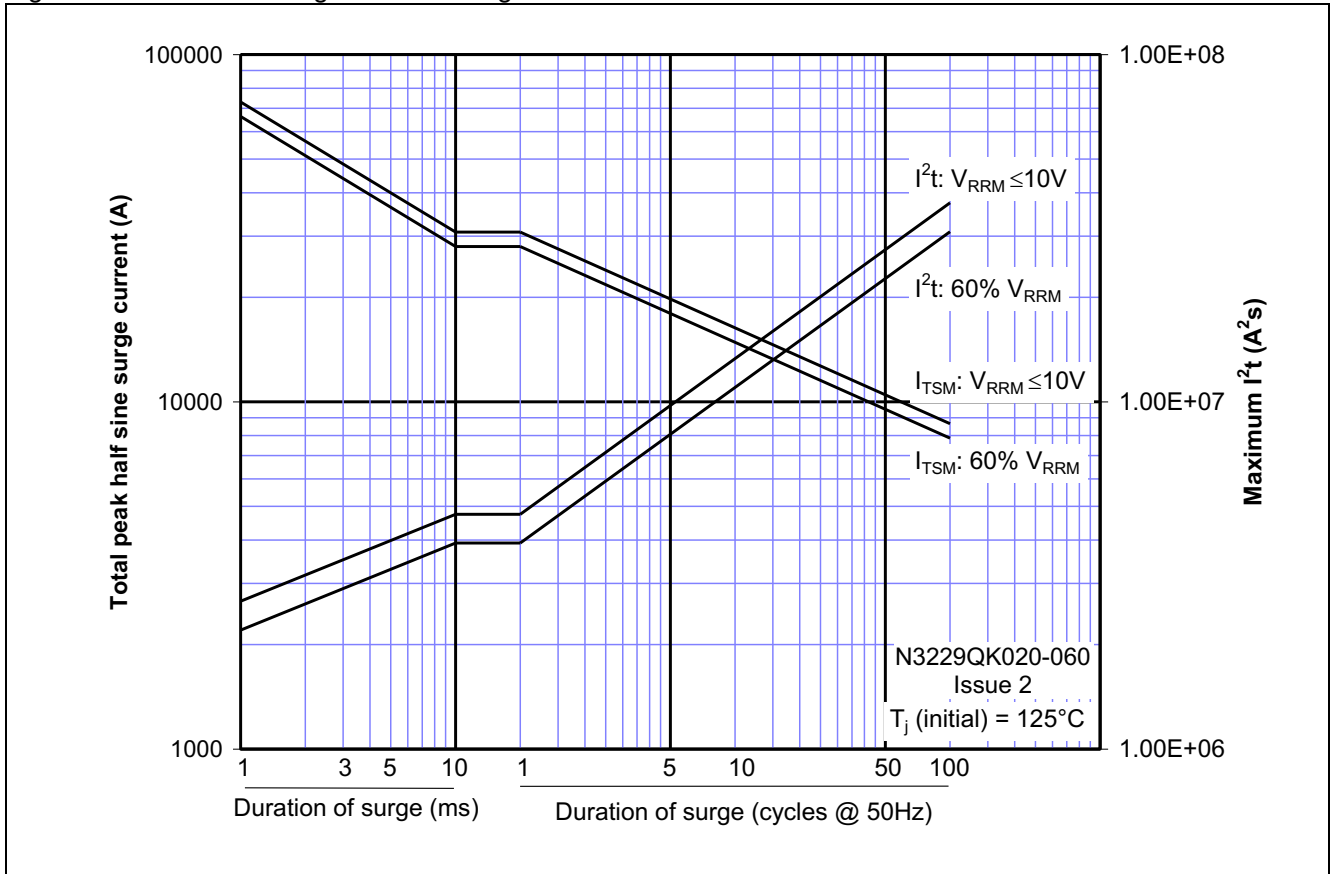
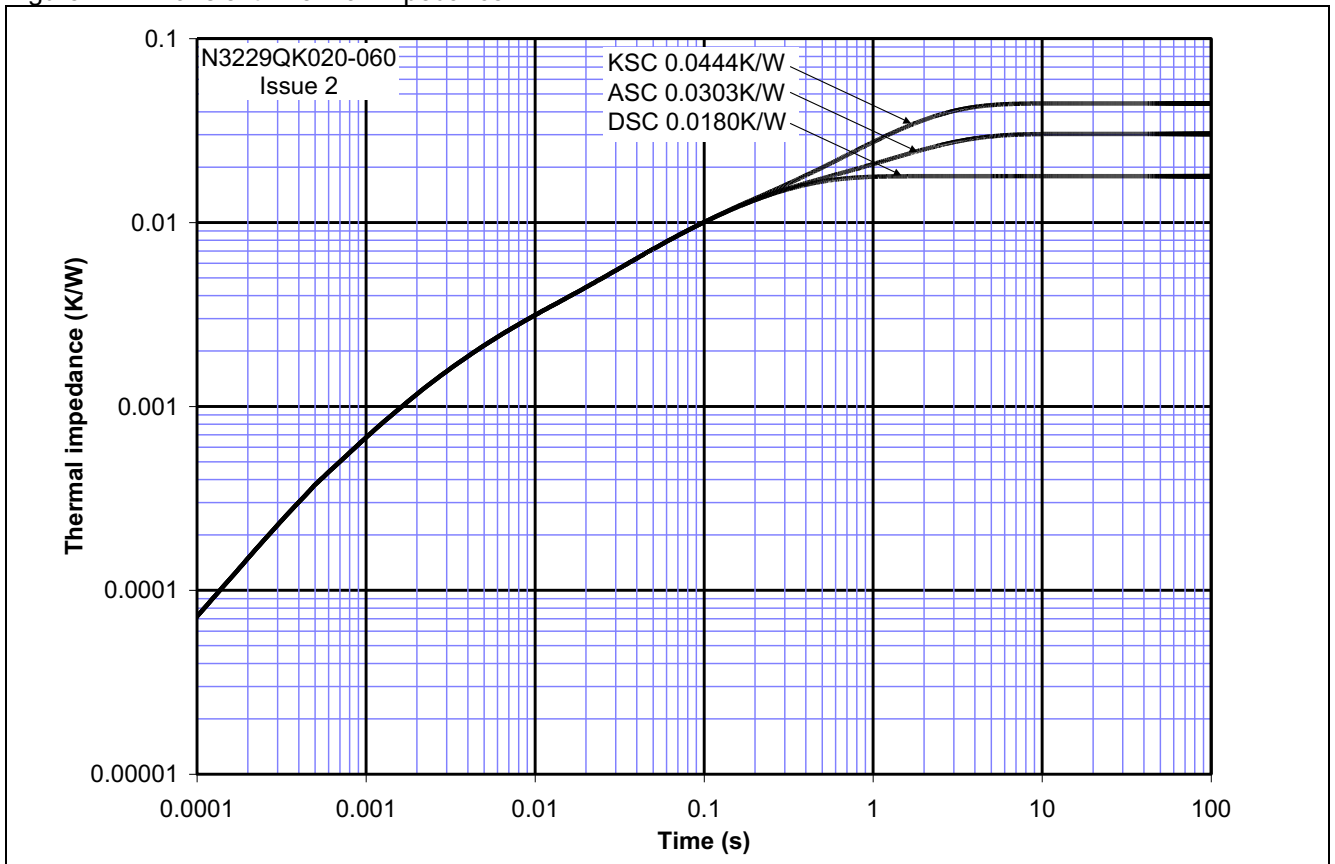
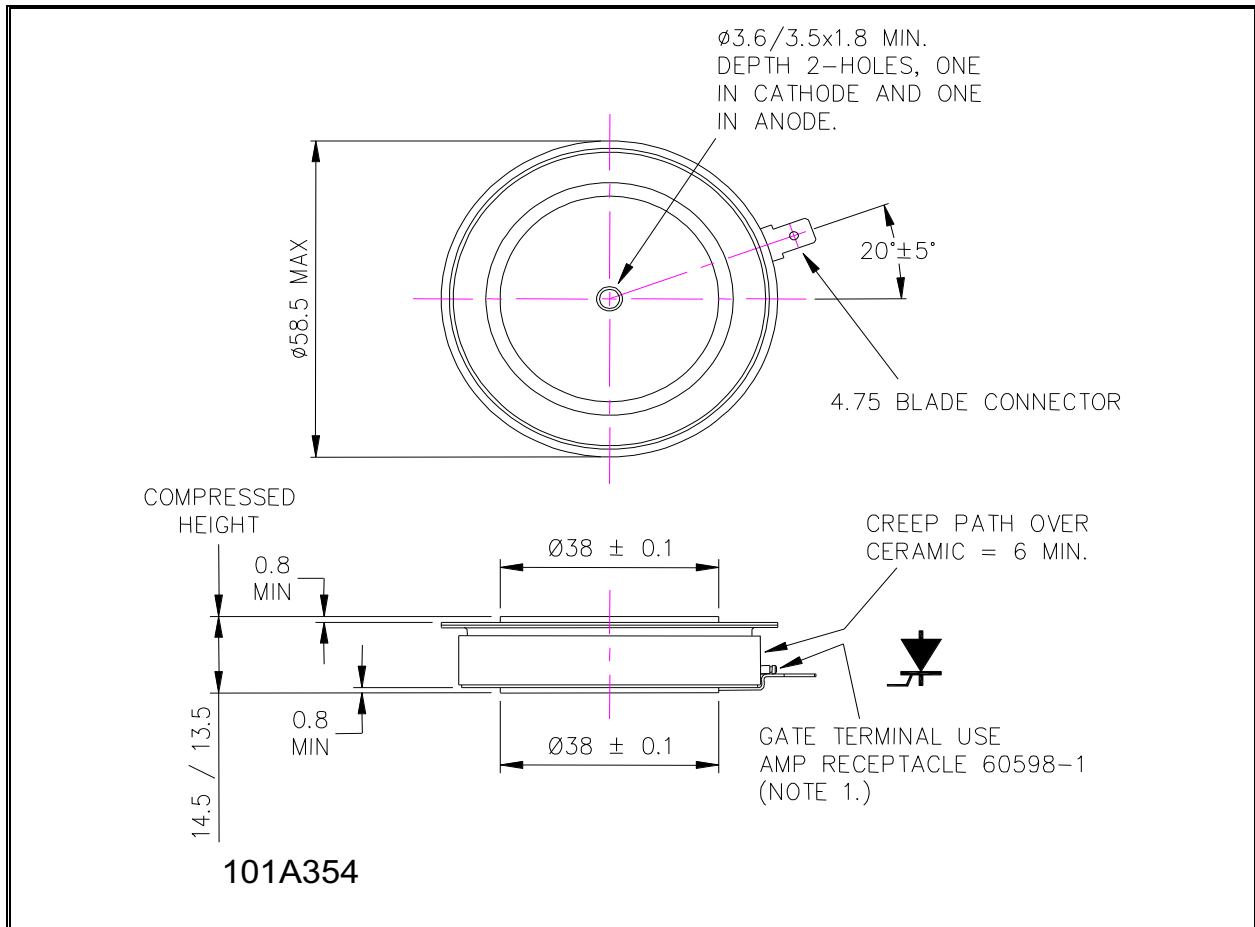

Figure 17 – Transient Thermal Impedance



Outline Drawing & Ordering Information



ORDERING INFORMATION			
(Please quote 10 digit code as below)			
N3229	QK	◆◆	0
Fixed Type Code	Fixed outline code	Voltage code $V_{DRM}/100$ 02-06	Fixed turn-off time code

Order code: N3229QK040 – 400V V_{DRM} , V_{RRM} , 14mm clamp height capsule.

<p>IXYS Semiconductor GmbH Edisonstraße 15 D-68623 Lampertheim Tel: +49 6206 503-0 Fax: +49 6206 503-627 E-mail: marcom@ixys.de</p>		<p>IXYS UK Westcode Ltd Langley Park Way, Langley Park, Chippenham, Wiltshire, SN15 1GE. Tel: +44 (0)1249 444524 Fax: +44 (0)1249 659448 E-mail: sales@ixysuk.com</p>
<p>IXYS Corporation 3540 Bassett Street Santa Clara CA 95054 USA Tel: +1 (408) 982 0700 Fax: +1 (408) 496 0670 E-mail: sales@ixys.net</p>	<p>www.ixysuk.com</p> <p>www.ixys.com</p>	<p>IXYS Long Beach IXYS Long Beach, Inc 2500 Mira Mar Ave, Long Beach CA 90815 Tel: +1 (562) 296 6584 Fax: +1 (562) 296 6585 E-mail: service@ixyslongbeach.com</p>

The information contained herein is confidential and is protected by Copyright. The information may not be used or disclosed except with the written permission of and in the manner permitted by the proprietors IXYS UK Westcode Ltd. © IXYS UK Westcode Ltd.

In the interest of product improvement, IXYS UK Westcode reserves the right to change specifications at any time without prior notice.

Devices with a suffix code (2-letter, 3-letter or letter/digit/letter combination) added to their generic code are not necessarily subject to the conditions and limits contained in this report.



Disclaimer Notice - Information furnished is believed to be accurate and reliable. However, users should independently evaluate the suitability of and test each product selected for their own applications. Littelfuse products are not designed for, and may not be used in, all applications. Read complete Disclaimer Notice at www.littelfuse.com/disclaimer-electronics.