

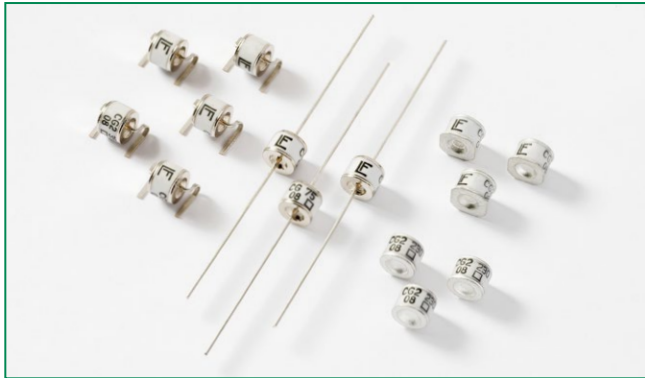

### CG/CG2 Series



#### Agency Approvals

AGENCY	AGENCY FILE NUMBER
	E128662 <sup>1</sup>
	E320116 <sup>2</sup>

**NOTES:**

1. Certified to UL 497B.
2. Only CG2300, CG2470, CG2600, CG2800 and CG221000. Certified to UL 1449.

#### 2 Electrode GDT Graphical Symbol



#### Additional Information



**Datasheet**



**Resources**



**Samples**

#### Description

Littelfuse's highly reliable CG/CG2 Series GDTs provide a high degree of surge protection in a small size ideal for board level circuit protection.

GDTs function as switches which dissipate a minimum amount of energy and therefore handle currents that far surpass other types of transient voltage protection. Their gas-filled, rugged ceramic metal construction make them well suited to adverse environments.

The CG/CG2 series comes in a variety of forms including surface mount, core, straight and shaped leads, to serve a variety of mounting methods.

The CG Series (75V-110V) is ideal for protection of test and communication equipment and other devices in which low voltage limits and extremely low arc voltages are required.

The CG2 Series (145V-1000V) is ideal for protecting equipment where higher voltage limits and holdover voltages are necessary.

#### Features

- RoHS and Lead-free compliant
- Rugged Ceramic-Metal construction
- Low Capacitance (<1.5pf)
- Meets REA PE-80
- Available in surface mount, and a variety of lead options options
- RoHS Compliant and Lead-Free

#### Applications

- Communication lines and equipment
- CATV equipment
- Test equipment
- Data lines
- Power supplies
- Instrumentation circuits
- Medical electronics
- ADSL equipment
- Telecom SLIC protection

### Electrical Characteristics

Part Number	Device Specifications (at 25°C)						Life Ratings							
	DC Breakdown in Volts (@100V/s)			Impulse Break-down in Volts (@100V/μs)	Impulse Break-down In Volts (@1 Kv/μsec)	Insulation Resistance	Capacitance (@1MHz)	Arc Voltage (on state Voltage) @1Amp Min	Surge Life (@500A 10/1000μs)	Nominal Impulse Discharge Current (8/20μs)	Nominal AC Discharge Current (10x1sec @50-60Hz)	AC Discharge Current (9 cycle @50Hz)	DC Holdover Voltage <sup>2</sup>	Max Impulse Discharge Current (1 Application @ 10/350μs)
	MIN	TYP	MAX	MAX		MIN	MAX	TYP					TYP	
CG75	60	75	90	400	650	10 <sup>10</sup> Ω (at 50V)	1.5 pf	15 V	400 shots	5 shots (@20kA)	20 A	100 A	52 V	4kA
CG90	72	90	108	400	600									
CG90 SN	72	90	108	400	600									
CG110	88	110	132	450	600									
CG2145	116	145	174	500	600									
CG2145 SN	120	145	174	500	600									
CG2230 <sup>1</sup>	195	230	265	600	700									
CG2230 SN <sup>1</sup>	184	230	276	600	700									
CG2250	213	250	288	625	725									
CG2250 SN	200	250	300	625	725									
CG2300	255	300	345	700	800									
CG2300 SN	240	300	360	700	800									
CG2350	297	350	403	750	900									
CG2350 SN	280	350	420	750	900									
CG2420	357	420	483	800	1000									
CG2470 <sup>1</sup>	400	470	540	850	1200									
CG2470 SN <sup>1</sup>	376	470	564	850	1200									
CG2600 <sup>1</sup>	510	600	690	1000	1400									
CG2600 SN <sup>1</sup>	480	600	720	1000	1400									
CG2800 <sup>1</sup>	680	800	920	1200	1500									
CG21000 <sup>1</sup>	850	1000	1150	1500	1600									
						10 <sup>10</sup> Ω (at 100V)				10 shots (@10kA)	10 A	65 A	135 V	2.5kA

NOTES:

- Certified to UL 1449.
- Reference REA PE-80, 0.2A. Tested to ITU-T Rec K.12 and REA PE 80 < 150 mSec.
- 5 x [5 (+) or 5 (-)] applications 20kA 8/20μSec. (75 to 600 volt devices.)  
10 x [5 (+) and 5 (-)] applications 10kA 8/20μSec. (800 and 100 volt devices.)

### Product Characteristics

<b>Materials</b>	<b>LS, Axial:</b> Device: Tin Plated 2–5 Microns Lead Wires: Tin Plated 17.5 ± 12.5 Microns Construction: Ceramic Insulator	<b>Glow to arc transition current</b>	< 0.5Amps
	<b>Core:</b> Device: Tin Plated 17.5 ± 12.5 Microns. Construction: Ceramic Insulator	<b>Glow Voltage</b>	60-160 Volts
<b>Product Marking</b>	<b>MS:</b> Device: Dull Tin Plated 7–9 Microns Construction: Ceramic Insulator	<b>Storage and Operational Temperature</b>	-40 to +90
	LF Logo, Voltage and date code; Black in positive print	<b>Maximum Follow On Current<sup>1</sup></b>	230 Volts r.m.s, 200 Amps. (800V and 1000V devices tested to UL1449 3rd edition)

### Device Dimensions

#### Leaded 'L' Type Straight Axial Devices

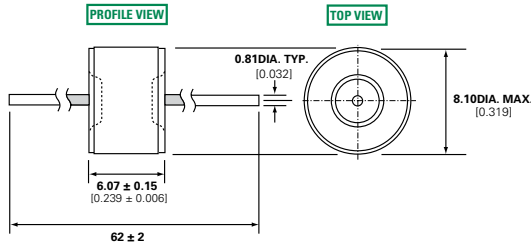

#### Leaded 'LS' Type Shaped Lead Devices

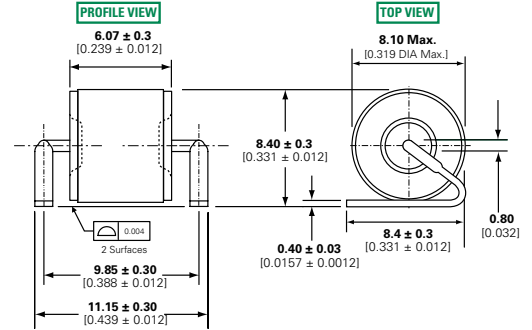

#### Core Devices

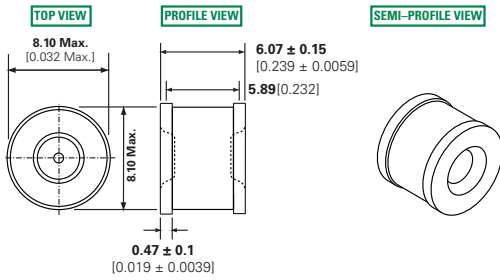

#### SOLDER PAD LAYOUT

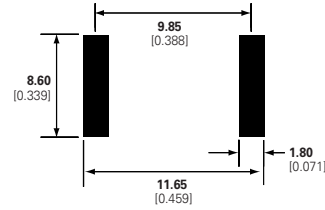

#### 'MS' Type Devices

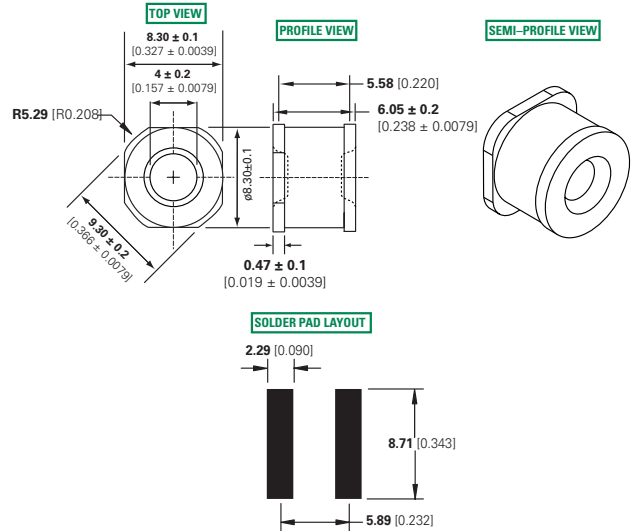

**Soldering Parameters - Reflow Soldering (Surface Mount Devices)**

Reflow Condition		Pb – Free assembly
Pre Heat	- Temperature Min ( $T_{s(min)}$ )	150°C
	- Temperature Max ( $T_{s(max)}$ )	200°C
	- Time (Min to Max) ( $t_s$ )	60 – 180 secs
Average ramp up rate (Liquidus Temp ( $T_L$ ) to peak)		3°C/second max
$T_{s(max)}$ to $T_L$ - Ramp-up Rate		5°C/second max
Reflow	- Temperature ( $T_L$ ) (Liquidus)	217°C
	- Temperature ( $t_L$ )	60 – 150 seconds
Peak Temperature ( $T_p$ )		260 <sup>+0/-5</sup> °C
Time within 5°C of actual peak Temperature ( $t_p$ )		10 – 30 seconds
Ramp-down Rate		6°C/second max
Time 25°C to peak Temperature ( $T_p$ )		8 minutes Max.
Do not exceed		260°C

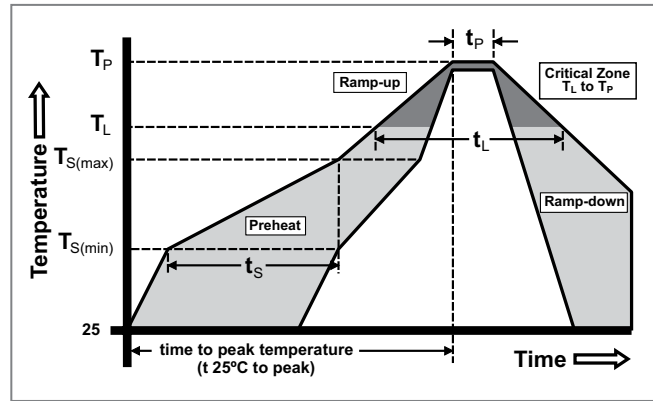

**Soldering Parameters - Wave Soldering (Thru-Hole Devices)**



**Recommended Process Parameters:**

Wave Parameter	Lead-Free Recommendation
<b>Preheat:</b> (Depends on Flux Activation Temperature) (Typical Industry Recommendation)	
Temperature Minimum:	100° C
Temperature Maximum:	150° C
Preheat Time:	60-180 seconds
<b>Solder Pot Temperature:</b>	280° C Maximum
<b>Solder Dwell Time:</b>	2-5 seconds

**Soldering Parameters - Hand Soldering**

Solder Iron Temperature: 350° C +/- 5°C  
Heating Time: 5 seconds max.

**Packaging Dimensions**

**For 'L' Type Axial Lead Items**

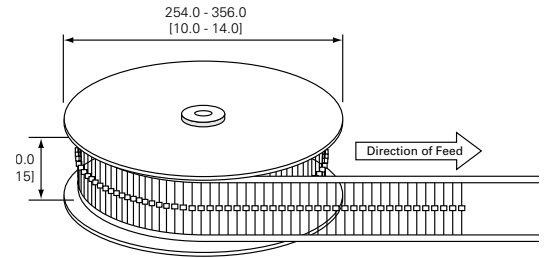

**Core and 'MS' Type Items**

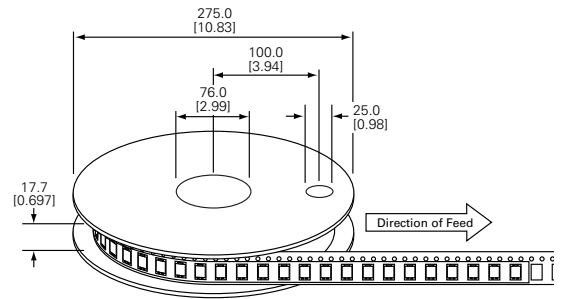
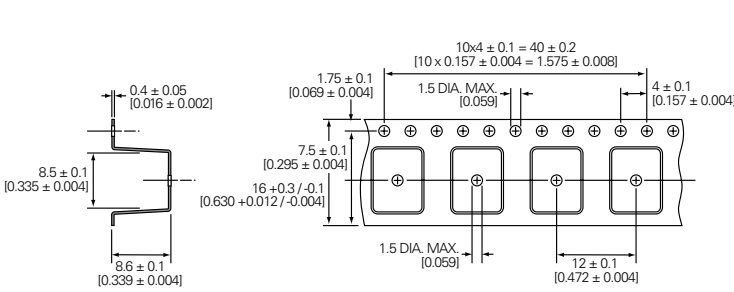

**For 'LS' Type Shaped Lead Items**

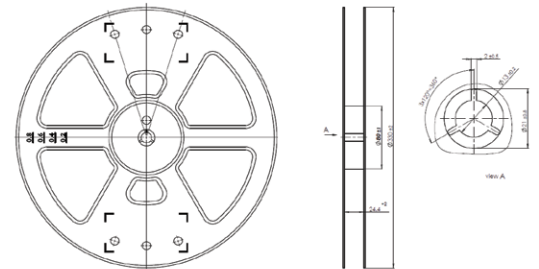
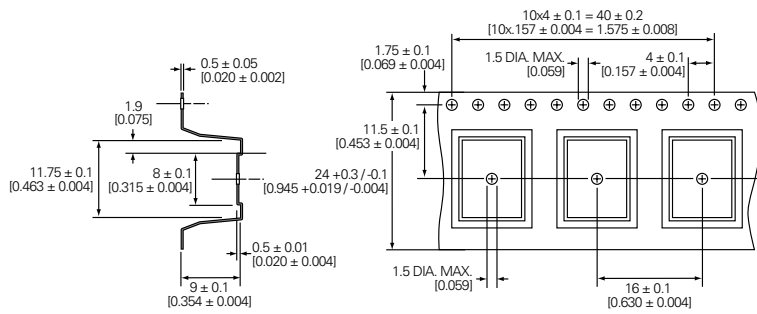

### Part Numbering System and Ordering Information

**CG2 XXX XX \* XX**

**Series**

**CG** – for 75, 90, or 110V  
**CG2** – for 145V to 1000V

**Breakdown Voltage**

75	300
90	350
110	470
145	600
230	800
250	1000

**Lead Option Code**

(Blank) = No Leads / Core  
**L** = Straight Leads  
**LS** = Shaped Leads  
**MS** = Surface Mount

**Option Code\***

SN = may have different DC Breakover Voltage Limit. Please refer to Electrical Characteristics table for additional information.

**Packaging Option Code**

(Blank) = No Leads / Core, Bulk Bag - 400 pcs  
 L(Blank) = Straight Lead, Tray - 50 pcs  
**LTR** = Straight Lead, Tape & Reel per EIA RS-296-E - 500 per reel  
 LS(Blank) = Shaped Lead (see LS dimensions), Tape & Reel - 500 per reel

**Examples:**

- CG75** – A non-leaded 75V device
- CG2230L** – A leaded 230V device
- CG2800LTR** – A leaded 800V device, tape-and-reel (per EIA standard RS-296-D)

**Notes:**

CG/CG2 devices with other breakdown voltages in the 75-1000 V range are available upon request.