

ITV4030 12A/15A/22A Series

Surface Mount

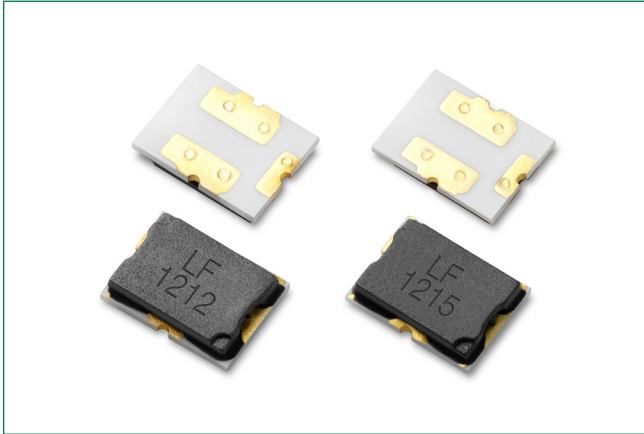

Description

ITV4030 Series is a three terminals surface mountable battery protector which is designed to protect against both overcurrent and overvoltage (overcharging). A fuse element is embedded to cut off the circuit when overcurrent issue happens. A heater is also directly embedded under the fuse element, it will generate heat to blow the fuse once overvoltage detected by IC or FET.

Features

- Halogen Free
- Surface Mount
- Fast response
- Protection for both overcurrent and overcharging

Agency Approvals

Agency	Agency File Number	Ampere Range
cULUS	E10480	12 A, 15 A, 22 A
△	TA 50461285	12 A, 15 A, 22 A

Thermal Derating Characteristics

Ambient Operating Temperature		25° C	40° C	60° C
Recommend Rated Current (A)	ITV4030 12 A Series	13.5	12.0	10.0
	ITV4030 15 A Series	18.0	16.0	13.5
	ITV4030 22 A Series	24.0	22.0	18.0

Applications

- Two-way radio
- eCall
- Tablet PC
- Vacuum cleaner
- Power tools

Electrical Characteristics

Part Number	Ordering Code	I _{rated} (A)	Cell in Series	V _{max} (Vdc)	I _{break} (A)	V _{OP} (V)	Resistance		Agency Approvals	
							R _{heater} (Ω)	R _{fuse} (mΩ)	cULUS	△
ITV4030L0412	ITV4030L0412NR	12	1	36	50	3.0 ~ 4.5	0.6 ~ 1.5	1.5 ~ 3.5	X	X
ITV4030L0812	ITV4030L0812NR	12	2	36	50	4.0 ~ 9.0	2.0 ~ 3.2	1.5 ~ 3.5	X	X
ITV4030L1212	ITV4030L1212NR	12	3	36	50	7.4 ~ 13.8	5.7 ~ 9.9	1.5 ~ 3.5	X	X
ITV4030L1412	ITV4030L1412NR	12	4	36	50	10.5 ~ 19.6	11.2 ~ 20.0	1.5 ~ 3.5	X	X
ITV4030L0415	ITV4030L0415NR	15	1	36	50	3.0 ~ 4.5	0.6 ~ 1.5	1.0 ~ 3.0	X	X
ITV4030L0815	ITV4030L0815NR	15	2	36	50	5.0 ~ 9.0	2.2 ~ 3.3	1.0 ~ 3.0	X	X
ITV4030L1215	ITV4030L1215NR	15	3	36	50	7.4 ~ 13.8	5.5 ~ 8.4	1.0 ~ 3.0	X	X
ITV4030L1415	ITV4030L1415NR	15	4	36	50	10.5 ~ 19.6	10.4 ~ 15.8	1.0 ~ 3.0	X	X
ITV4030L2015	ITV4030L2015NR	15	5	36	50	14.4 ~ 23.5	17.9 ~ 29.1	1.0 ~ 3.0	X	X
ITV4030L2415	ITV4030L2415NR	15	6	36	50	16.8 ~ 28.0	28.9 ~ 43.4	1.0 ~ 3.0	X	X
ITV4030L0422	ITV4030L0422NR	22	1	36	50	3.5 ~ 4.7	0.55 ~ 1.3	0.5 ~ 2.5	X	X
ITV4030L0822	ITV4030L0822NR	22	2	36	50	6.0 ~ 9.2	2.1 ~ 3.8	0.5 ~ 2.5	X	X
ITV4030L1222	ITV4030L1222NR	22	3	36	50	9.0 ~ 13.8	4.8 ~ 8.6	0.5 ~ 2.5	X	X
ITV4030L1422	ITV4030L1422NR	22	4	36	50	12.0 ~ 18.5	8.6 ~ 15.2	0.5 ~ 2.5	X	X
ITV4030L2022	ITV4030L2022NR	22	5	36	50	15.9 ~ 23.1	13.5 ~ 26.7	0.5 ~ 2.5	X	X
Current Capacity	100% x I _{rated} , No Melting									
Cut Time	200% x I _{rated} , < 1 min									
Interrupting Current	5 x I _{rated} , power on 5 ms, power off 995 ms, 10000 cycles, No Melting									
Over Voltage Operation	In operation voltage range, the fusing time is <1min									

Notes:

I_{rated} = Current carrying capacity that is measured at 40°C thermal equilibrium condition
 I_{break} = The current that the fuse element is able to interrupt
 V_{max} = The maximum voltage that can be cut off by fuse
 V_{OP} = Range of operation voltage
 R_{heater} = The resistance of the heating element
 R_{fuse} = The resistance of the fuse element
 Cells in series = Number of battery cells connected in series in the circuit for ITV device to protect.

- Value specified is determined by using the PWB with 2mm*2oz copper traces, AWG18 covered wire, and 0.6mm glass epoxy PCB for ITV4030 12A Series.
- Value specified is determined by using the PWB with 2mm*2oz copper traces, AWG14 covered wire, and 0.6mm glass epoxy PCB for ITV4030 15A Series.
- Value specified is determined by using the PWB with 6mm*2oz copper traces, AWG14 covered wire, and 0.6mm glass epoxy PCB for ITV4030 22A Series.
- Specifications are subject to change without notice.

ITV4030 12A/15A/22A Series

Surface Mount

Cut Time by Heater Operation (ITV4030 12A series)

Various heater wattage at 25°C ambient temperature

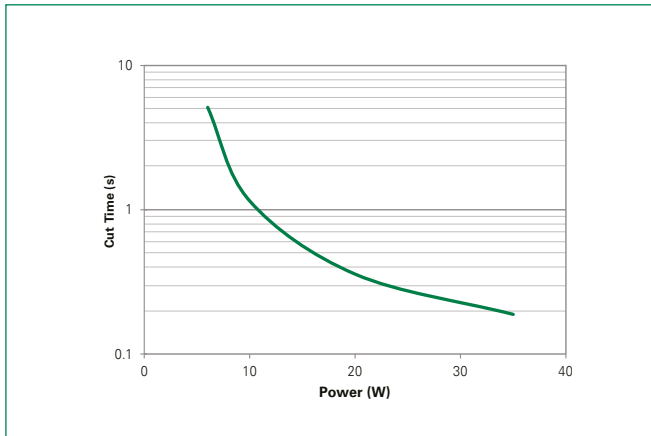

Constant heater wattage at various ambient temperature

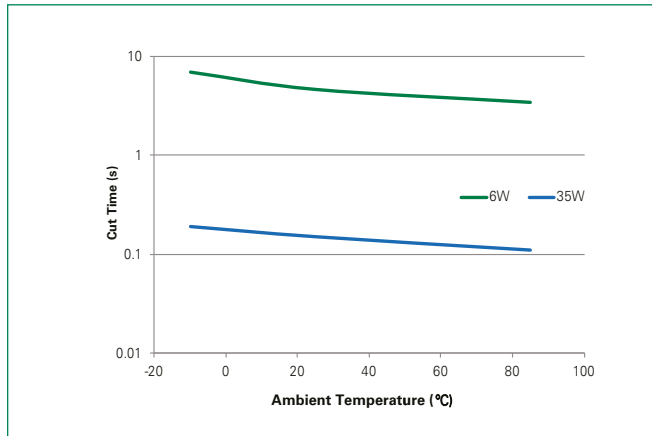

Cut Time by Heater Operation (ITV4030 15A series)

Various heater wattage at 25°C ambient temperature

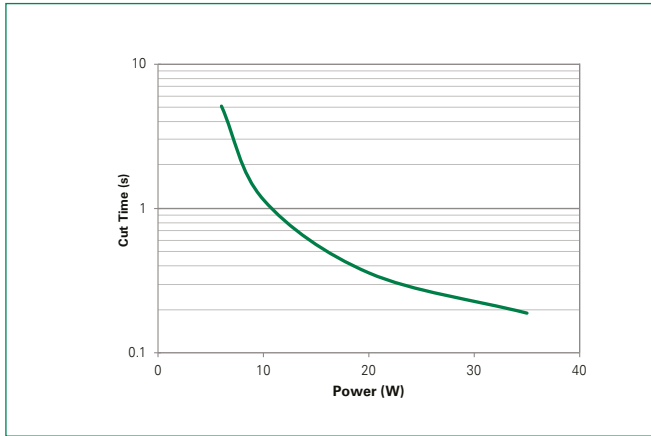

Constant heater wattage at various ambient temperature

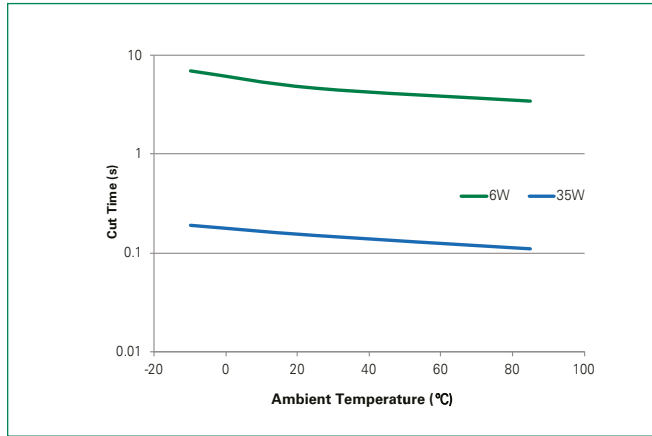

Cut Time by Heater Operation (ITV4030 22A series)

Various interrupting current at 25°C ambient temperature

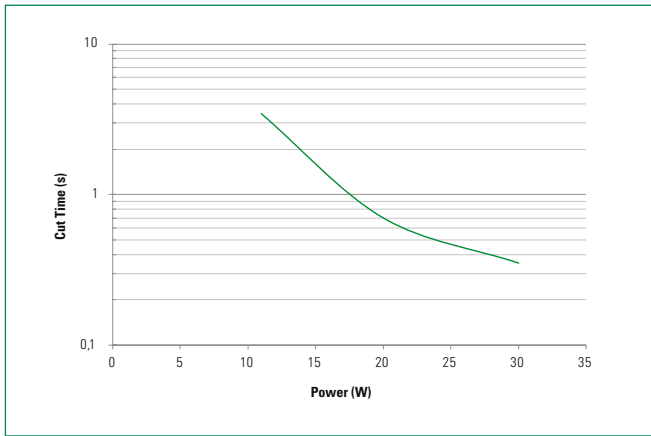

Constant 2x rated current at various ambient temperature

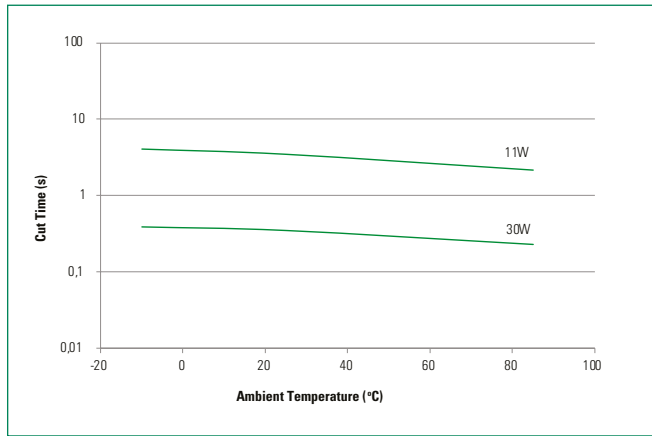

ITV4030 12A/15A/22A Series

Surface Mount

Cut Time by Current Operation (ITV4030 12A series)

Various interrupting current at 25°C ambient temperature

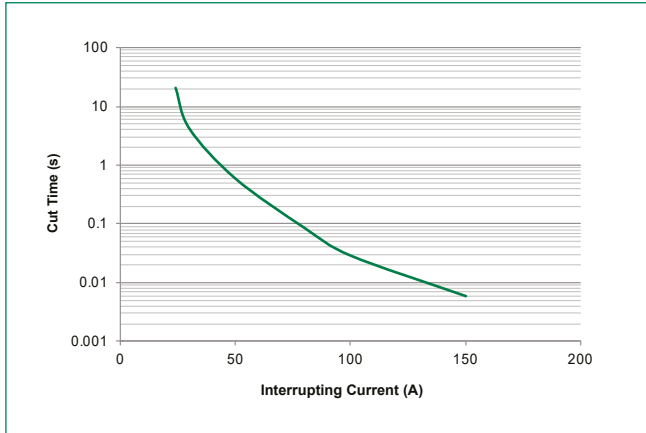

Constant 2x rated current at various ambient temperature

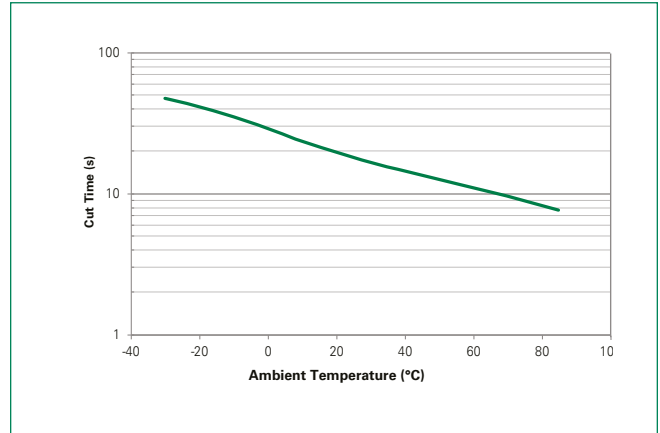

Cut Time by Current Operation (ITV4030 15A series)

Various interrupting current at 25°C ambient temperature

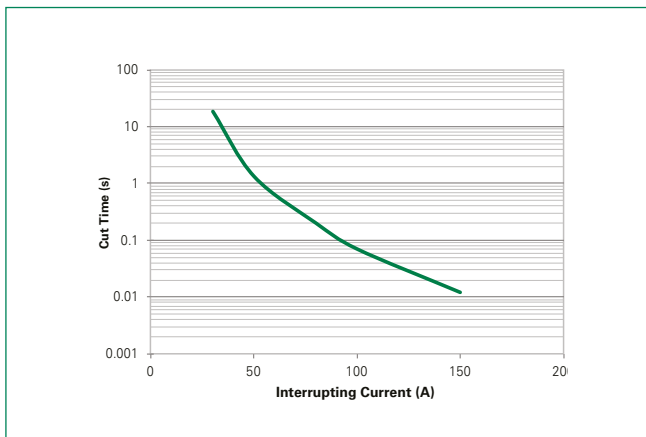

Constant 2x rated current at various ambient temperature

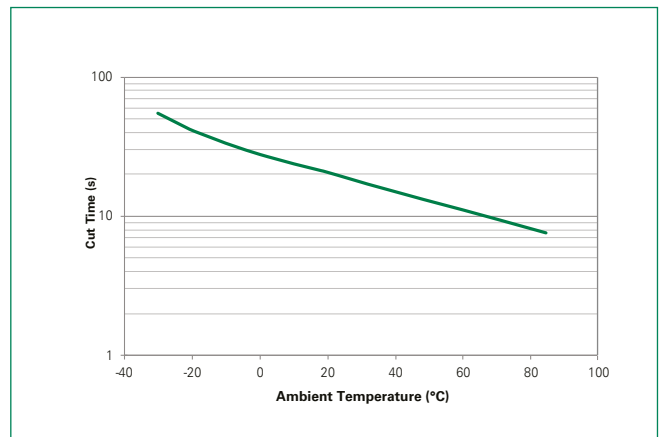

Cut Time by Current Operation (ITV4030 22A series)

Various interrupting current at 25°C ambient temperature

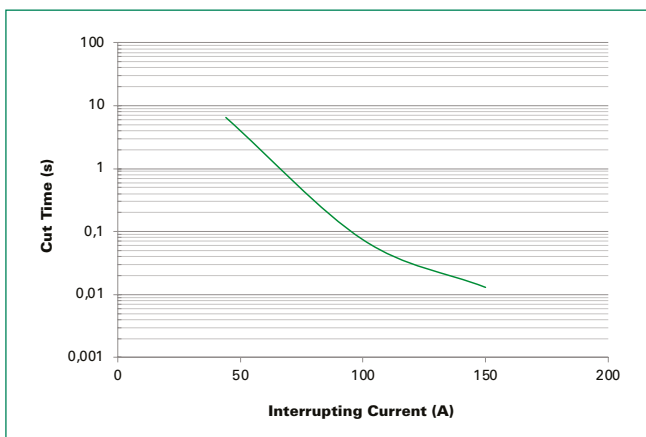

Constant 2x rated current at various ambient temperature

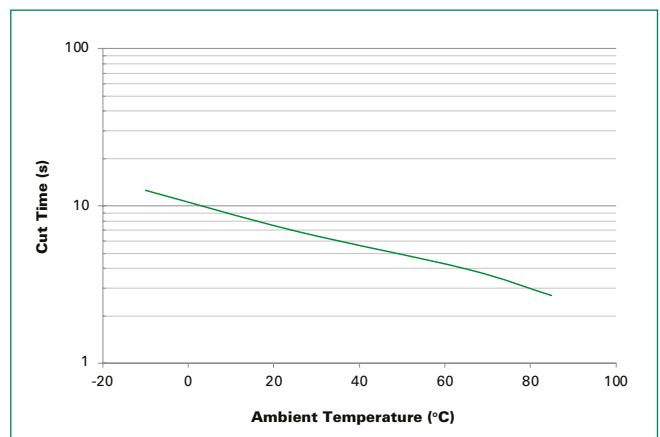

ITV4030 12A/15A/22A Series

Surface Mount

Environmental Specifications

Storage Temperature	0~35°C, ≤70%RH Shelf life: 1 year
Operating Temperature	-10°C to +65°C
Hot Passive Aging	100±5°C, 250 hours No structural damage and functional failure
Humidity Aging	60°C±2°C, 90~95% R.H. 250 hours No structural damage and functional failure
Cold Passive Aging	-20±3°C, 500 hours No structural damage and functional failure

Device Circuit

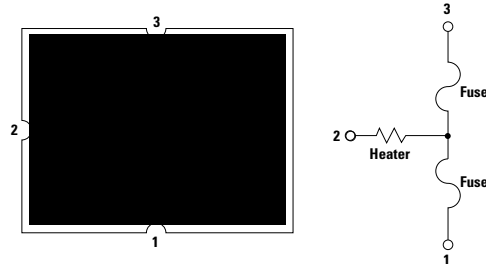

Physical Dimension (mm)

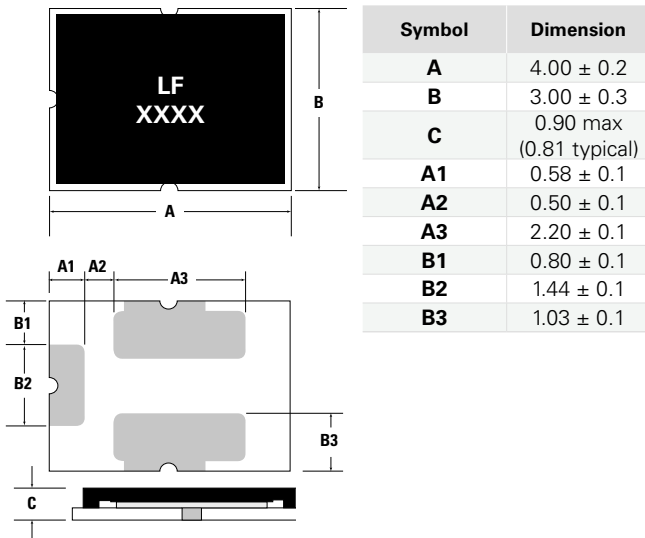

Board and Solder Layout Recommend (mm)

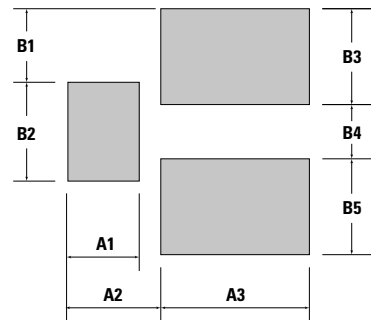

Symbol	Dimension
A1	1.20 ± 0.1
A2	1.55 ± 0.1
A3	2.40 ± 0.1
B1	1.20 ± 0.1
B2	1.60 ± 0.1
B3	1.55 ± 0.1
B4	0.90 ± 0.1
B5	1.55 ± 0.1

Soldering Parameters

Average Ramp-Up Rate (Ts_{max} to TP)	3°C/second max.	
Preheat	Temperature Min (Ts_{min})	150°C
	Temperature Max (Ts_{max})	200°C
	Time (Ts_{min} to Ts_{max})	60-120 seconds
Time maintained above:	Temperature (T_L)	217°C
	Time (t_L)	60-105 seconds
Peak Temperature (T_P)	255°C	
Time within 5°C of actual Peak Temperature (t_p)	5 seconds max.	
Ramp-Down Rate	6°C/second max.	
Time 25°C to Peak Temperature	8 minutes max.	

Physical Specifications

Material	Glass Epoxy PCB
Base Thickness	0.6mm
Copper Thickness	0.07mm
Covered Wire	AWG18 (ITV4030 12A Series)
	AWG14 (ITV4030 15A/22A Series)

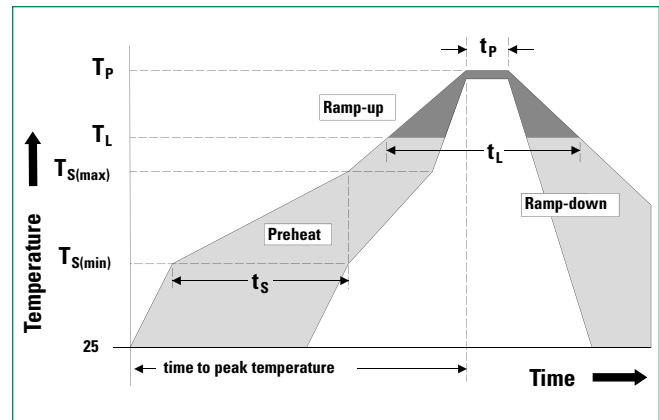

- All temperature refer to topside of the package, measured on the package body surface
 - If reflow temperature exceeds the recommended profile, devices may not meet the performance requirements

ITV4030 12A/15A/22A Series

Surface Mount

Typical Application Circuit Diagram

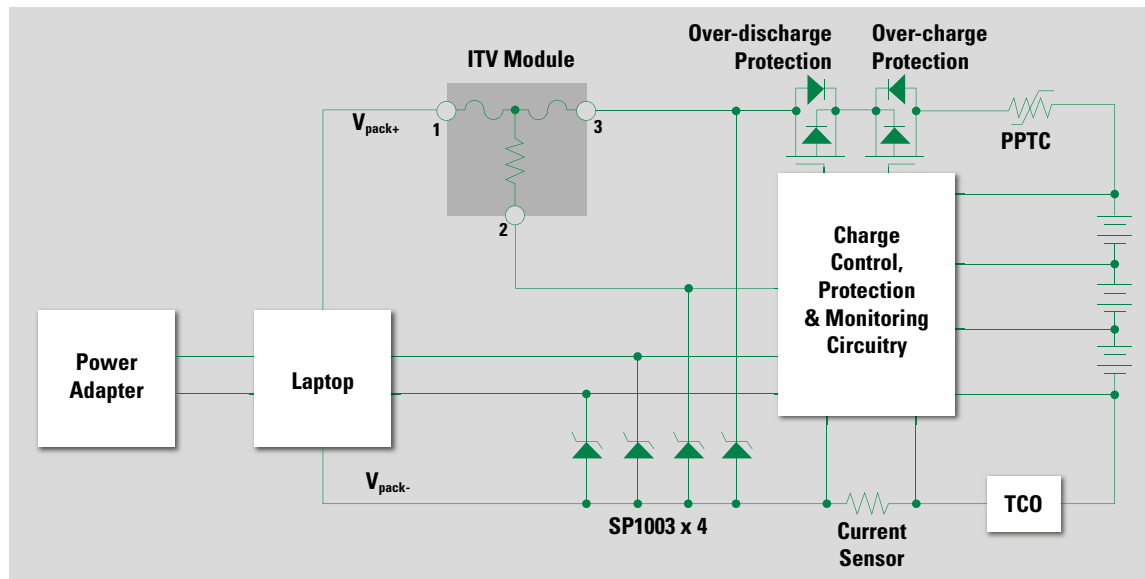

Installation and Handling Guidelines

- Before and after mounted, the ultrasonic-cleaning or immersion-cleaning must not be done to ITV device. The flux on element would flow, and it would not be satisfied its specification when cleaning is done. In addition, a similar influence happens when the product comes in contact with cleaning solution. These products after cleaning will not be guaranteed.
- Silicone-based oils, oils, solvents, gels, electrolytes, fuels, acids, and similar will adversely affect the properties of ITV devices, and shall not be used or applied.
- Please DO NOT reuse the ITV device removed by the soldering process.
- ITV devices are secondary protection devices and are used solely for sporadic, accidental overcurrent or overtemperature error condition, and shall NOT be used if or when constant or repeated fault conditions (such fault conditions may be caused by, among others, incorrect pin-connection of a connector) or over-extensive trip events may occur.
- Operation over the maximum rating or other forms of improper use may cause failure, arcing, flame and/or other damage to the ITV devices.
- The performance of ITV devices will be adversely affected if they are improperly used under electronic, thermal and/or mechanical procedures and/or conditions non-conformant to those recommended by manufacturer.
- Customers shall be responsible for determining whether it is necessary to have back-up, failsafe and/or fool-proof protection to avoid or minimize damage that may result from extra-ordinary, irregular function or failure of ITV devices.
- There should be minimum of 0.1mm spacing between ITV and surrounding compounds, to maintain the product characteristics and avoid damage other surrounding compounds.
- This product is designed and manufactured only for general-use of electronics devices. We do not recommend that it is used for the applications military, medical and so on which may cause direct damages on life, bodies or properties.

ITV4030 12A/15A/22A Series

Surface Mount

Tape and Reel Specifications (mm)

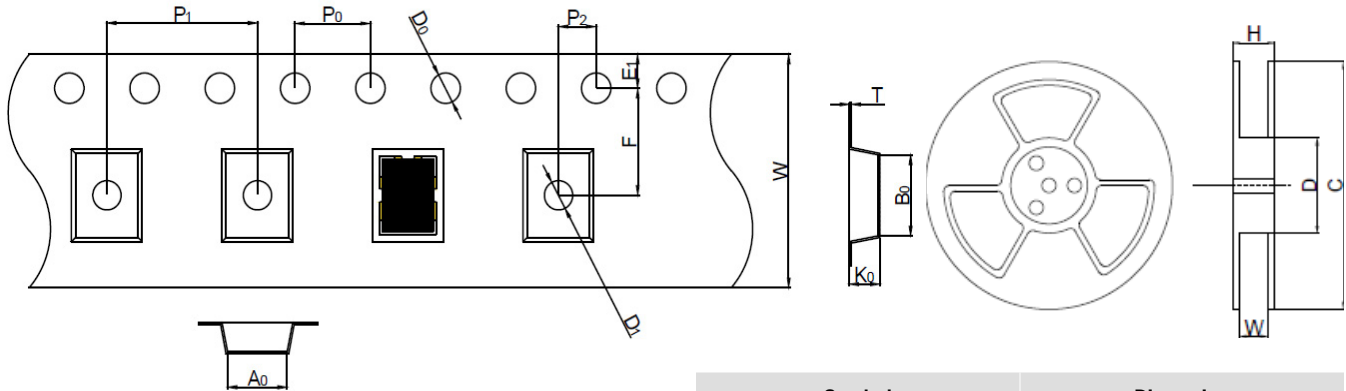

Part Numbering System

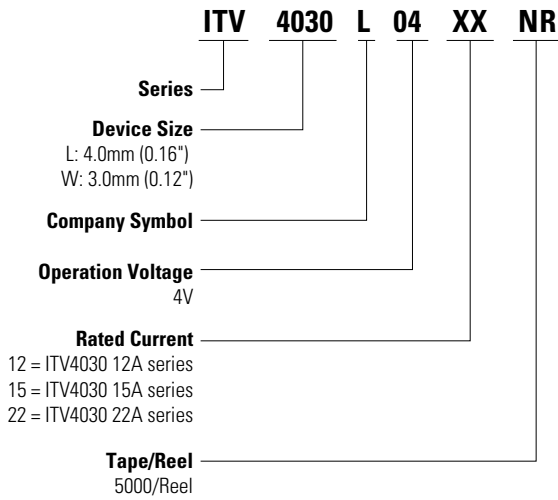

Symbol	Dimension
W	12.0 ± 0.30
F	5.50 ± 0.05
E1	1.75 ± 0.10
D0	1.55 ± 0.05
D1	1.50 ± 0.10
P0	4.00 ± 0.10
P1	8.00 ± 0.10
P2	2.00 ± 0.10
A0	3.32 ± 0.10
B0	4.32 ± 0.10
T	0.23 ± 0.05
K0	1.30 ± 0.10
H	17.4 ± 1.0
W	13.4 ± 1.0
D	Ø99.0 ± 0.5
C	Ø330 ± 1.0

Packaging

Part Number	Tape and Reel Quantity
ITV4030LXXXX	5,000

Part Marking System

Marking System for ITV4030 12A&15A Series

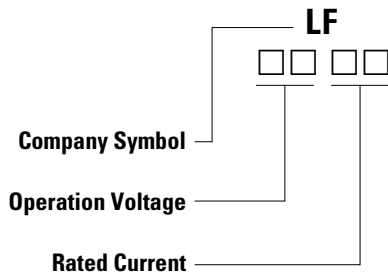

Marking System for ITV4030 22A Series

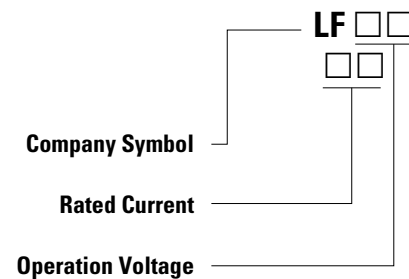

Disclaimer Notice - Information furnished is believed to be accurate and reliable. However, users should independently evaluate the suitability of and test each product selected for their own applications. Littelfuse products are not designed for, and may not be used in, all applications. Read complete Disclaimer Notice at www.littelfuse.com/disclaimer-electronics.