

**PLED Ultra Low Holding Current Series**



**Description**

This PLED ultra-low holding current series exhibits a low holding current parameter that makes it compatible with LED lighting strings. The series provide a switching electronic characteristics for an fluorescent tube replacement by an LED string. It helps to make the Fluorescent ballast and LED string compatible with each other. This ensures the ballast will be able to activate the LED string; especially for those ballast that need a high voltage output detection during ignition. The PLED ultra-low  $I_H$  makes the LED driver widely used in the output of fluorescent tubes a compatible direct replacement for indoor and outdoor LED lighting strings.

**Schematic Symbol**

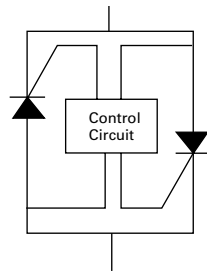

**Features & Benefits**

- Fast switching
- Automatically resets after power cycle
- Available in low profile, Standard DO-214AA packages
- IEC-61000-4-2 ESD 30kV (Air), 30kV (Contact)
- ESD protection of data lines in accordance with IEC 61000-4-2 (IEC 801-2)
- Compatible with industrial lighting environments
- RoHS compliant and halogen-free

**Electrical Characteristics** (All parameters are measured at  $T_A=25^\circ\text{C}$  unless otherwise noted)

Part Number	Marking	$V_{BR}$ Breakdown		$V_{DRM}$	$I_H$	$I_S$	$V_T @ I_T = 1$ Amp	$I_O^1$	Critical rate of rise dV/dt
		Volts		Volts	mAmps	mAmps	Volts	Amps	Volts
		Min	Max	Min	Max	Max	Max	Max	Min
PLED64S	PL64	58	71	56	21	800	2	1.0	250V/ $\mu\text{s}$
PLED70S	PL70	65	81	63	21	800	2	1.0	250V/ $\mu\text{s}$
PLED90S	PL90	75	90	73	21	800	2	1.0	250V/ $\mu\text{s}$
PLED110S	PL110	90	120	87	21	800	2	1.0	250V/ $\mu\text{s}$
PLED130S	PL130	120	149	116	21	800	2	1.0	250V/ $\mu\text{s}$
PLED150S	PL150	136	167	132	21	800	2	1.0	250V/ $\mu\text{s}$
PLED180S	PL180	170	203	165	21	800	2	1.0	250V/ $\mu\text{s}$
PLED230S	PL230	190	240	184	21	800	2	1.0	250V/ $\mu\text{s}$
PLED260S	PL260	220	274	213	21	800	2	1.0	250V/ $\mu\text{s}$
PLED310S	PL310	275	330	267	21	800	2	1.0	250V/ $\mu\text{s}$
PLED350S	PL350	320	380	310	21	800	2	1.0	250V/ $\mu\text{s}$
PLED380S	PL380	350	430	340	21	800	2	1.0	250V/ $\mu\text{s}$
PLED450S <sup>2</sup>	PL450	410	495	397	21	800	2	1.0	250V/ $\mu\text{s}$
PLED480S <sup>2</sup>	PL480	450	600	436	21	800	2	1.0	250V/ $\mu\text{s}$

note:

1.  $I_O$  - Operation current tested @ aluminum boards, ambient temp 85°C
2. PLED450S and PLED480S are still under developed, please contact local sales representative for further information

### Thermal Considerations

Package	Symbol	Parameter	Value	Unit
 DO-214	$T_J$	Operating Junction Temperature Range	-40 to +125	°C
	$T_S$	Storage Temperature Range	-65 to +150	°C
	$R_{\theta JA}$	Thermal Resistance: Junction to Ambient	90 <sup>1</sup> 40 <sup>2</sup>	°C/W

Notes:

- 1) Standard FR-4 PCB with Copper Pads (Recommended Size)
- 2) Aluminum PCB

Thickness: 1.6mm  
 Grade: 1-2 W/mK Thermal Conductivity  
 Trace thickness: 2 oz  
 Insulation layer thickness: 215 um  
 Solder Pad Dimensions: 2.0mm x 2.8mm (Recommended Size)

### V-I Characteristics



### $V_{BR}$ vs. Junction Temperature

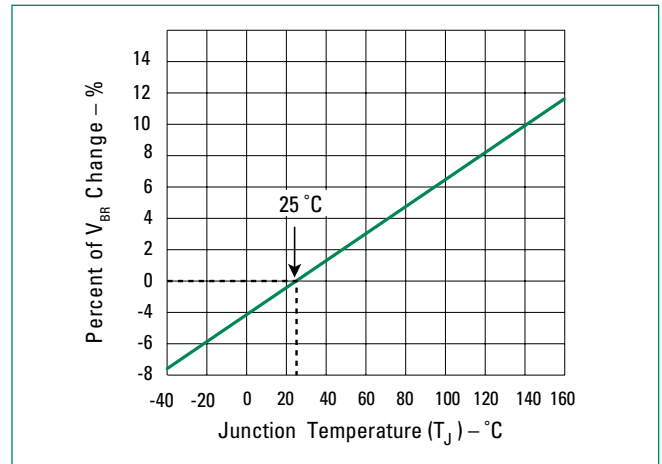

### Normalized DC Holding Current vs. Case Temperature



**Soldering Parameters**

Reflow Condition		Pb – Free assembly
Pre Heat	- Temperature Min ( $T_{s(min)}$ )	150°C
	- Temperature Max ( $T_{s(max)}$ )	200°C
	- Time (min to max) ( $t_s$ )	60 – 180 secs
Average ramp up rate (Liquidus Temp ( $T_L$ ) to peak)		3°C/second max
$T_{s(max)}$ to $T_L$ - Ramp-up Rate		3°C/second max
Reflow	- Temperature ( $T_L$ ) (Liquidus)	217°C
	- Temperature ( $t_L$ )	60 – 150 seconds
Peak Temperature ( $T_p$ )		260 <sup>+0/-5</sup> °C
Time within 5°C of actual peak Temperature ( $t_p$ )		30 seconds
Ramp-down Rate		6°C/second max
Time 25°C to peak Temperature ( $T_p$ )		8 minutes max
Do not exceed		260°C

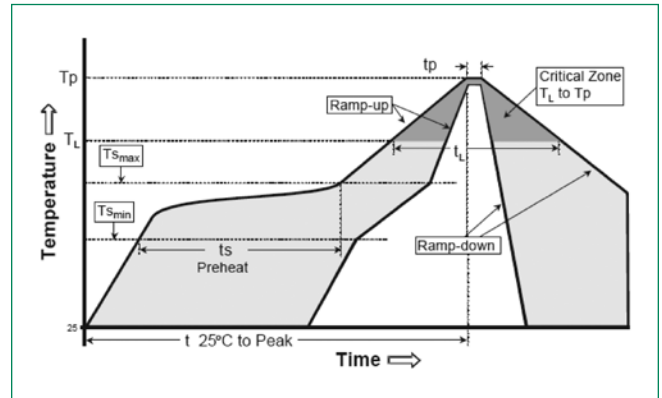

**Physical Specifications**

<b>Terminal Material</b>	Copper Alloy
<b>Terminal Finish</b>	100% Matte Tin Plated
<b>Body Material</b>	UL Recognized compound meeting flammability rating V-0.

**Environmental Specifications**

<b>High Temperature Voltage Blocking</b>	MIL-STD-750: Method 1040, Condition A 80% min $V_{DRM}$ (VAC-peak), 125°C, 1008 hours
<b>Temperature Cycling</b>	MIL-STD-750: Method 1051, -55°C to 150°C, 15-minute dwell, 1000 cycles
<b>Biased Temperature &amp; Humidity</b>	EIA/JEDEC: JESD22-A101 52VDC, 85°C, 85%RH, 1008 hours
<b>Thermal Shock</b>	MIL-STD-750: Method 1056 0°C to 100°C, 5-minute dwell, 10-second transfer, 10 cycles
<b>Resistance to Solder Heat</b>	MIL-STD-750: Method 2031 260°C, 10 seconds
<b>Moisture Sensitivity Level</b>	85%RH, +85°C, 168 hours, 3 reflow cycles (+260°C peak). JEDEC-J-STD-020, Level 1

**Dimensions - DO-214 AA Package**

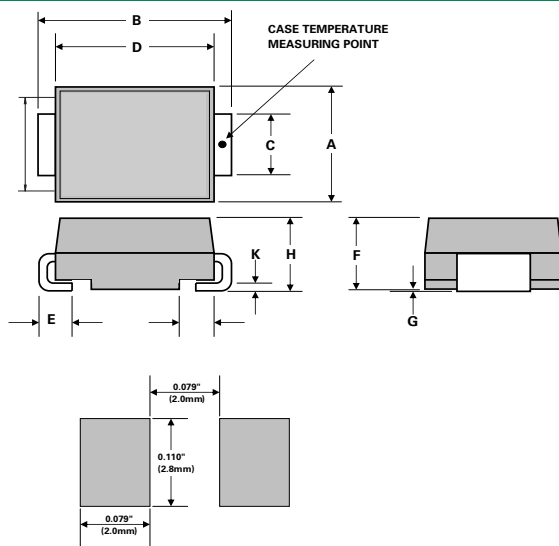

Recommended solder pad layout  
(Reference Only)

Dimensions	Inches		Millimeters	
	Min	Max	Min	Max
A	0.130	0.156	3.30	3.95
B	0.201	0.220	5.10	5.60
C	0.077	0.087	1.95	2.20
D	0.159	0.181	4.05	4.60
E	0.030	0.063	0.75	1.60
F	0.075	0.096	1.90	2.45
G	0.002	0.008	0.05	0.20
H	0.077	0.104	1.95	2.65
K	0.006	0.016	0.15	0.41

**Part Numbering System**

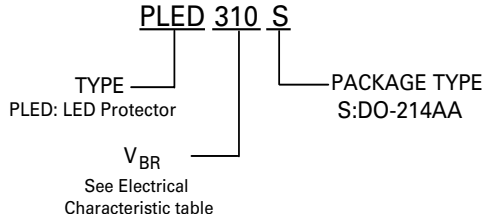

**Part Marking System**

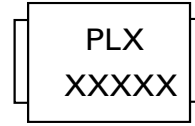

**Packaging**

Package	Description	Packaging Quantity	Industry Standard
S	DO-214AA	2500	EIA-481-1

**DO-214 Embossed Carrier Reel Pack (RP)**

**Meets all EIA-481-1 Standards**

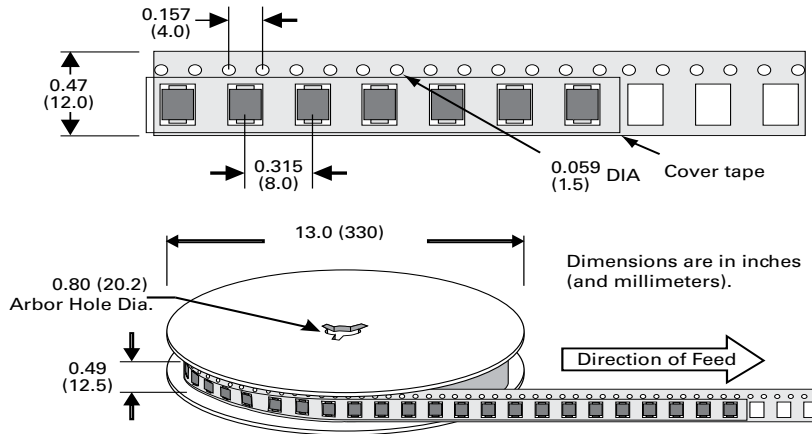

**Disclaimer Notice** - Information furnished is believed to be accurate and reliable. However, users should independently evaluate the suitability of and test each product selected for their own applications. Littelfuse products are not designed for, and may not be used in, all applications. Read complete Disclaimer Notice at <http://www.littelfuse.com/disclaimer-electronics>.