

PLED5 QFN Series

RoHS

OBSOLETE DATE: 31/12/2018 PCN/ECN#_LFPCN41214
REPLACED BY: PLED6N

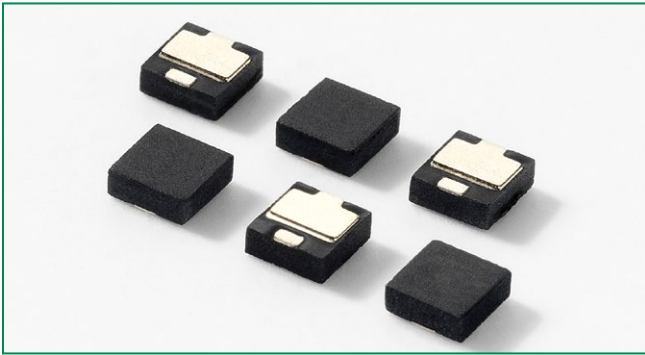

Description

This PLED5 Open LED Protector component provides three methods for increasing the reliability of LED lighting:

- 1) If one of the LEDs in an array fails open, this device provides a substitute electronic path so that the string continues to function
- 2) It protects against ESD events up to ± 8 kV for contact discharges and ± 15 kV for air discharges per the IEC 61000-4-2 electrostatic immunity standard.
- 3) It provides protection in the case of accidental reverse battery or power connection.

Schematic Symbol

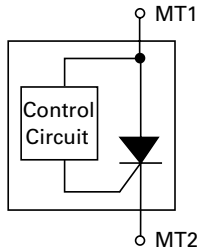

High reliability of lighting functions such as traffic lighting, aircraft lighting, advertising lighting, and runway lighting demand the use of a component such as the PLED5.

Littelfuse offers over current component for implementation in power circuits that can also enhance the reliability of circuit operation. Our full line of circuit protection products can be viewed at www.littelfuse.com.

Pinout

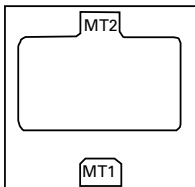

Features & Benefits

- Reverse Battery/Power Protection
- Low Turn-On (Trigger Voltage)
- ESD, IEC 61000-4-2, ± 8 kV contact, ± 15 kV air
- Ideal for MR16, PAR type lamps
- Open LED bypass up to 500 mA
- Fast Switching
- Resets After Power Cycle

Electrical Characteristics

Part	Marking	Symbol	Parameter	Conditions	MIN	TYP	MAX	Unit	
PLED5Q12	Px5	V_{AK}	Input Voltage				40	V	
		V_{TO}	Turn-On Voltage		4.65	4.9	5.15	V	
		I_S	Switching Current				20	mA	
		V_{OS}	On-State Voltage	$I_{AK} = 350$ mA			1	1.3	V
		I_{OS}	On-State Current	(with adequate heat sinking)				500	mA
		V_{OSR}	Reverse On-State Voltage	$I = 350$ mA			1	1.4	V
		I_{OSR}	Reverse On-State Current					500	mA
		I_{DRM}	Leakage Current	$V_{AK} = 3.5$ V			100	150	μ A
		V_{ESD}	ESD Withstand Voltage ¹	IEC 61000-4-2 (Contact)		± 8			kV
		IEC 61000-4-2 (Air)		± 15			kV		

Notes:
¹Parameter is guaranteed by design and/or component characterization.

Thermal Considerations

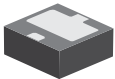
Package	Symbol	Parameter	Value	Unit
 QFN	T_{OP}	Operating Temperature	-40 to 85	°C
	T_J	Maximum Junction Temperature	150	°C
	T_{STOR}	Storage Temperature	-65 to 150	°C

V-I Characteristics

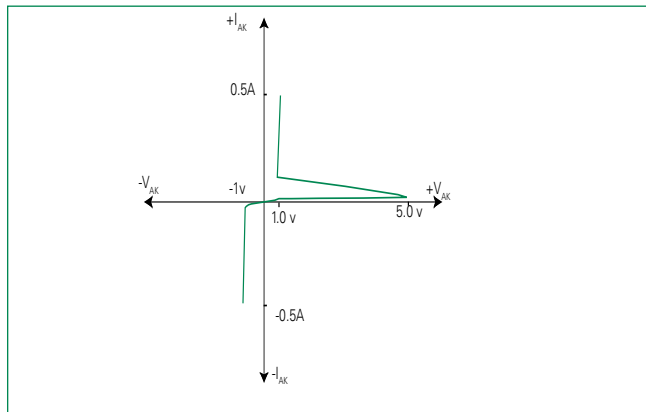

Switching Current vs Temperature

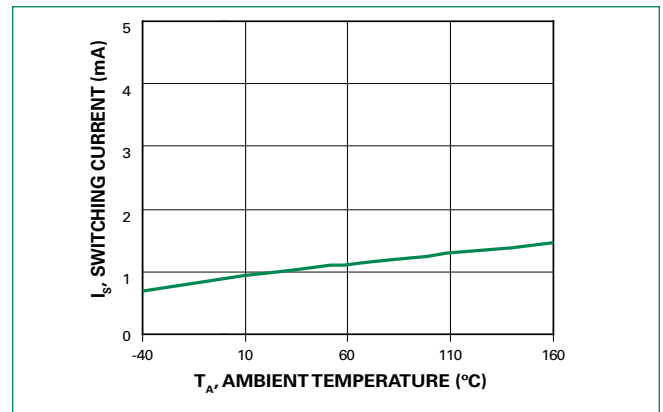

Turn On Voltage vs Temperature

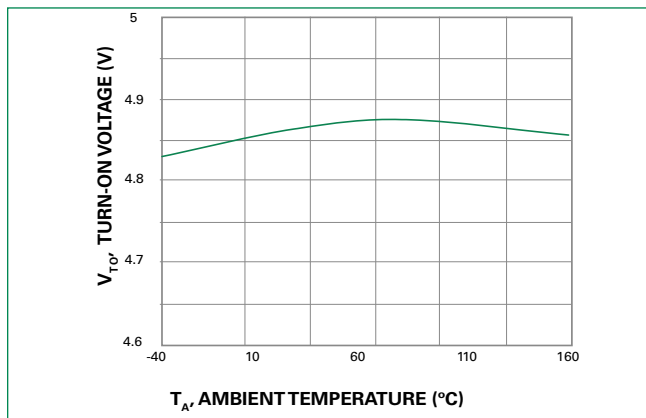

Leakage Current vs Temperature

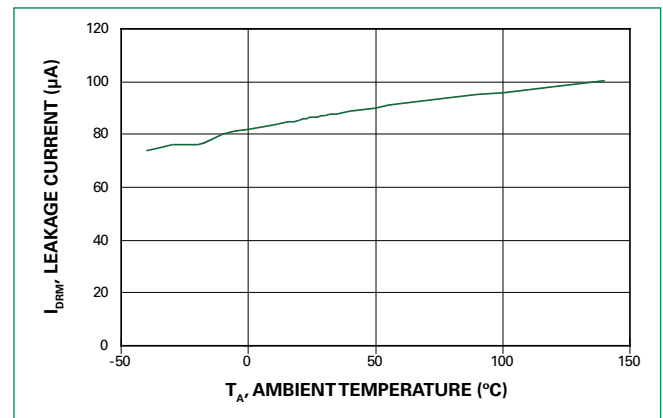

LED Application and Interference Test Circuit

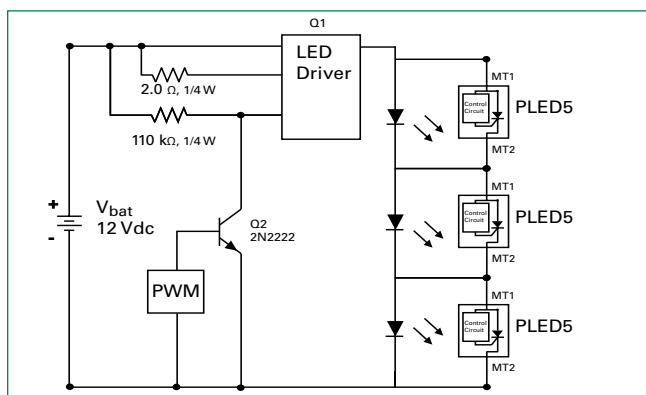

Ordering Information

Catalog Number	Package Type	Quantity Per Reel
PLED5Q12	QFN	3000 Pieces

Part Numbering System

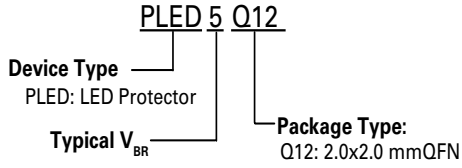

Part Marking System

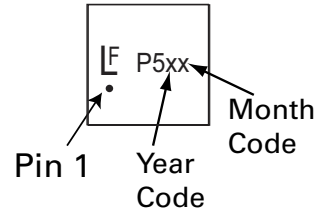

Package Dimensions - QFN

Device Dimensions:

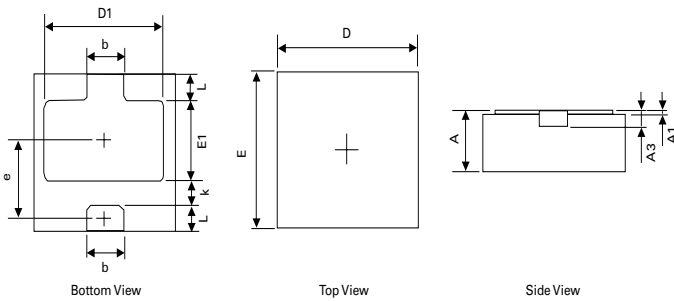

Recommended Soldering Pad Dimensions:

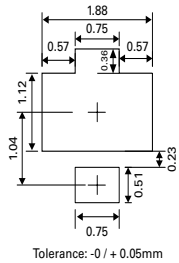

Dimension Symbol	Millimetres	
	Min	Max
A	0.700/0.800	0.800/0.900
A1	0.000	0.050
A3	0.203REF	
D	1.924	2.076
E	1.924	2.076
D1	1.580	1.780
E1	0.820	1.020
k	0.200MIN.	
b	0.550	0.650
e	1.045TYP.	
L	0.254	0.406

Tape and Reel Specification - QFN

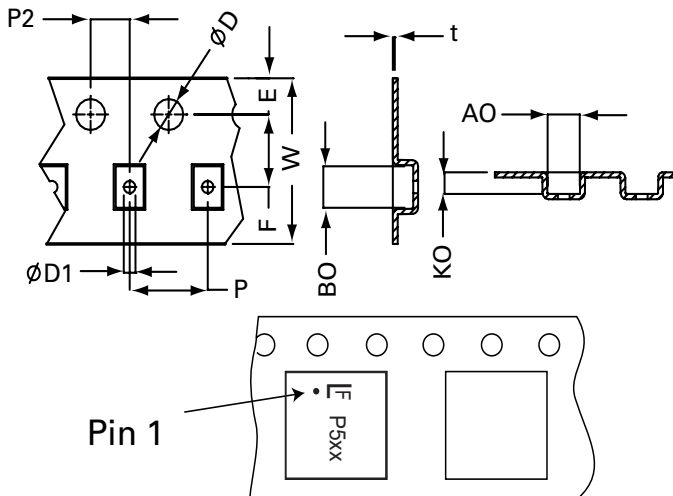

	Millimetres		Inches	
	Min	Max	Min	Max
E	1.65	1.85	0.065	0.073
F	3.45	3.55	0.136	0.140
D1	1.00	-	0.040	-
D	1.50 min		0.059 min	
P	3.90	4.10	0.154	0.161
W	7.70	8.30	0.303	0.327
P2	1.95	2.05	0.077	0.081
A0	2.20	2.30	0.086	0.090
B0	2.20	2.30	0.086	0.090
K0	0.64	0.74	0.025	0.029
t	0.20 typ		0.007 typ	