

Application note for the use of the IGBT T2960BB45E in a DC-breaker application

1 Introduction

DC-breaker is an emerging type of electrical equipment that is capable of turning off very large DC fault currents in a few milliseconds. High voltage (HV) DC-breakers are normally used for HVDC transmission systems, and medium voltage (MV) DC-breakers are usually used for MV DC distribution systems, including DC networks for marine and urban metro systems. There are various designs for DC-breakers, many of them are based on power electronic switches typically IGBTs. The characteristics of IGBTs are generally well understood for converter applications, however an IGBT will be used in a different way in a DC-breaker. For instance, in a DC-breaker, IGBTs are usually required to turn off DC fault currents far beyond their SOA, which is confusing for even seasoned converter designers. Thus, in order to make efficient use of the press-pack IGBT (PP-IGBT) T2960BB45E in a DC-breaker, it is necessary to discuss special requirements and the proper setup for IGBTs in such an application.

2 Basic theory of DC-breakers

Although there are a variety of design schemes for DC-breakers, the general structure of a DC-breaker can be divided into three branches, namely normal operating branch, commutation branch and energy absorption branch (Fig. 1). As indicated by its name, the normal operating branch is used for conduction of normal load current, and typically it has very low impedance so there are minimum conduction losses. One simple example for the normal operating branch is a mechanical breaker with metallic conductors, although more complex designs may be used.

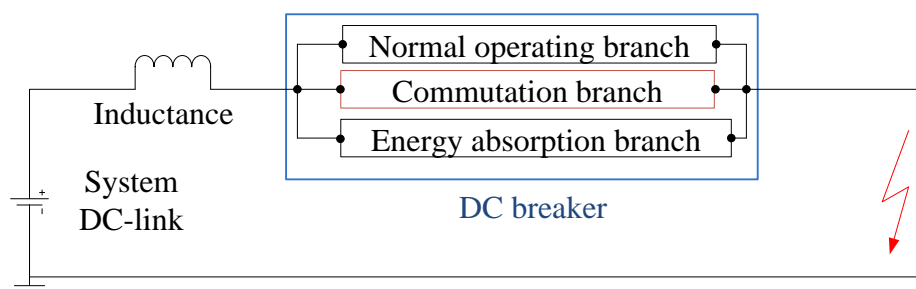

Fig. 1. General structure of DC-breakers

On the other hand, the commutation branch and energy absorption branch work together to tackle DC fault current, that is, DC short circuit current. The energy absorption branch is made of metal-oxide varistor (MOV) surge arrester, in which the stored energy due to inductances and DC fault current in the circuit will be finally dissipated.

The commutation branch is the transition between the normal operating branch and the energy absorption branch. When the short circuit fault is detected, that is the load current exceeding a

certain pre-defined threshold (e.g.120%), the commutation branch will be turned on. This will serve as a low impedance alternative current route to the normal operating branch. In this way, the initial fault current in the normal operating branch can be interrupted and commutated into the commutation branch relatively easily. As the next step, the fault current will usually continue to increase when conducting through the commutation branch, at least until the normal operating branch is completely able to block the system DC voltage. This stage normally won't last more than 2ms, however, many DC-breaker specifications do require that the commutation branch shall have certain fault current withstanding capabilities, for instance 10kA for 5ms. With such capabilities, if the fault situation is spurious or disappears quickly, the load current can still be commutated back to the normal operating branch, without interrupting the transmission/distribution line. Moreover, as the last step of DC-breaker operation, the commutation branch needs to turn off the fully developed DC short-circuit current (e.g. up to 40kA), and the occurring turn-off overvoltage across the DC-breaker terminals will drive the surge arrester into the low-ohmic operating status. As a result, the fault current will be commutated into surge arrester and eventually dissipate as heat.

3 PP-IGBT based commutation branch for DC-breakers

The commutation branch of a DC-breaker is typically made of power semiconductor switches, among which PP-IGBT is almost the only choice due to a few reasons. First of all, for a power semiconductor based commutation branch, usually series connection of certain amount of power devices is needed, in order to block the system DC voltage. The feature of short-circuit-failure-mode(SCFM) of PP-IGBT is essential for series connection of power devices, because failure of individual device won't interrupt the operation of the whole structure, as long as a certain number of redundant ones are included. In the second place, the sheer high current rating of PP-IGBT is attractive for this application, given that nowadays DC-breaker is usually designed to turn off fault currents from 10kA to 40kA. Moreover, the unique internal structure of PP-IGBT allows it to have high surge current capabilities, which is useful to meet requirements of fault current withstanding capabilities of DC-breakers.

4 A case study of the use of the PP-IGBT T2960BB45E in a DC-breaker application

In this case study, the PP-IGBT T2960BB45E(4.5kV/3kA) will be used in the commutation branch of a DC-breaker, which is a composite switch with a number of series connected PP-IGBT, ranging from a few pieces to hundreds of pieces per system requirements. For instance, for a 10kV MV DC distribution system, five pieces of 4.5kV PP-IGBT in series will be enough to block the system DC voltage when needed; but for a 200kV HVDC transmission system, around one hundred pieces of 4.5kV PP-IGBT in series will be needed. As mentioned above, the unique feature of SCFM of the PP-IGBT T2960BB45E, will guarantee continuous operation of a composite switch, should individual ones fail.

Besides SCFM, there are two other essential requirements for PP-IGBT in this application, they are, withstanding very high fault currents for milliseconds (e.g. up to 10ms) and then turning off the fault currents safely. In this study, the target is to withstand **15kA** for **5ms** and then turn off the fault current, by using a single PP-IGBT T2960BB45E.

From normal converter design experience, this target **15kA** for **5ms** may seem unrealistic for an IGBT for two reasons. First of all, 15kA is five times the nominal current of T2960BB45E, and much higher than its short circuit current I_{SC} (10.9kA) in the datasheet. Usually IGBT manufacturers only guarantee $10\mu s$ short circuit current I_{SC} , which is much shorter than 5ms. Moreover, 15kA is beyond the SOA of T2960BB45E (6kA) that it may not be turned off safely.

However, there are essential differences between a converter application and a DC-breaker application. When used in converters, IGBTs need to be switched hundreds or even thousands of times per second. On the other hand, usually IGBTs in DC-breakers are expected to switch off hundreds of times in their whole lifecycle (e.g. 30 years). It means special setup is allowed for IGBTs when used in DC-breakers, such as elevated gate voltage, large snubber circuit and a relatively low DC-link voltage for the single level of IGBT.

4.1 Current withstanding capabilities

In order to guarantee that the PP-IGBT T2960BB45E is able to withstand 15kA for 5ms, the key is to raise gate voltage, so as to prevent T2960BB45E from desaturation. In this way, the on-state voltage drop $V_{CE(sat)}$ of T2960BB45E will be kept at quite a low value even when conducting 15kA. This can be illustrated by the output characteristics of T2960BB45E (Fig. 2&3), with different gate voltages as variables. In this study, the gate drive voltage is set to 20V, at which the on-state voltage drop of T2960BB45E @15kA@125°C is around 8.2V without desaturation (Fig. 3).

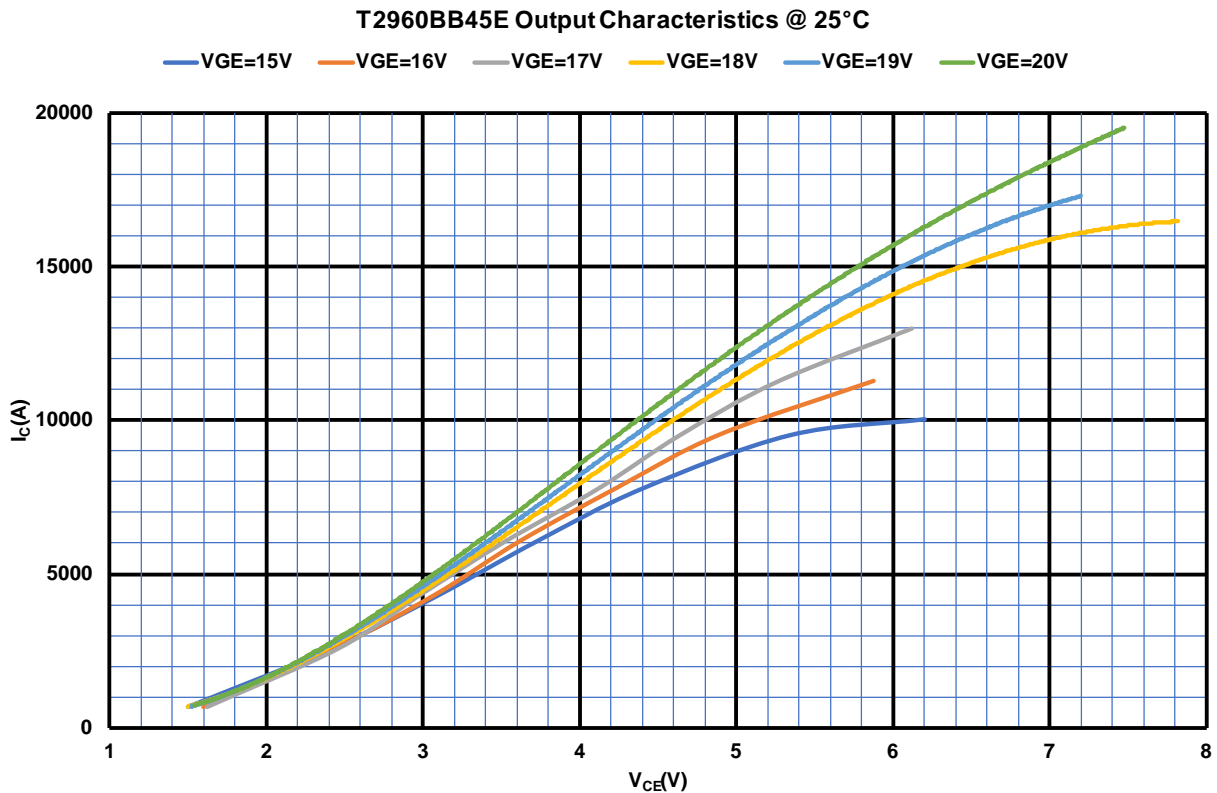

Fig. 2. Output characteristics of T2960BB45E @25°C

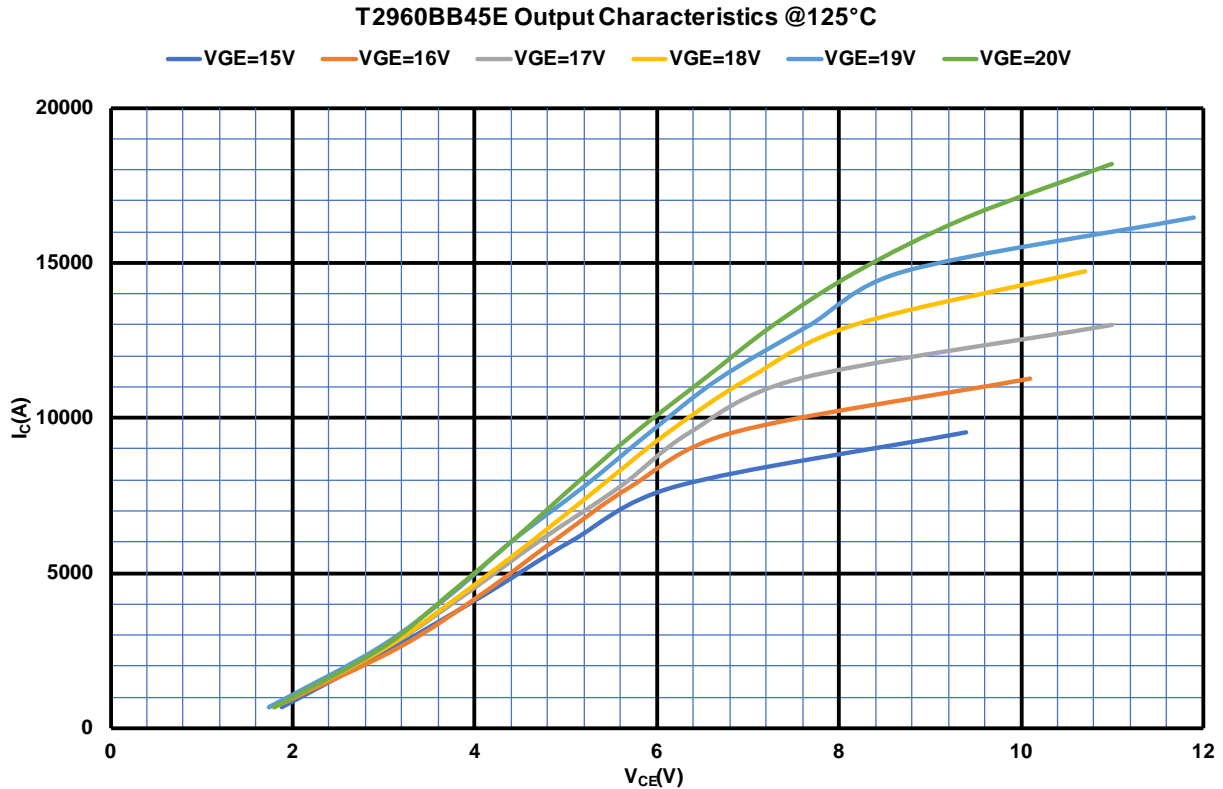

Fig. 3. Output characteristics of T2960BB45E @125°C

4.1.1 Case 1 - manual calculation of junction temperature rise ΔT

In this example of manual calculation, the collector current is assumed to be 15kA constant for 5ms. As the first step, a conservative value of power dissipation can be calculated simply by multiplying collector current by on-state voltage drop of T2960BB45E @15kA @125°C as follows,

$$P = 15\text{kA} \times 8.2\text{V} = 123\text{kW} \quad (1)$$

The junction temperature rise ΔT of T2960BB45E during this 5ms can then be derived by multiplying power dissipation by its transient thermal impedance at 5ms. This value can be read as 0.00071K/W in the transient thermal impedance curve (TTIC) of T2960BB45E in its datasheet, which is shown in Fig. 4 here. As a result, the junction temperature rise ΔT can be calculated as

$$\Delta T = 123\text{kW} \times 0.00071\text{K/W} = 87^\circ\text{C} \quad (2)$$

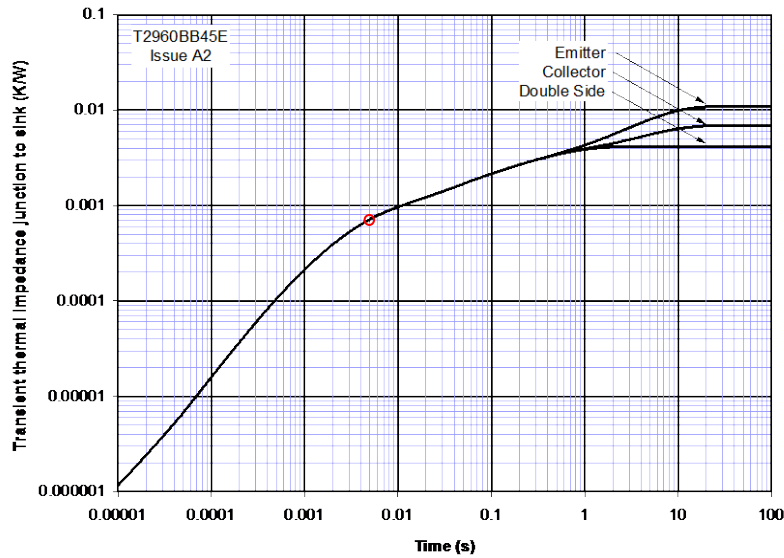

Fig. 4. Transient thermal impedance curve of T2960BB45E

4.1.2 Case 2 - simulation of junction temperature

In this example, the following current and voltage waveforms of T2960BB45E are assumed (Fig. 5a), for a 10kV DC distribution network with 2.4mH stray inductance in the loop. When the IGBT is turned off after 5ms, the collector current is assumed to be commutated into the snubber circuit within 2μs, during which the collector-emitter voltage rises to 2kV. The reason for this assumption will be explained in the next subsection. In addition, before 5ms, the on-state voltage drops of T2960BB45E are obtained from its output characteristic curve @20V @125°C (Fig. 3), which shall be conservative enough for power dissipation calculation. The junction temperature calculation results are shown in Fig. 5b, where the final junction temperature will reach 122°C (ambient 40°C) this is within operating temperature range of the T2960BB45E.

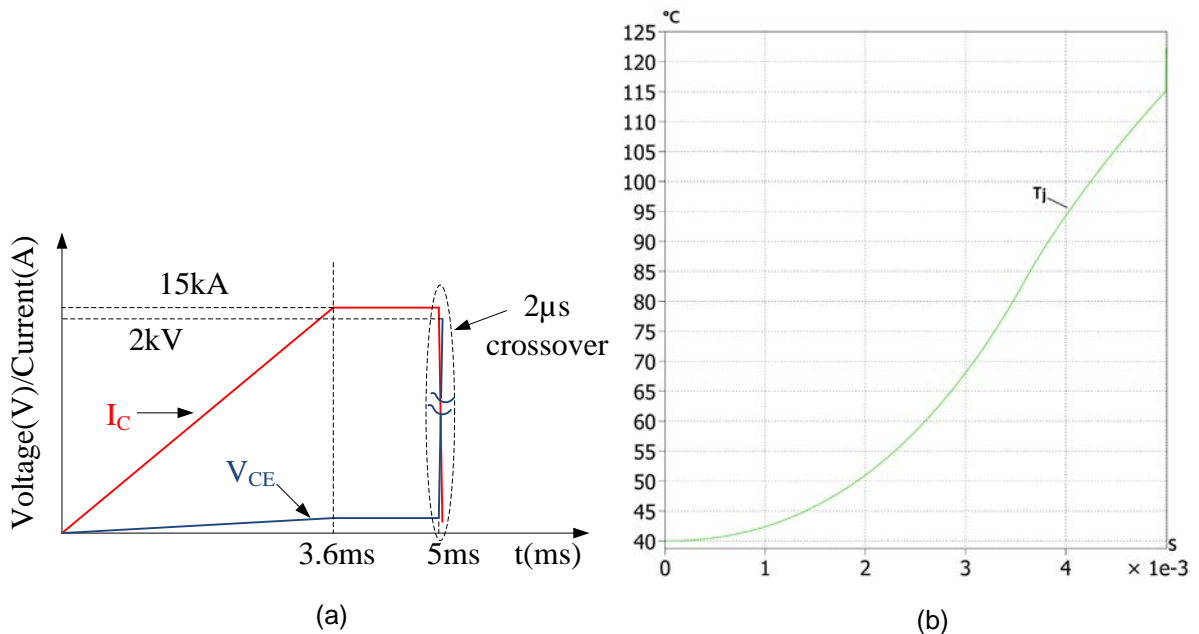

Fig. 5. (a) Current and voltage waveforms of PP-IGBT in a DC-breaker during a short circuit scenario; (b) Simulation results of PP-IGBT junction temperature

4.2 Turning off very high current capabilities

4.2.1 Key measures for PP-IGBT to turn off very high current

To make sure that T2960BB45E is able to turn off very high current such as 15kA, there are a few measures that need to be taken. First of all, the DC-link voltage for each level of IGBT in a series connection arrangement shall be lower than a normal value in converter applications. Experiments show that current turning-off capabilities of IGBTs will increase with decreasing DC-link voltage, and 2~2.2kV can be a good range of DC-link voltage for T2960BB45E for DC-breaker applications.

Moreover, RCD snubber circuit shall be used for the IGBT (Fig. 6) to assist turn-off. Selection of capacitance value of the snubber circuit is critical, because it will determine the turn-off dv/dt of the IGBT, once the IGBT current is commutated into the snubber circuit taking less than $2\mu s$. A good reference value for turn-off dv/dt of an IGBT is around $300V/\mu s$, and such a slow dv/dt is very important for a few reasons. Firstly, good dynamic voltage sharing for a large number of IGBTs in series connection is usually a very difficult technical issue, and a slow turn-off dv/dt will greatly alleviate this issue. Secondly, a slow turn-off dv/dt can effectively avoid turn-off overvoltage across the IGBT, because it will give the MOV surge arrester more time to respond. In addition, a slow turn-off dv/dt will greatly prolong the IGBT tail current stage, which may smooth out the thermal impact during the tail current stage of IGBT.

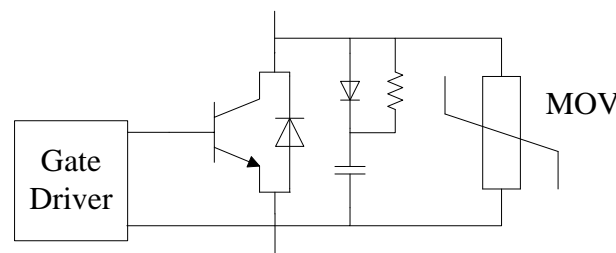

Fig. 6. RCD snubber and MOV arrangement

Another important design consideration is the MOV surge arrester, which typically has slower response than snubber circuit. In fact, when DC-breaker is turned off, usually IGBT shows higher overvoltage than snubber circuit, which in turn shows higher overvoltage than surge arrester. Furthermore, normally a specific 'clamping voltage' is defined in MOV specification, in real operation this 'clamping voltage' will vary depending on load conditions. Therefore, design coordination among IGBT, snubber circuit and surge arrester is necessary, most likely through trial and error method, in order to guarantee IGBT turn-off overvoltage is within specification (e.g. 3.3kV average with 10% tolerance for T2960BB45E in series connection).

4.2.2 Lab demonstration I using the PP-IGBT T0160NB45A

To demonstrate the concept design for the DC-breaker application using PP-IGBT, a miniature DC-breaker test-rig using the PP-IGBT T0160NB45A has been built in the lab (Fig. 7~8). The PP-IGBT T0160NB45A has a nominal current rating of 160A, SOA rating of 320A and short circuit rating of 550A. In the snubber circuit, the capacitance value is $2.5\mu F$; and for the MOV surge arrester, the clamping voltage is around 1250V.

After the DC-link capacitor is fully charged, the power supply will be disconnected from the circuit and then the IGBT will be triggered with 20V gating voltage. After about 1ms, the collector current will reach peak value, and then the IGBT will be turned off with -15V gate voltage.

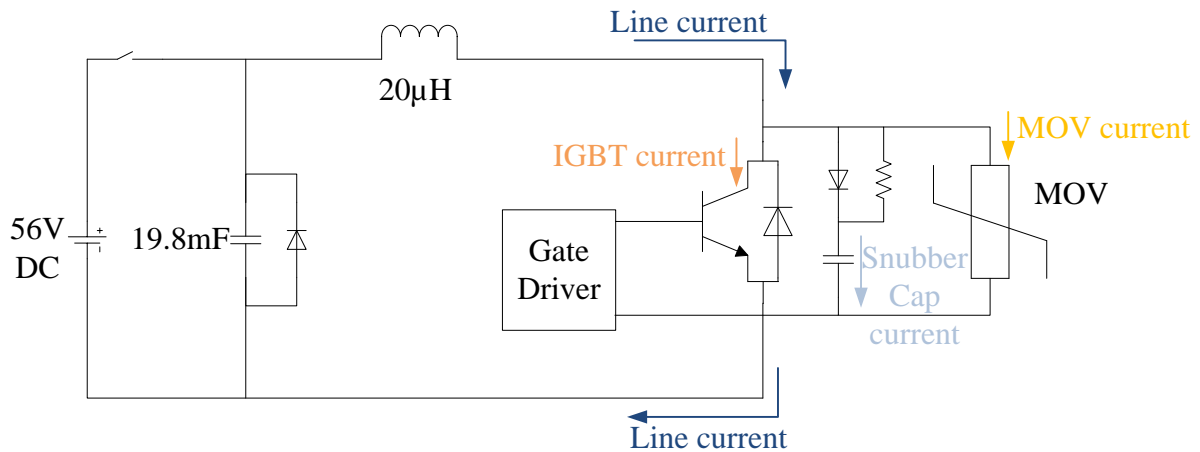

Fig. 7. Lab testing circuit I

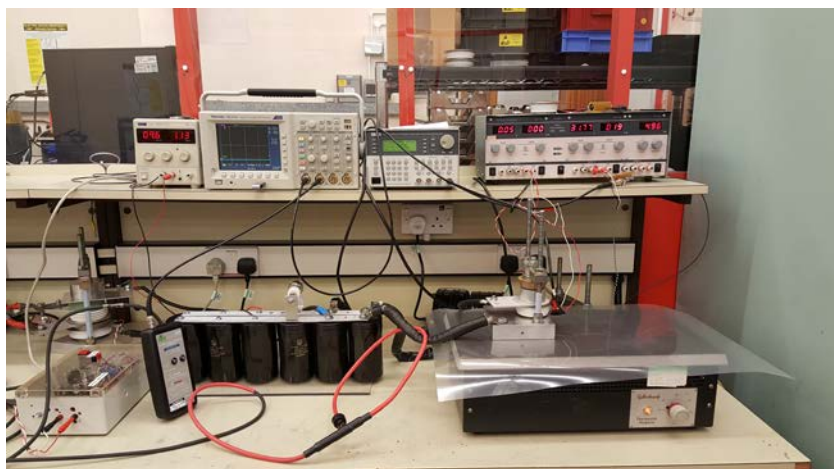

Fig. 8. Lab testing setup

As shown in Fig. 9, the miniature DC-breaker using T0160NB45A successfully turns off about 960A, which is 6 times the nominal current of T0160NB45A. This validates the effectiveness of the design concept with a miniature DC-breaker based on PP-IGBT T0160NB45A. With proper scaling of this design, there are good reasons to believe that DC-breakers based on PP-IGBT T2960BB45E can turn off 15kA DC short-circuit fault current.

In Fig. 9, as the first step of the turning off process, after switching gate voltage from +20V to -15V on IGBT, majority of the IGBT current (the orange curve) is commutated into snubber circuit (the gray curve) swiftly. For the next step, the snubber current is commutated into the MOV surge arrester (the yellow curve). This current transfer is triggered, because the snubber capacitor is continuously charged by the DC short-circuit fault current, and eventually its voltage will exceed the MOV clamping voltage, which will turn the MOV into low impedance status for current to flow. The current peaks of both snubber and MOV current come from the snubber diode reverse recovery current. In the last stage, the MOV current gradually decreases to zero and dissipates as heat inside the MOV. The blue curve is the total line current across the two terminals of this miniature DC-breaker, and it shall be equal to the sum of all parallel branch currents of this miniature DC-breaker.

In Fig. 10, the orange curve is the IGBT voltage across its collector and emitter (V_{CE}), which shows a turn-off dv/dt of around $304V/\mu s$. There is a small voltage spike at around $-1.5\mu s$ when current commutates from IGBT into the snubber circuit, this is due to stray inductance in the IGBT/Snubber circuit commutation loop as well as V_{FR} of the snubber diode. One phenomenon to pay attention to is, the IGBT shows quite prolonged tail current (around $10\mu s$), because of

such a slow turn-off dv/dt . During this stage, the IGBT voltage V_{CE} can rise up to peak voltage, thus considerable power dissipation can still be generated inside the IGBT, which can potentially cause thermal runaway to IGBTs. In addition, the yellow curve in Fig. 10 is the MOV current, it starts to rise up when the IGBT V_{CE} increases to relatively high voltage that drives MOV into low impedance status.

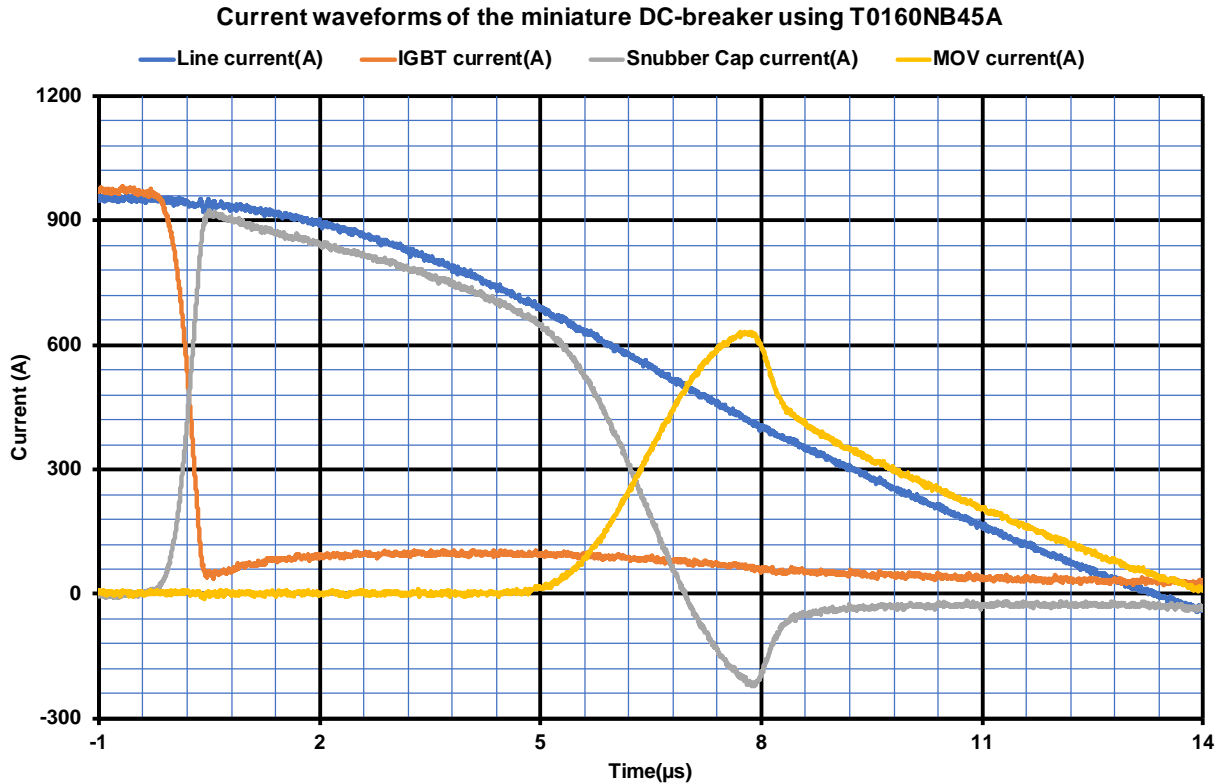

Fig. 9. Current commutation waveforms

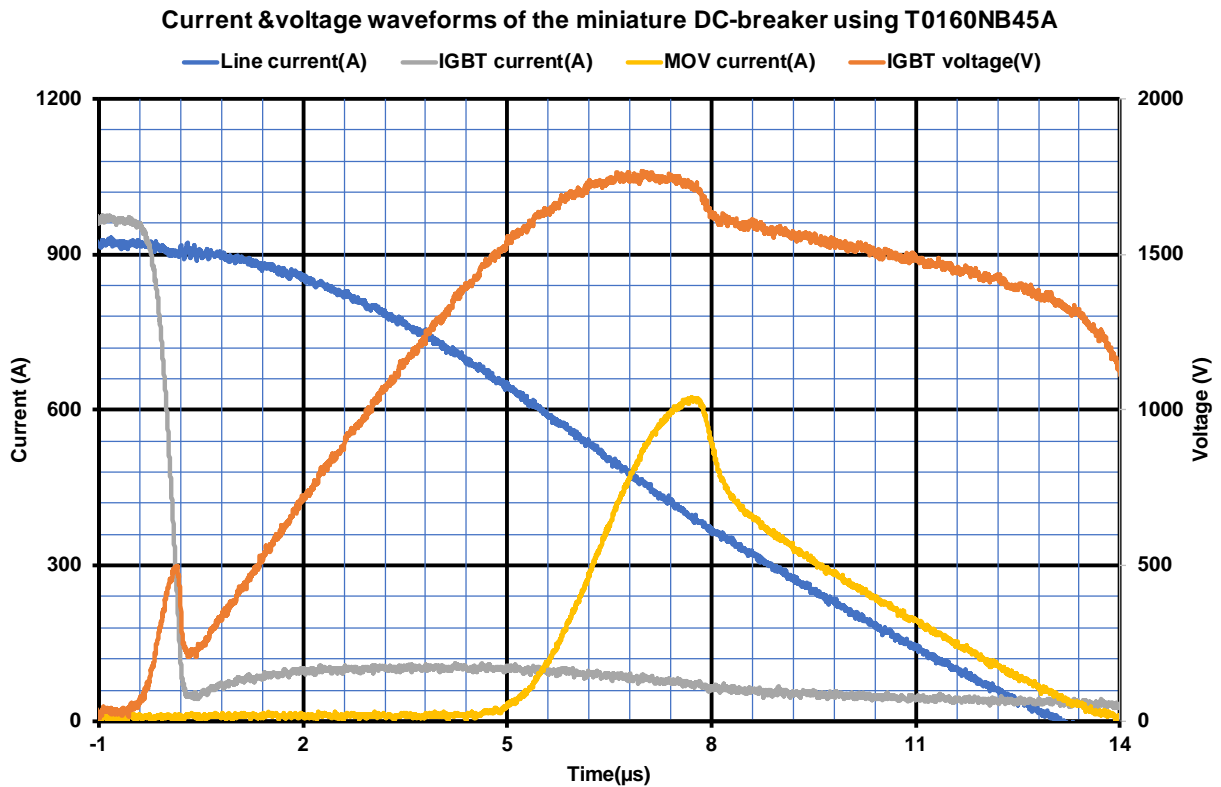

Fig. 10. Current and voltage waveforms of PP-IGBT and MOV

4.2.3 Lab demonstration II using the PP-IGBT T0160NB45A

Fig. 11 shows circuit setup of another lab demonstration using the PP-IGBT T0160NB45A, the purpose of which is to indirectly support the conclusion that the PP-IGBT T2960BB45E is able to withstand 15kA (5 times of its nominal current) for 5ms and then safely turn it off. In this test, the fault current will go through the PP-IGBT for more than 7ms with a peak value of over 960A, before it is turned off. In this way, the total i^2t during the 7ms will be slightly higher than that of a 5ms square current waveform with an amplitude of 5 times of its nominal current. In addition, a new MOV with clamping voltage of 2.97kV will be used, so that the turn-off overvoltage across the PP-IGBT will be more than 3kV. With such a setup, this demonstration shall be able to evaluate high current withstanding and turn-off capabilities of the PP-IGBT at the same time, this is closer to a real DC-breaker application.

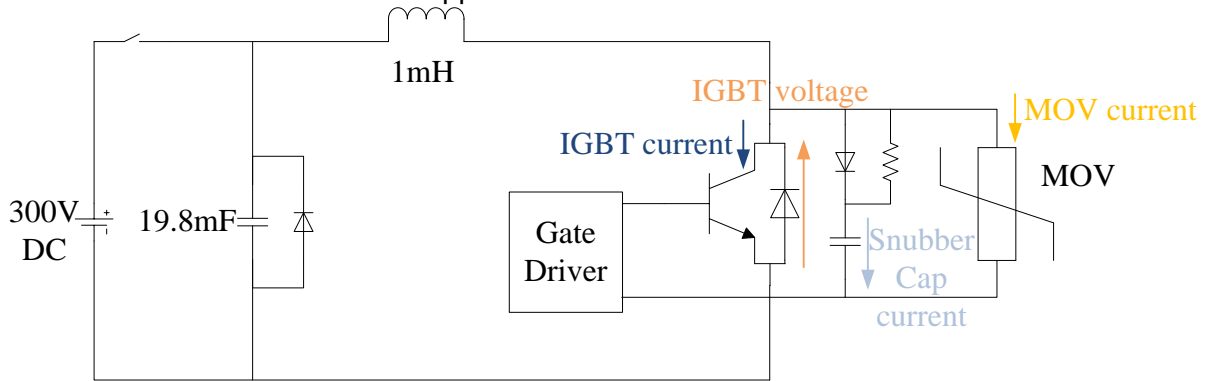

Fig. 11. Lab testing circuit II

In Fig. 12, the blue curve is the IGBT collector current, which lasts over 7ms before it reaches its peak value that is slightly higher than 960A. Then it is safely turned off by being supplied -15V gate voltage, and the collector current is commutated into the snubber circuit (the gray curve) and then into the MOV (the yellow curve).

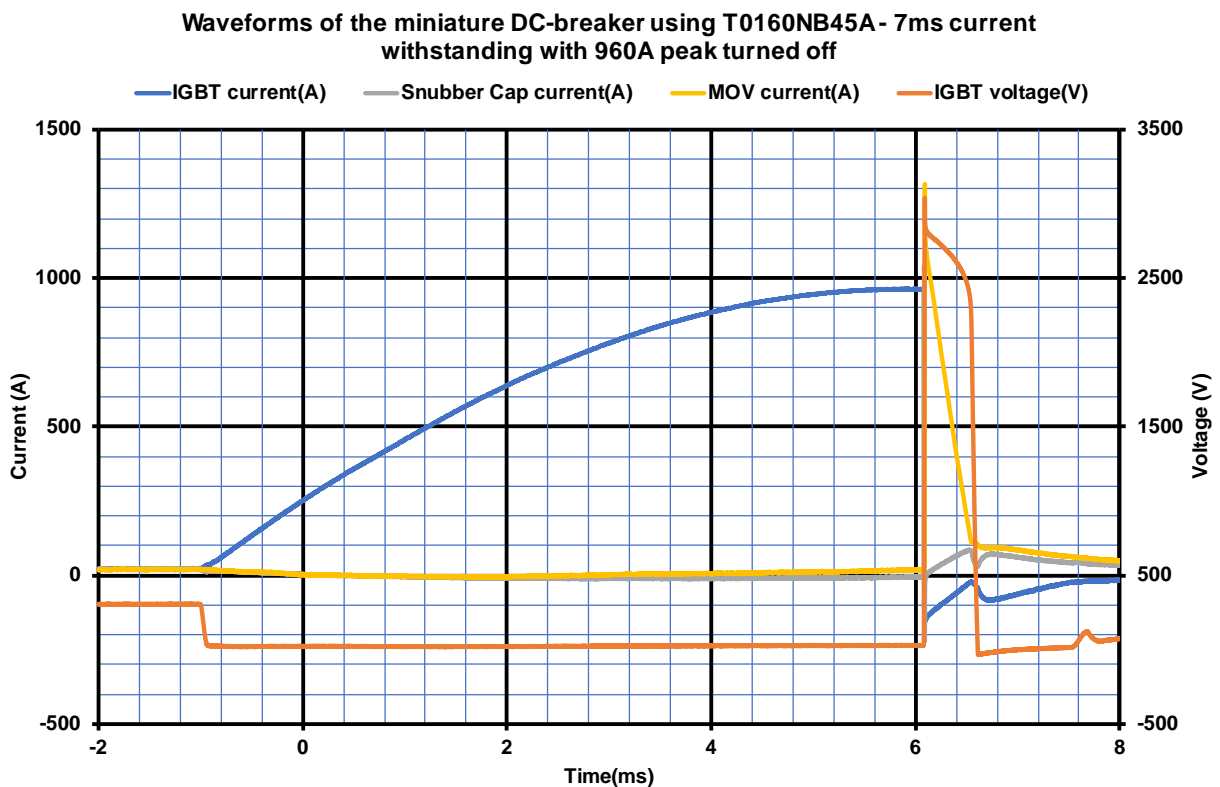

Fig. 12. Waveforms of the miniature DC-breaker - 7ms current withstanding with 960A peak turned off

The detailed current commutation process is shown in Fig. 13. The orange curve in Fig. 12 & 13 is the voltage across the IGBT, and its peak value is 3.04kV in this test, which is well within the safety zone. This test successfully demonstrates strong current withstanding and turning-off capabilities of the PP-IGBT T0160NB45A. By proper scaling-up, it is believed that, the PP-IGBT T2960BB45A is able to withstand 15kA for 5ms and then turn off safely.

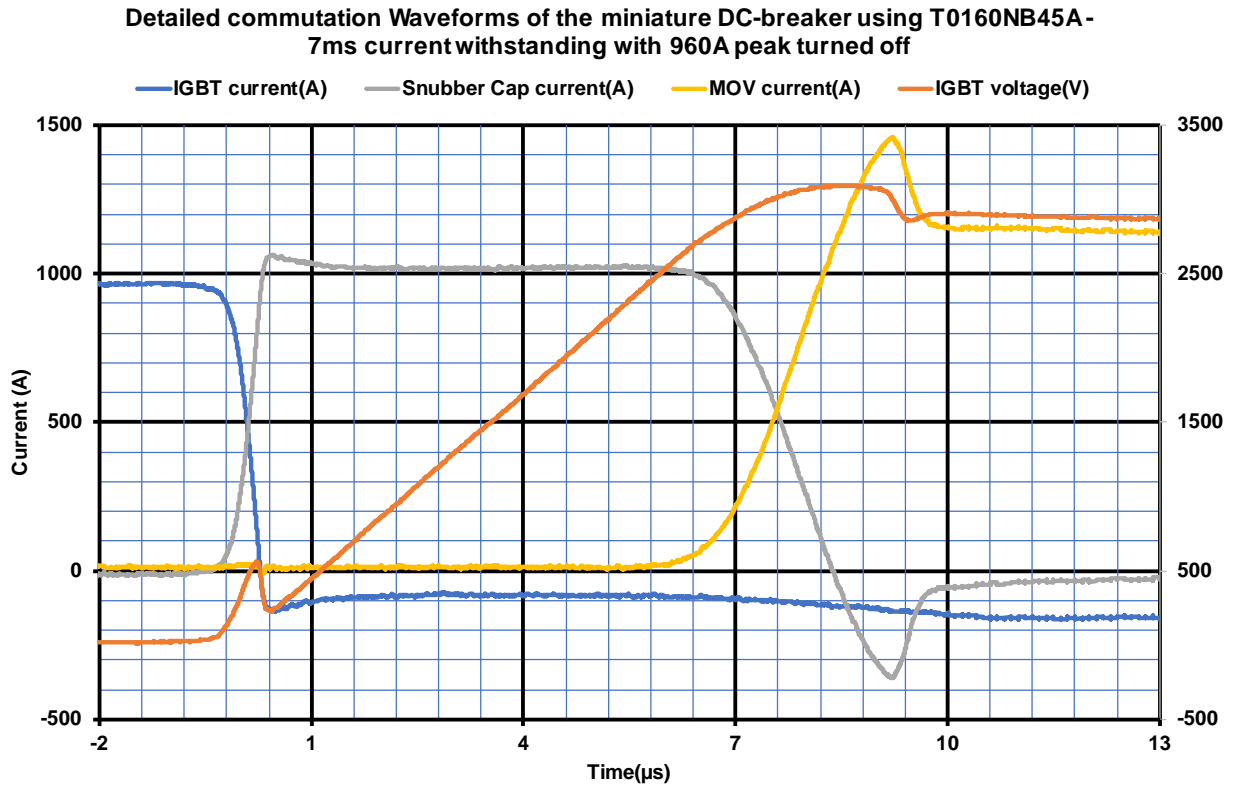

Fig. 13. Detailed commutation waveforms of the miniature DC-breaker

4.2.4 Third-party testing result using the PP-IGBT T2960BB45E

Fig. 14 shows testing results from a third party using the PP-IGBT T2960BB45E for DC-breaker application. In this test, the PP-IGBT turned off 19kA successfully, and its turn-off overvoltage is less than 3.6kV. It proves that the PP-IGBT T2960BB45E is able to switch off very high DC current and is a very competitive device for DC-breaker applications.

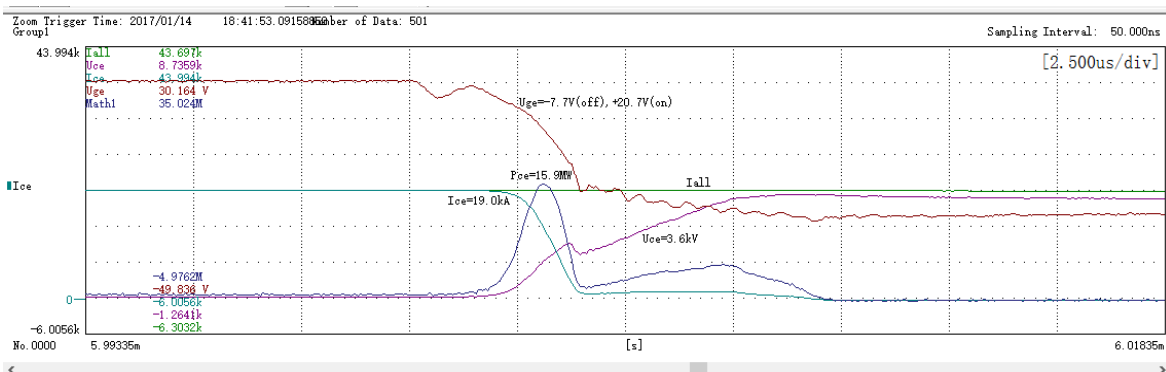

Fig. 14. Third-party testing results using the PP-IGBT T2960BB45E

5 Discussion

Series connection of a large number of IGBTs is a well-known challenging technical topic, besides snubber designs, other factors shall be considered. First of all, banding of IGBT in itself is important, for example, selection of IGBTs from same manufacturing lot, banding on turn-on delay time and so on. Moreover, gate drivers play an important role as well, such as identical propagation delays of gate driver boards, consistent power supply voltage and so on. Last but not least, symmetrical structural layout of the system is another important issue.

It's worthwhile to discuss and compare the role of stray inductance in both converter and DC-breaker applications. For a hard-switching snubber-less converter, the stray inductance in the commutation loop is typically between tens to hundreds of nH. When the IGBTs turns off, the energy in the stray inductance will appear as overvoltage on IGBT and eventually dissipate as heat on the IGBT. However, for DC-breaker applications, the stray inductance/reactor ranges from a few mH (MVDC distribution) to hundreds of mH (HVDC transmission). In fact, in HVDC system, these energy storage components mainly come from valve reactors rather than stray inductance. Obviously, for DC-breaker applications, energy that is stored in stray inductance/reactors cannot be dissipated on IGBTs. Instead, these energies have to be dissipated in MOV surge arresters, by commutating DC fault current from IGBT to MOV.

6 Summary

The DC-breaker is a new type of equipment that attracts a number of innovative designs, very often involving heavy use of power semiconductor switches. Among power semiconductor devices, PP-IGBT is the primary choice for such an application, thanks to its SFCM, extremely high current ratings and very high surge current capabilities. Furthermore, T2960BB45E is one of the most powerful PP-IGBT devices available on market, which makes it a perfect candidate for DC-breaker applications.

Design of DC-breakers requires a lot of knowledge and skills, which is beyond the scope of this study. Instead, this application note focuses on critical design considerations for PP-IGBTs when used in DC-breakers. It starts with general working principle of DC-breakers, and then introduces two core requirements on PP-IGBT, that is, very high current withstanding and turn-off capabilities. To cope with these requirements, key setup or arrangement for PP-IGBT needs to be made, such as an elevated gate voltage to avoid desaturation, lower DC-link voltage per IGBT level, proper snubber circuit design, and suitable MOV surge arrester.

Through manual calculation, simulation study, lab bench demonstration testing and full-scale testing from a third party, it proves that the PP-IGBT T2960BB45E is a superb device for DC-breaker applications, for 15kA and beyond.

7 Disclaimer

The guidance given herein is provided for information only and IXYS UK Westcode in no way implies any warranty for devices operated outside of the maximum ratings as specified in the datasheet.

Any application of devices beyond maximum ratings should be thoroughly qualified and validated on an individual basis.

IXYS Semiconductor GmbH
Edisonstraße 15
D-68623 Lampertheim
Tel: +49 6206 503-0
Fax: +49 6206 503-627
E-mail: marcom@ixys.de



IXYS Corporation
1590 Buckeye Drive
Milpitas CA 95035-7418 USA
Tel: +1 (408) 457 9000
Fax: +1 (408) 496 0670
E-mail: sales@ixys.net

www.ixysuk.com

www.ixys.com

IXYS UK Westcode Ltd
Langley Park Way, Langley Park,
Chippenham, Wiltshire, SN15 1GE.
Tel: +44 (0) 1249 444524
Fax: +44 (0) 1249 659448
E-mail: sales@ixysuk.com

IXYS Long Beach
2500 Mira Mar Avenue
Long Beach CA 90815 USA
Tel: +1 (562) 296 6584
Fax: +1 (562) 296 6585
E-mail: service@ixyslongbeach.com

The information contained herein is protected by Copyright. And may not be used, copied, stored or disclosed except with the written permission of and in the manner permitted by the proprietors IXYS UK Westcode Ltd.

© IXYS UK Westcode Ltd.

In the interest of product improvement, IXYS UK Westcode reserves the right to change specifications or application notes at any time without prior notice.

Important Notice:

This document is provided by Littelfuse, Inc. ("Littelfuse") for informational and guideline purposes only. Littelfuse assumes no liability for errors or omissions in this document or for any of the information contained herein. Information is provided on an "as is" and "with all faults" basis for evaluation purposes only. Applications described are for illustrative purposes only and Littelfuse makes no representation that such applications will be suitable for the customer's specific use without further testing or modification. Littelfuse expressly disclaims all warranties, whether express, implied or statutory, including but not limited to the implied warranties of merchantability and fitness for a particular purpose, and non-infringement. It is the customer's sole responsibility to determine suitability for a particular system or use based on their own performance criteria, conditions, specific application, compatibility with other components, and environmental conditions. Customers must independently provide appropriate design and operating safeguards to minimize any risks associated with their applications and products.

LITTELFUSE PRODUCTS ARE NOT DESIGNED FOR, AND SHALL NOT BE USED FOR, ANY PURPOSE (INCLUDING, WITHOUT LIMITATION, AUTOMOTIVE, MILITARY, AEROSPACE, MEDICAL, LIFE-SAVING, LIFE-SUSTAINING OR NUCLEAR FACILITY APPLICATIONS, DEVICES INTENDED FOR SURGICAL IMPLANT INTO THE BODY, OR ANY OTHER APPLICATION IN WHICH THE FAILURE OR LACK OF DESIRED OPERATION OF THE PRODUCT MAY RESULT IN PERSONAL INJURY, DEATH, OR PROPERTY DAMAGE) OTHER THAN THOSE EXPRESSLY SET FORTH IN APPLICABLE LITTELFUSE PRODUCT DOCUMENTATION. WARRANTIES GRANTED BY LITTELFUSE SHALL BE DEEMED VOID FOR PRODUCTS USED FOR ANY PURPOSE NOT EXPRESSLY SET FORTH IN APPLICABLE LITTELFUSE DOCUMENTATION. LITTELFUSE SHALL NOT BE LIABLE FOR ANY CLAIMS OR DAMAGES ARISING OUT OF PRODUCTS USED IN APPLICATIONS NOT EXPRESSLY INTENDED BY LITTELFUSE AS SET FORTH IN APPLICABLE LITTELFUSE DOCUMENTATION.