

Switchable Current Regulators

IXCP 10M45S
IXCY 10M45S

$V_{AK} = 450 \text{ V}$
 $I_{A(P)} = 2 - 100 \text{ mA}$
 $R_{DYN} = 9 - 900 \text{ k}\Omega$

Symbol	Test Condition	Maximum Ratings	
V_{AKR}	$T_J = 25^\circ\text{C to } 150^\circ\text{C}$	10M35S	450 V
V_{AGR}	$T_J = 25^\circ\text{C to } 150^\circ\text{C}$	10M35S	450 V
V_{GK}			± 20 V
I_D	$T_C = 25^\circ\text{C}$		-0.3 A
P_D	$T_C = 25^\circ\text{C}$		40 W
T_J			-55 ... +150 $^\circ\text{C}$
T_{stg}			-55 ... +150 $^\circ\text{C}$
T_L	Temperature for Soldering (max. 10 s)		260 $^\circ\text{C}$
M_D	Mounting torque with screw M3 (TO-220) with screw M3.5 (TO-220)	0.45/4 0.55/5	Nm/lb.in. Nm/lb.in.

TO-220 AB (IXCP)

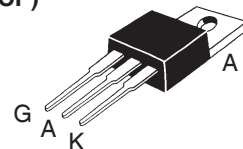

TO-252 AA (IXCY)

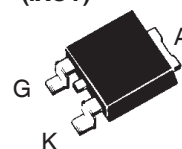

Pin connections

1 = G, Control terminal;
2 and 4 = A (+) Positive terminal
3 = K (-), Negative terminal

Features

- Minimum of 350/450 V breakdown
- Resistor programmable current source
- 40 W continuous dissipation
- International standard packages JEDEC TO-220 and TO-252
- On/Off switchable current source

Applications

- Start-up circuits for SMPS
- Highly stable voltage sources
- Surge limiters and voltage protection
- Instantaneously reacting resettable fuses
- Soft start-up circuits

Symbol	Test Condition	Characteristic Values ($T_J = 25^\circ\text{C}$ unless otherwise specified)		
		min.	typ.	max.
V_{AKR}	$R_K = 300 \Omega$, (Fig. 4)	10M35S	450	V
$I_{A(P)}$	$V_D = 10 \text{ V}$; $R_K = 300 \Omega$; (Fig. 5)		7	10 15 mA
$V_{G(off)}$	$I_D = 100 \mu\text{A}$; $V_D = 400 \text{ V}$ Fig. 4	10M45S	-5	V
I_{AV}	$V_D = 400 \text{ V}$; $V_{GK} = -10 \text{ V}$ Fig. 4	10M45S		25 μA
$\Delta V_{AK} / \Delta I_{A(p)}$	Dynamic resistance; $V_D = 10 \text{ V}$ $R_K = 300 \Omega$; (Fig. 4)		160	k Ω
R_{thJC}	Thermal Resistance junction-to-case			3.1 K/W
R_{thJA}	Thermal Resistance junction-to-ambient	TO-220		80 K/W
		TO-252		100 K/W

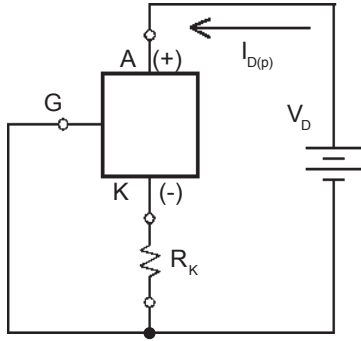

Fig. 1 Resistor R_K in series with negative pin to achieve different current levels

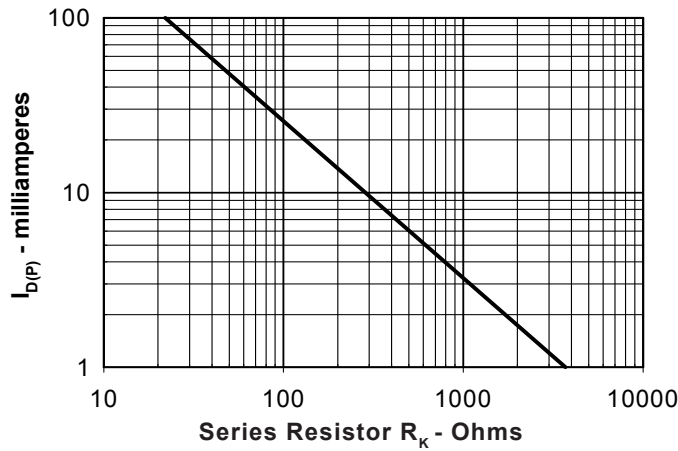

Fig. 2. Plateau current versus external resistance

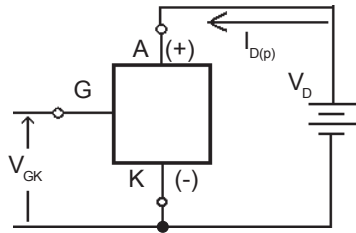

Fig. 3. Current regulator controlled by V_G

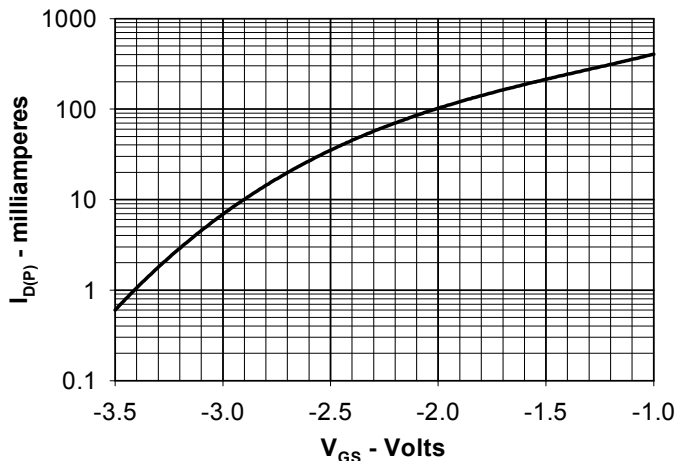
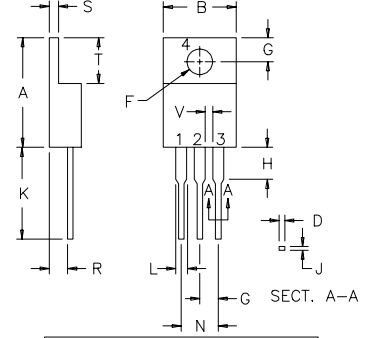

Fig. 4. Plateau current versus applied input voltage

TO-220 AB Outline



Dim.	Millimeter		Inches	
	Min.	Max.	Min.	Max.
A	14.23	16.51	.560	.650
B	9.66	10.66	.380	.420
C	3.56	4.82	.140	.190
D	0.64	0.89	.025	.035
F	3.54	4.06	.139	.161
G	2.29	2.79	.090	.110
H	-	6.35	-	.250
J	0.51	0.76	.020	.030
K	12.70	14.73	.500	.580
L	1.15	1.77	.045	.070
N	4.83	5.33	.190	.210
Q	2.54	3.42	.100	.135
R	2.04	2.49	.080	.115
S	0.64	1.39	.025	.055
T	5.85	6.85	2.30	2.70
V	1.15	-	.045	-

TO-252 AA Outline

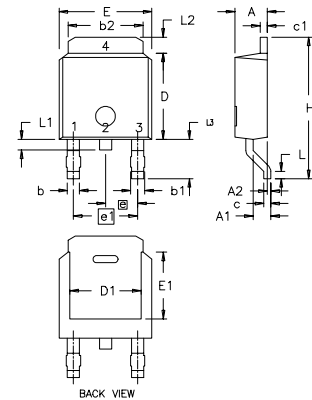

Dim.	Millimeter		Inches	
	Min.	Max.	Min.	Max.
A	2.19	2.38	0.086	0.094
A1	0.89	1.14	0.035	0.045
A2	0	0.13	0	0.005
b	0.64	0.89	0.025	0.035
b1	0.76	1.14	0.030	0.045
b2	5.21	5.46	0.205	0.215
c	0.46	0.58	0.018	0.023
c1	0.46	0.58	0.018	0.023
D	5.97	6.22	0.235	0.245
D1	4.32	5.21	0.170	0.205
E	6.35	6.73	0.250	0.265
E1	4.32	5.21	0.170	0.205
e	2.28	BSC	0.090	BSC
e1	4.57	BSC	0.180	BSC
H	9.40	10.42	0.370	0.410
L	0.51	1.02	0.020	0.040
L1	0.64	1.02	0.025	0.040
L2	0.89	1.27	0.035	0.050
L3	2.54	2.92	0.100	0.115

IXYS reserves the right to change limits, test conditions, and dimensions.

IXYS MOSFETs and IGBTs are covered by one or more of the following U.S. patents:

4,835,592	4,931,844	5,049,961	5,237,481	6,162,665	6,404,065 B1	6,683,344	6,727,585
4,850,072	5,017,508	5,063,307	5,381,025	6,259,123 B1	6,534,343	6,710,405 B2	
4,881,106	5,034,796	5,187,117	5,486,715	6,306,728 B1	6,583,505	6,710,463	