

Switchable Current Regulators

IXCP10M90S IXCY10M90S

$$V_{AK} = 900V$$

$$I_{A(p)} = 1 - 100mA$$

$$R_{AK(typ)} = 58k\Omega$$

Symbol	Test Conditions	Maximum Ratings	
V_{AKR}	$T_J = 25^\circ C$ to $150^\circ C$	900	V
V_{AGR}	$T_J = 25^\circ C$ to $150^\circ C$	900	V
V_{GKR}		± 20	V
I_A	$T_C = 25^\circ C$	0.3	A
P_D	$T_C = 25^\circ C$	40	W
T_J		- 55 ... +150	$^\circ C$
T_{JM}		150	$^\circ C$
T_{stg}		- 55 ... +150	$^\circ C$
T_L	1.6mm (0.062 in.) from Case for 10s	300	$^\circ C$
T_{SOLD}	Plastic Body for 10s	260	$^\circ C$
M_d	Mounting Torque (TO-220)	1.13 / 10	Nm/lb.in.
Weight	TO-252	0.35	g
	TO-220	3.00	g

TO-252 (IXCY)

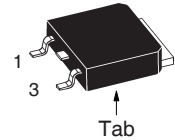

TO-220AB (IXCP)



Pin connections

1 = G, Control Terminal,
2 and Tab = A (+), Positive Terminal
3 = K (-), Negative Terminal

Features

- 40W Continuous Dissipation
- International Standard Packages JEDEC TO-220 and TO-252
- On/Off Switchable Current Source

Applications

- Start-Up Circuits for SMPS
- Highly Stable Voltage Sources
- Surge Limiters and Voltage Protection
- Fast Reacting Resettable Fuses
- Soft Start-Up Circuits

Symbol	Test Conditions ($T_J = 25^\circ C$, Unless Otherwise Specified)	Characteristic Values		
		Min.	Typ.	Max.
V_{AKR}	$R_K = 300\Omega$, (Fig. 1)	900		V
$I_{A(p)}$	$V_D = 10V$, $R_K = 300\Omega$, (Fig. 1)	7	9	15 mA
$V_{GK(off)}$	$I_{A(p)} = 100\mu A$, $V_D = 900V$, (Fig. 3)	- 5		V
$I_{A(p)}$	$V_D = 720V$, $V_{GK} = -10V$			25 μA
$\Delta V_{AK} / \Delta I_{A(p)}$	Dynamic Resistance, $V_D = 100V$ $V_{GK} = 0V$	30		k Ω
R_{thJC}	Thermal Resistance Junction-to-Case			3.1 K/W
R_{thJA}	Thermal Resistance Junction-to-Ambient TO-220			80 K/W
	TO-252			100 K/W



Fig. 1 Resistor R_K in Series with Negative Pin to Achieve Different Current Levels



Fig. 2. Plateau Current vs. External Resistance

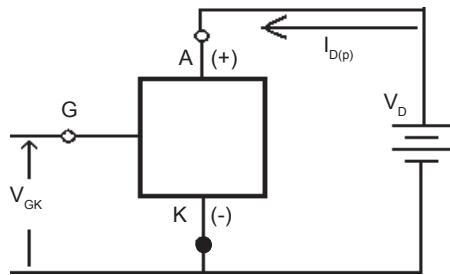

Fig. 3. Current Regulator Controlled by V_{GK}



Fig. 4. Plateau Current vs. Applied Input Voltage

TO-252 AA (IXCY)



Dim.	Millimeter		Inches	
	Min.	Max.	Min.	Max.
A	2.19	2.38	0.086	0.094
A1	0.89	1.14	0.035	0.045
A2	0	0.13	0	0.005
b	0.64	0.89	0.025	0.035
b1	0.76	1.14	0.030	0.045
b2	5.21	5.46	0.205	0.215
c	0.46	0.58	0.018	0.023
c1	0.46	0.58	0.018	0.023
D	5.97	6.22	0.235	0.245
D1	4.32	5.21	0.170	0.205
E	6.35	6.73	0.250	0.265
E1	4.32	5.21	0.170	0.205
e	2.28 BSC		0.090 BSC	
e1	4.57 BSC		0.180 BSC	
H	9.40	10.42	0.370	0.410
L	0.51	1.02	0.020	0.040
L1	0.64	1.02	0.025	0.040
L2	0.89	1.27	0.035	0.050
L3	2.54	2.92	0.100	0.115

TO-220 (IXCP) Outline

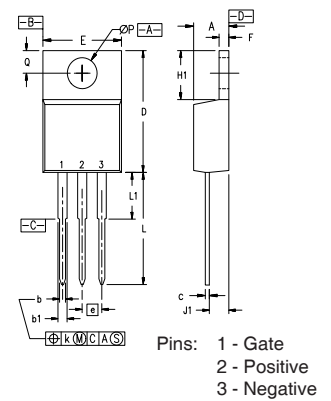

SYM	INCHES		MILLIMETERS	
	MIN	MAX	MIN	MAX
A	.170	.190	4.32	4.83
b	.025	.040	0.64	1.02
b1	.045	.065	1.15	1.65
c	.014	.022	0.35	0.56
D	.580	.630	14.73	16.00
E	.390	.420	9.91	10.66
e	.100 BSC		2.54 BSC	
F	.045	.055	1.14	1.40
H1	.230	.270	5.85	6.85
J1	.090	.110	2.29	2.79
k	0	.015	0	0.38
L	.500	.550	12.70	13.97
L1	.110	.230	2.79	5.84
ØP	.139	.161	3.53	4.08
Q	.100	.125	2.54	3.18

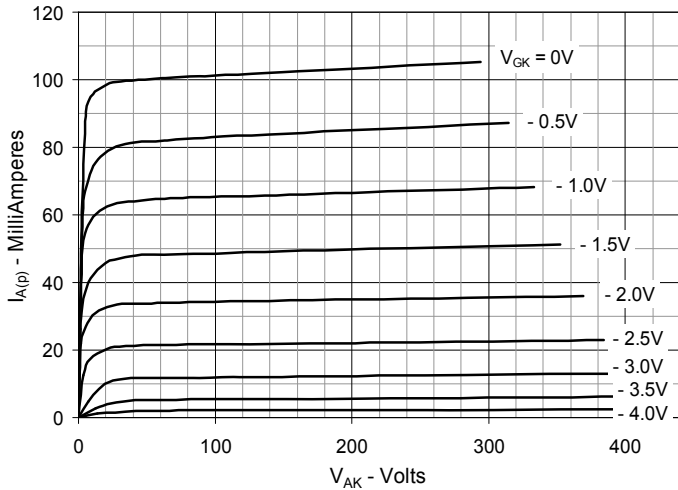

Fig. 5. Extended Output Curves @ $T_J = 25^\circ\text{C}$

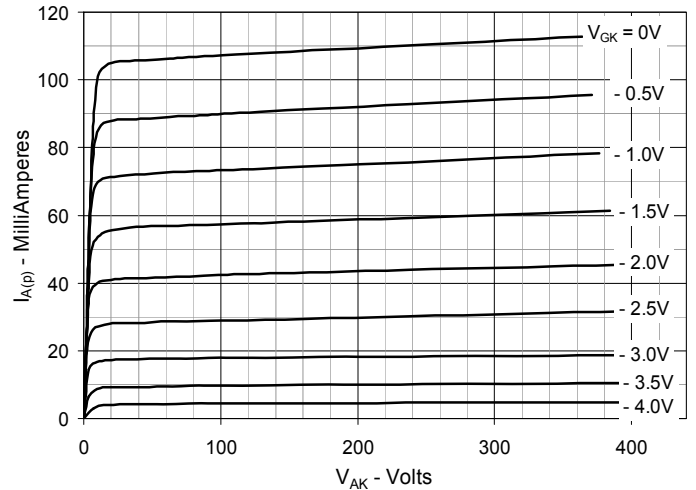

Fig. 6. Extended Output Curves @ $T_J = 125^\circ\text{C}$

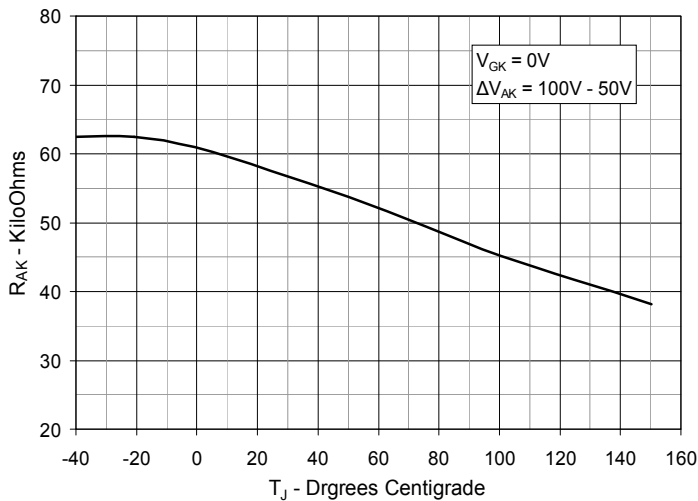

Fig. 7. Dynamic Resistance vs. Junction Temperature

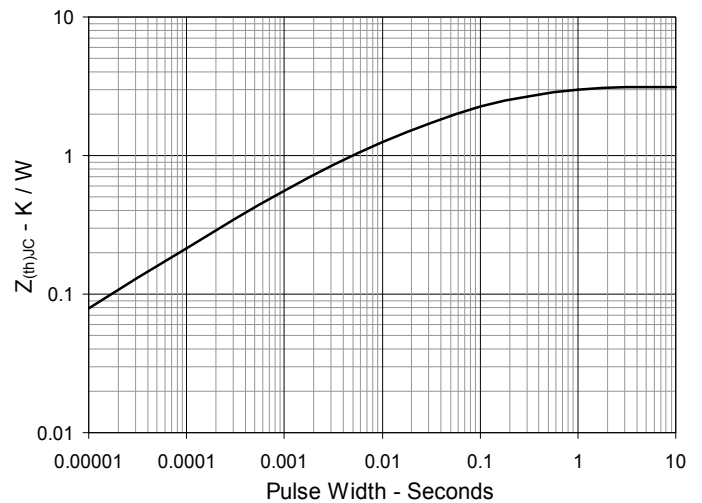

Fig. 8. Maximum Transient Thermal Resistance

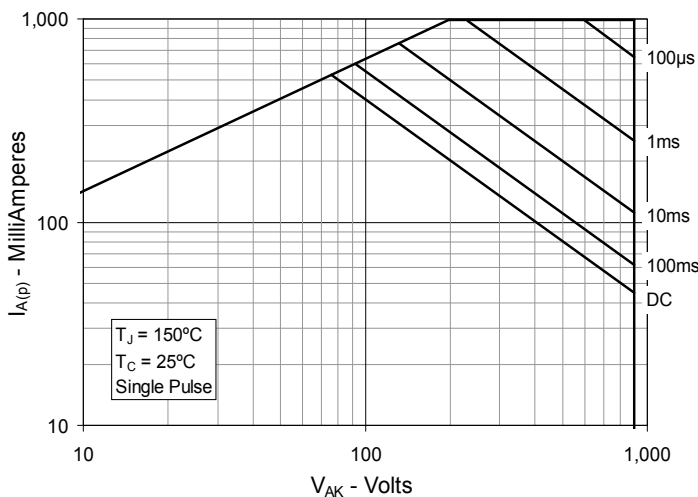

Fig. 9. Forward-Bias Safe Operating Area @ $T_C = 25^\circ\text{C}$

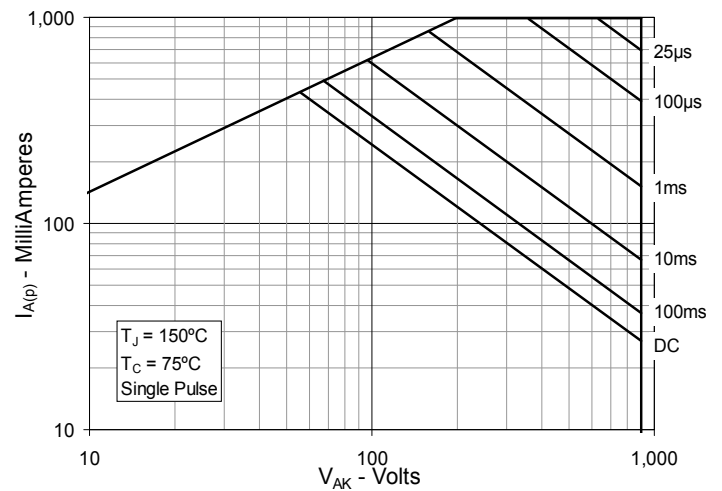

Fig. 10. Forward-Bias Safe Operating Area @ $T_C = 75^\circ\text{C}$