

 Date: 6th April 2023

Data Sheet Issue: 2

Medium Voltage Thyristor

Types K1351V#600 to K1351V#650

(Development part No.: KX120V#600-650)

Absolute Maximum Ratings

	VOLTAGE RATINGS	MAXIMUM LIMITS	UNITS
V _{DRM}	Repetitive peak off-state voltage, (note 1)	6000-6500	V
V _{DSM}	Non-repetitive peak off-state voltage, (note 1)	6000-6500	V
V _{RRM}	Repetitive peak reverse voltage, (note 1)	6000-6500	V
V _{RSM}	Non-repetitive peak reverse voltage, (note 1)	6100-6600	V

	OTHER RATINGS	MAXIMUM LIMITS	UNITS
I _{T(AV)}	Mean on-state current, T _{sink} =55°C, (note 2)	1351	A
I _{T(AV)}	Mean on-state current. T _{sink} =85°C, (note 2)	859	A
I _{T(AV)}	Mean on-state current. T _{sink} =85°C, (note 3)	526	A
I _{T(RMS)}	Nominal RMS on-state current, T _{sink} =25°C, (note 2)	2728	A
I _{T(d.c.)}	D.C. on-state current, T _{sink} =25°C, (note 4)	2419	A
I _{TSM}	Peak non-repetitive surge t _p =10ms, V _{rm} =0.6V _{RRM} , (note 5)	14.3	kA
I _{TSM2}	Peak non-repetitive surge t _p =10ms, V _{rm} ≤10V, (note 5)	15.8	kA
I ² t	I ² t capacity for fusing t _p =10ms, V _{rm} =0.6V _{RRM} , (note 5)	1.02×10 ⁶	A ² s
I ² t	I ² t capacity for fusing t _p =10ms, V _{rm} ≤10V, (note 5)	1.25×10 ⁶	A ² s
(di/dt) _{cr}	Critical rate of rise of on-state current (Note 6)	continuous, 50Hz	75
		repetitive, 50Hz, 60s	150
		non-repetitive	300
V _{RGM}	Peak reverse gate voltage	5	V
P _{G(AV)}	Mean forward gate power	3	W
P _{GM}	Peak forward gate power	40	W
T _{HS}	Operating temperature range	-40 to +115	°C
T _{stg}	Storage temperature range	-40 to +150	°C

Notes: -

- 1) De-rating factor of 0.13% per °C is applicable for T_j below 25°C.
- 2) Double side cooled, single phase; 50Hz, 180° half-sinewave.
- 3) Single side cooled, single phase; 50Hz, 180° half-sinewave.
- 4) Double side cooled.
- 5) Half-sinewave, 115°C T_j initial.
- 6) V_D=67% V_{DRM}, I_{FG}=2A, t_r≤0.5μs, T_{case}=115°C.

Characteristics

	PARAMETER	MIN.	TYP.	MAX.	TEST CONDITIONS (Note 1)	UNITS
V_{TM}	Maximum peak on-state voltage	-	-	3.20	$I_{TM}=3000A$	V
V_{TM}	Maximum peak on-state voltage	-	-	3.85	$I_{TM}=4050A$	V
V_0	Threshold voltage	-	-	1.41		V
r_s	Slope resistance	-	-	0.60		m Ω
$(dv/dt)_{cr}$	Critical rate of rise of off-state voltage	1000	-	-	$V_D=80\% V_{DRM}$, linear ramp, gate o/c	V/ μs
I_{DRM}	Peak off-state current	-	-	100	Rated V_{DRM}	mA
I_{RRM}	Peak reverse current	-	-	100	Rated V_{RRM}	mA
V_{tr}	On-state recovery voltage	-	10	-	$I_T=3 \times I_{T(AV)M}$, $t_p=10ms$, $T_{case}=25^\circ C$	V
V_{GT}	Gate trigger voltage	-	-	3.0	$T_J=25^\circ C$, $V_D=10V$, $I_T=3A$	V
I_{GT}	Gate trigger current	-	-	300		mA
V_{GD}	Gate non-trigger voltage	-	-	0.25		Rated V_{DRM}
I_H	Holding current	-	-	1000	$T_J=25^\circ C$	mA
t_{gd}	Gate-controlled turn-on delay time	-	0.8	1.5	$V_D=67\% V_{DRM}$, $I_T=2000A$, $di/dt=10A/\mu s$, $I_{FG}=2A$, $t_r=0.5\mu s$, $T_J=25^\circ C$	μs
t_{gt}	Turn-on time	-	2.5	4.5		μs
Q_{rr}	Recovered charge	-	7200	-	$I_{TM}=2000A$, $t_p=2000\mu s$, $di/dt=10A/\mu s$, $V_r=100V$	μC
Q_{ra}	Recovered charge, 50% Chord	-	4500	4800		μC
I_{rr}	Reverse recovery current	-	210	-		A
t_{rr}	Reverse recovery time, 50% Chord	-	45	-		μs
t_q	Turn-off time	-	800	-	$I_{TM}=2000A$, $t_p=2000\mu s$, $di/dt=10A/\mu s$, $V_r=100V$, $V_{dr}=80\% V_{DRM}$, $dV_{dr}/dt=20V/\mu s$	μs
		-	1000	-	$I_{TM}=2000A$, $t_p=2000\mu s$, $di/dt=10A/\mu s$, $V_r=100V$, $V_{dr}=80\% V_{DRM}$, $dV_{dr}/dt=200V/\mu s$	
$R_{th(j-hs)}$	Thermal resistance, junction to heatsink	-	-	0.013	Double side cooled	K/W
		-	-	0.026	Single side cooled	K/W
F	Mounting force	27	-	34	(Note 2)	kN
W_t	Weight	-	1000	-	Outline option VC	g
		-	800	-	Outline option VF	

Notes:-

- 1) Unless otherwise indicated $T_J=115^\circ C$.
- 2) For other mounting forces, please consult factory.

Notes on Ratings and Characteristics

1.0 Voltage Grade Table

Voltage Grade	V_{DRM} V_{DSM} V_{RRM} V	V_{RSM} V	V_D V_R DC V
60	6000	6100	3000
65	6500	6600	3250

2.0 Extension of Voltage Grades

This report is applicable to other voltage grades when supply has been agreed by Sales/Production.

3.0 De-rating Factor

A blocking voltage de-rating factor of 0.13%/°C is applicable to this device for T_j below 25°C.

4.0 Repetitive dv/dt

Standard dv/dt is 1000V/μs.

5.0 Rate of rise of on-state current

The maximum un-primed rate of rise of on-state current must not exceed 300A/μs at any time during turn-on on a non-repetitive basis. For repetitive performance, the on-state rate of rise of current must not exceed 150A/μs at any time during turn-on. Note that these values of rate of rise of current apply to the total device current including that from any local snubber network.

6.0 Frequency Ratings

The curves illustrated in figures 17 & 18 are for guidance only and are superseded by the maximum ratings shown on page 1. For operation above line frequency, please consult the factory for assistance.

7.0 Square wave frequency ratings

These ratings are given for load component rate of rise of on-state current of 50A/μs.

8.0 Duty cycle lines

The 100% duty cycle is represented on the frequency ratings by a straight line. Other duties can be included as parallel to the first.

9.0 Snubber Components

When selecting snubber components, care must be taken not to use excessively large values of snubber capacitor or excessively small values of snubber resistor. Such excessive component values may lead to device damage due to the large resultant values of snubber discharge current. If required, please consult the factory for assistance.

10.0 Gate Drive

The nominal requirement for a typical gate drive is illustrated below. An open circuit voltage of at least 30V is assumed. This gate drive must be applied when using the full di/dt capability of the device.

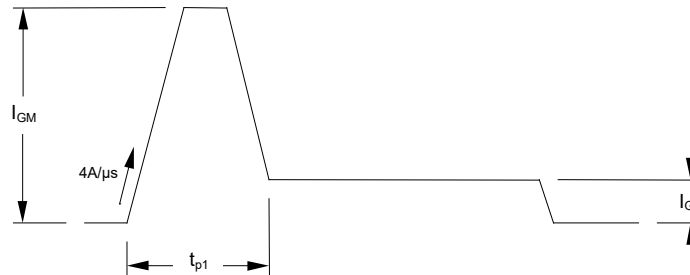

The magnitude of I_{GM} should be between five and ten times I_{GT} , which is shown on page 2. Its duration (t_{p1}) should be $20\mu s$ or sufficient to allow the anode current to reach ten times I_L , whichever is greater. Otherwise, an increase in pulse current could be needed to supply the necessary charge to trigger. The 'back-porch' current I_G should remain flowing for the same duration as the anode current and have a magnitude in the order of 1.5 times I_{GT} .

11.0 Computer Modelling Parameters

11.1 Device Dissipation Calculations

$$I_{AV} = \frac{-V_0 + \sqrt{V_0^2 + 4 \cdot ff \cdot r_s \cdot W_{AV}}}{2 \cdot ff \cdot r_s}$$

and: $\frac{W_{AV}}{R_{th}}$

$$\Delta T = T_{jmax} - T_{Hs}$$

Where $V_0=1.41V$, $r_s=0.6m\Omega$,

R_{th} = Supplementary thermal impedance, see table below and

ff = Form factor, see table below.

Supplementary Thermal Impedance							
Conduction Angle	30°	60°	90°	120°	180°	270°	d.c.
Square wave Double Side Cooled	0.0167	0.0160	0.0152	0.0145	0.0141	0.0134	0.0130
Square wave Single Side Cooled	0.0296	0.0290	0.0282	0.0276	0.0271	0.0264	0.0260
Sine wave Double Side Cooled	0.0161	0.0153	0.0147	0.0143	0.0130		
Sine wave Single Side Cooled	0.0291	0.0283	0.0278	0.0273	0.0260		

Form Factors							
Conduction Angle	30°	60°	90°	120°	180°	270°	d.c.
Square wave	3.464	2.449	2	1.732	1.414	1.149	1
Sine wave	3.98	2.778	2.22	1.879	1.57		

11.2 Calculating V_T using ABCD Coefficients

The on-state characteristic I_T vs. V_T , on page 6 is represented in two ways;

- (i) the well-established V_0 and r_s tangent used for rating purposes and
- (ii) a set of constants A, B, C, D, forming the coefficients of the representative equation for V_T in terms of I_T given below:

$$V_T = A + B \cdot \ln(I_T) + C \cdot I_T + D \cdot \sqrt{I_T}$$

The constants, derived by curve fitting software, are given below for both hot and cold characteristics. The resulting values for V_T agree with the true device characteristic over a current range, which is limited to that plotted.

25°C Coefficients		115°C Coefficients	
A	2.974069977	A	-0.149843723
B	-0.3289658	B	0.3620034
C	2.412020×10^{-4}	C	8.160760×10^{-4}
D	0.03081106	D	-0.03645489

11.3 D.C. Thermal Impedance Calculation

$$r_t = \sum_{p=1}^{p=n} r_p \cdot \left(1 - e^{-\frac{t}{\tau_p}} \right)$$

Where $p = 1$ to n , n is the number of terms in the series and:

t = Duration of heating pulse in seconds.

r_t = Thermal resistance at time t .

r_p = Amplitude of p th term.

τ_p = Time Constant of r th term.

The coefficients for this device are shown in the tables below:

D.C. Double Side Cooled			
Term	1	2	3
r_p	7.871203×10^{-3}	3.460127×10^{-3}	1.478746×10^{-3}
τ_p	0.3818344	0.1099644	5.286858×10^{-3}

D.C. Single Side Cooled				
Term	1	2	3	4
r_p	0.01382285	4.920898×10^{-3}	5.321873×10^{-3}	1.746422×10^{-3}
τ_p	2.409342	1.211641	0.1443263	6.258445×10^{-3}

12.0 Reverse recovery ratings

- (i) Q_{rr} is based on 50% I_{RM} chord as shown in Fig. 1
- (ii) Q_{rr} is based on a $150\mu s$ integration time i.e.

$$Q_{rr} = \int_0^{150\mu s} i_{rr} \cdot dt$$

- (iii) $K \text{ Factor} = \frac{t_1}{t_2}$

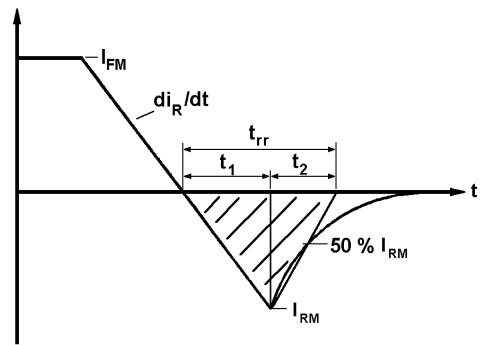

Fig. 1

Curves

Figure 1 - On-state characteristics of Limit device

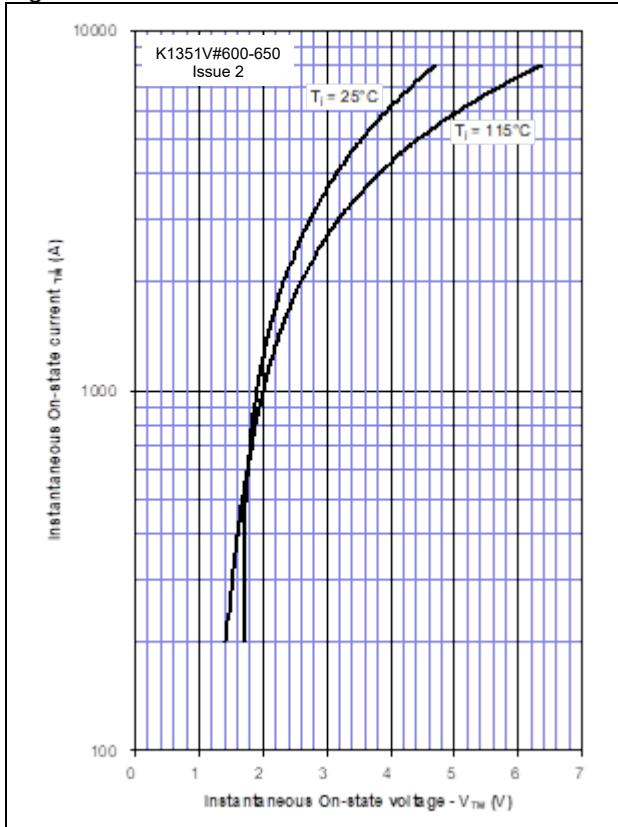

Figure 2 - Transient thermal impedance

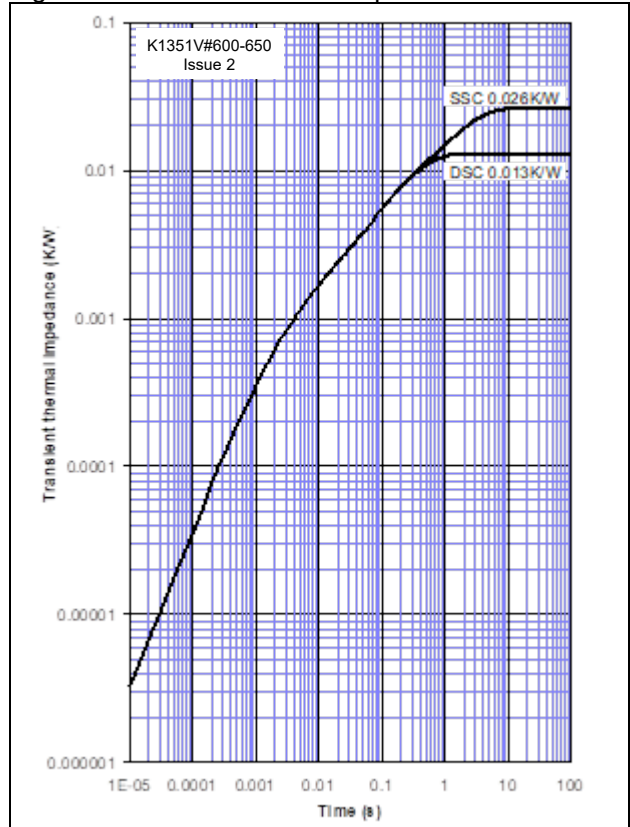

Figure 3 - Gate characteristics - Trigger limits

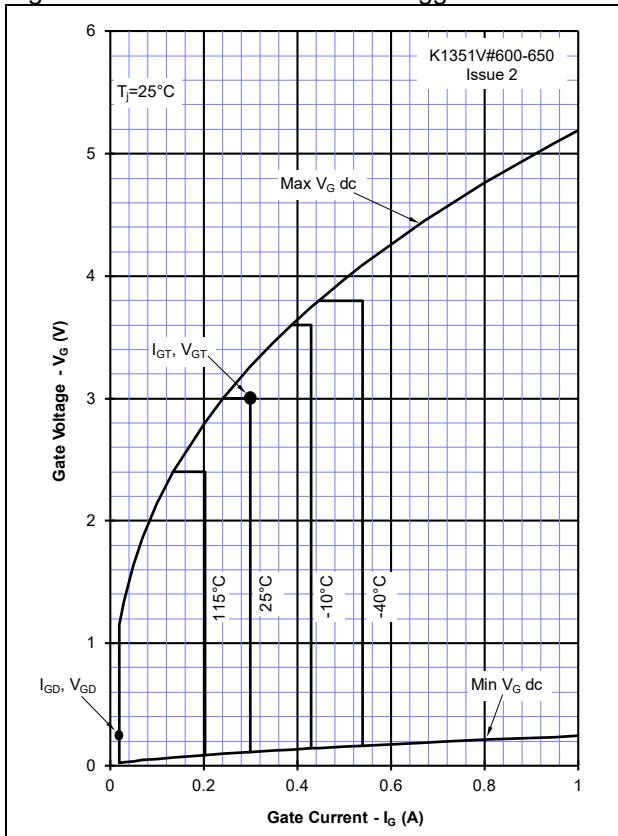

Figure 4 - Gate characteristics - Power curves

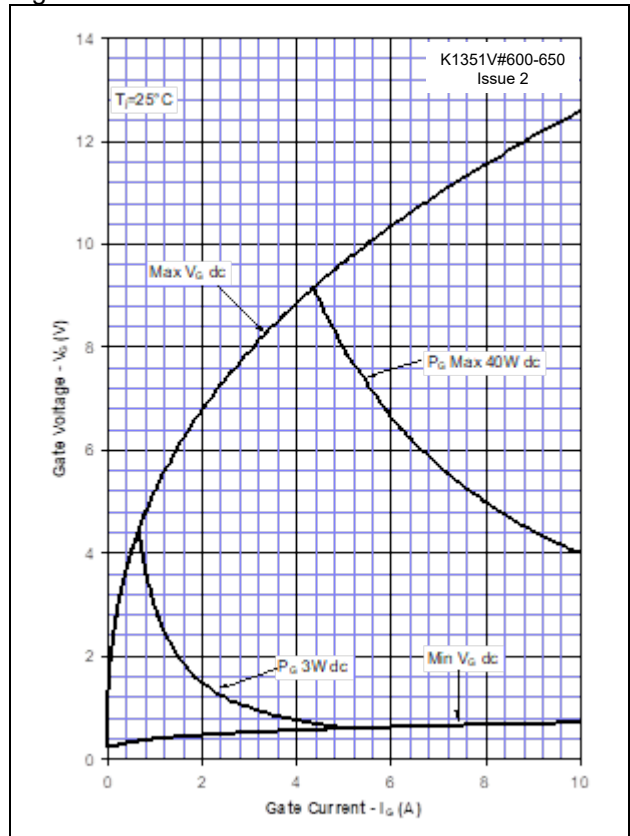

Figure 5 - Total recovered charge, Q_{rr}

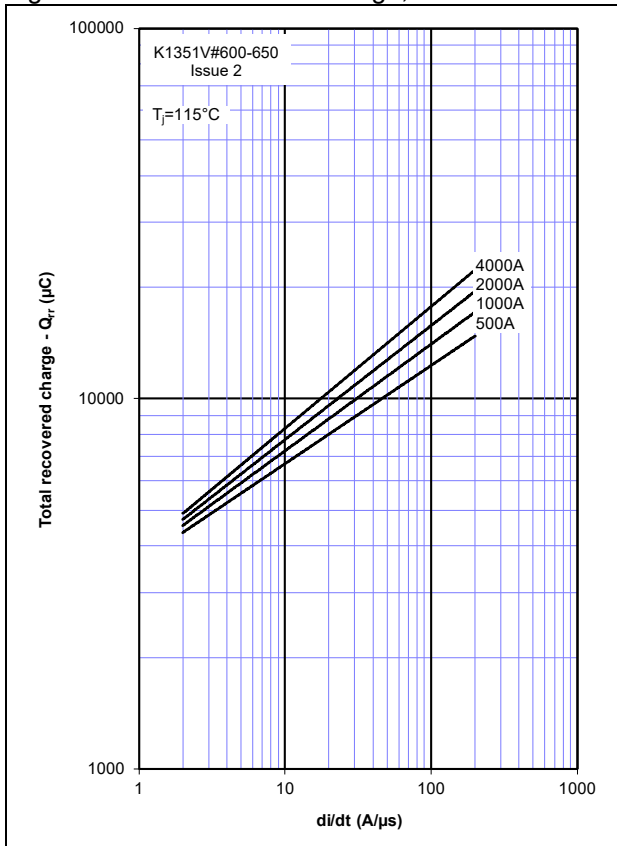

Figure 6 - Recovered charge, Q_{ra} (50% chord)

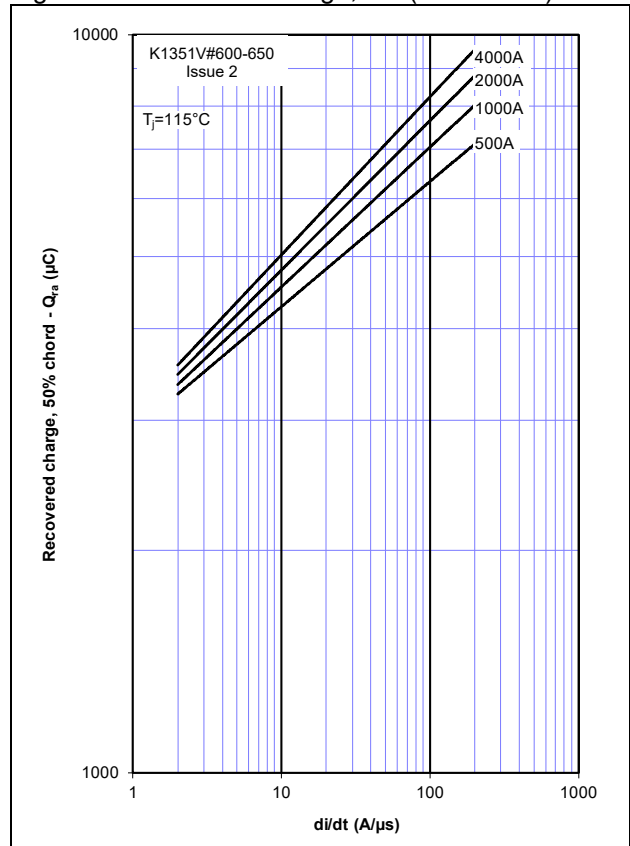

Figure 7 - Peak reverse recovery current, I_{rm}

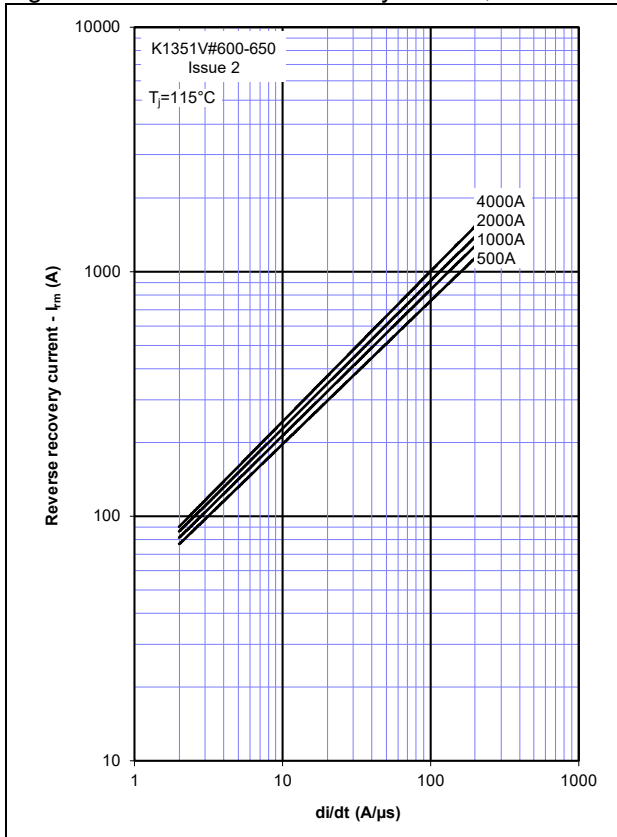

Figure 8 - Maximum recovery time, t_{rr} (50% chord)

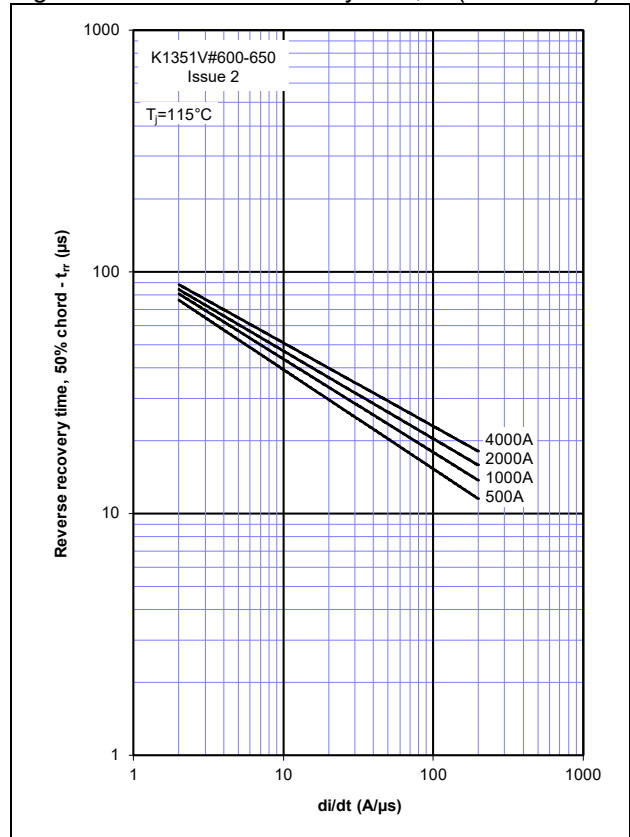

Figure 9 – On-state current vs. Power dissipation – Double Side Cooled (Sine wave)

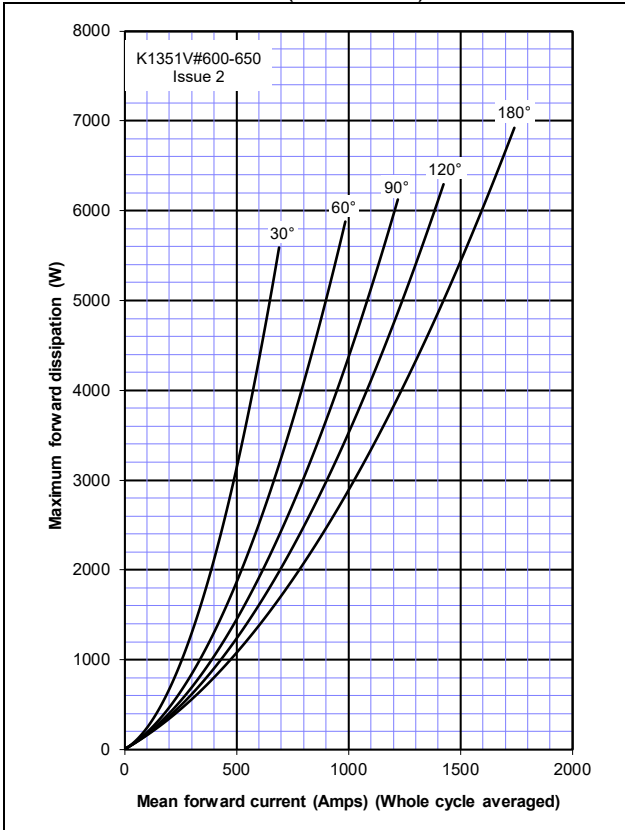

Figure 10 – On-state current vs. Heatsink temperature - Double Side Cooled (Sine wave)

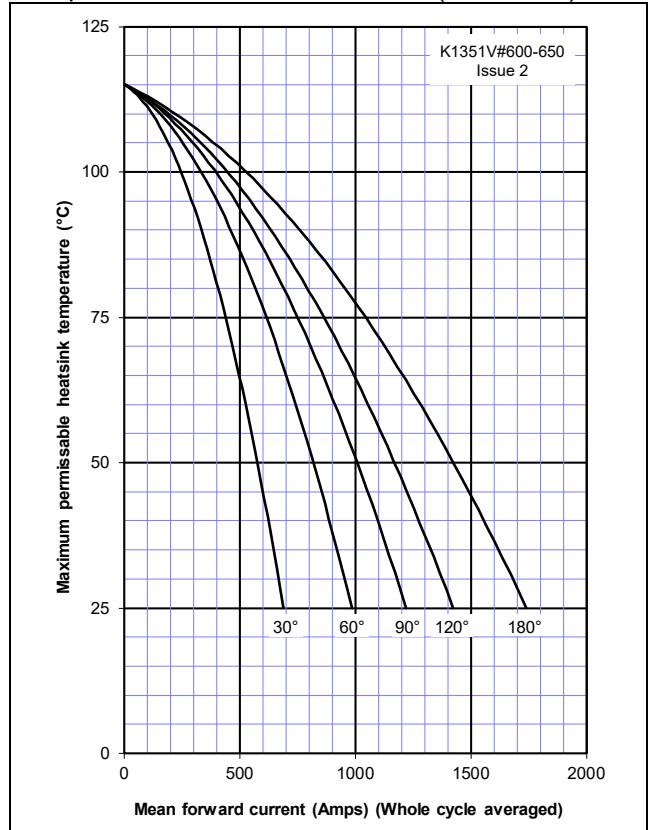

Figure 11 – On-state current vs. Power dissipation – Double Side Cooled (Square wave)

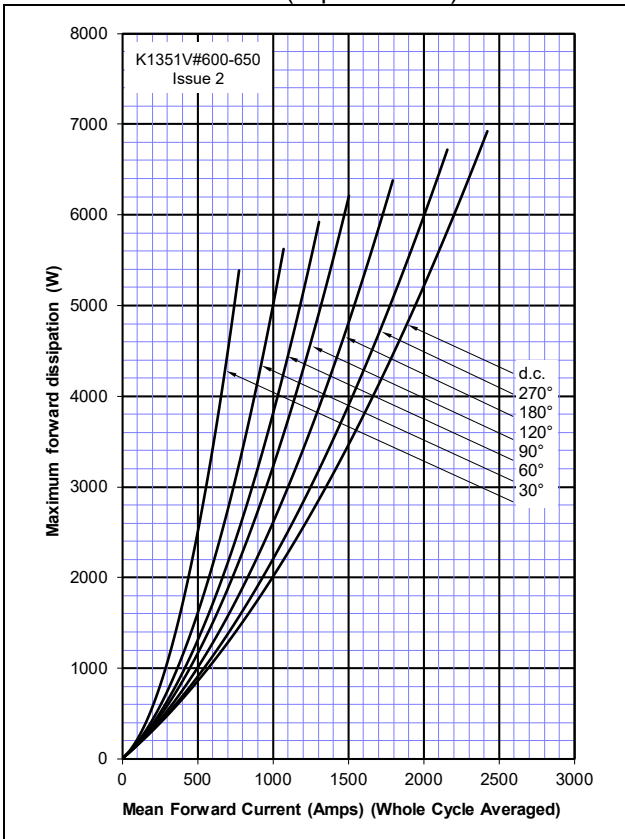

Figure 12 – On-state current vs. Heatsink temperature – Double Side Cooled (Square wave)

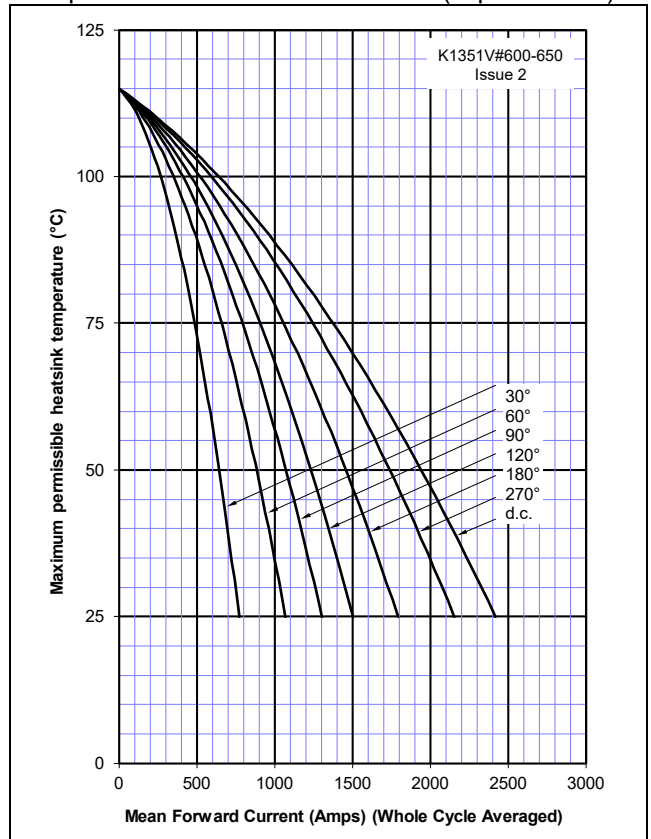

Figure 13 – On-state current vs. Power dissipation – Single Side Cooled (Sine wave)

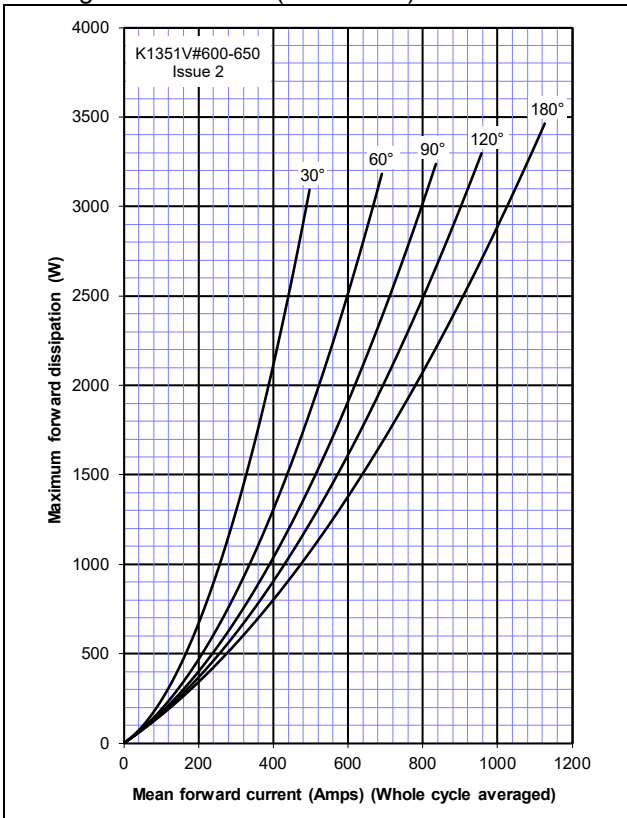

Figure 14 – On-state current vs. Heatsink temperature – Single Side Cooled (Sine wave)

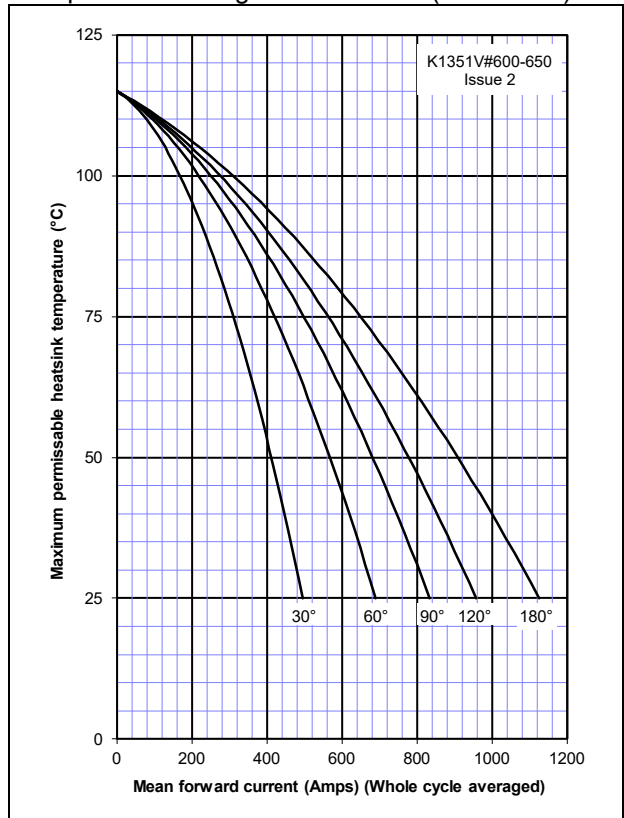

Figure 15 – On-state current vs. Power dissipation – Single Side Cooled (Square wave)

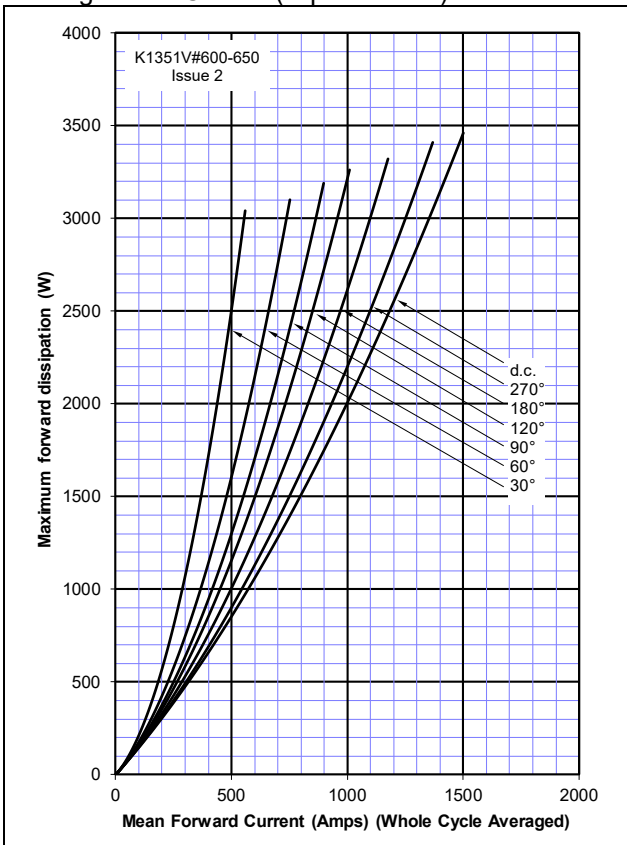

Figure 16 – On-state current vs. Heatsink temperature – Single Side Cooled (Square wave)

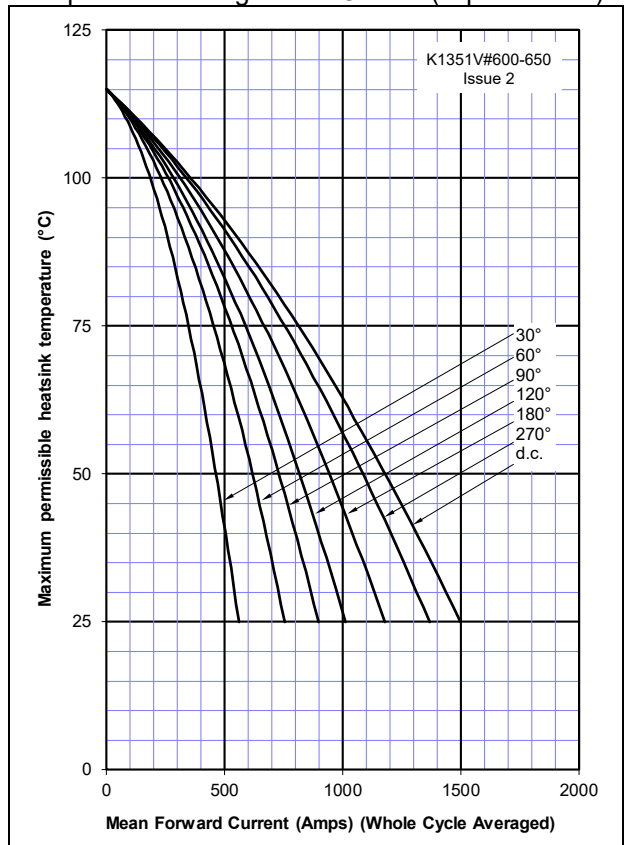

Figure 17 – Square Wave Frequency Ratings

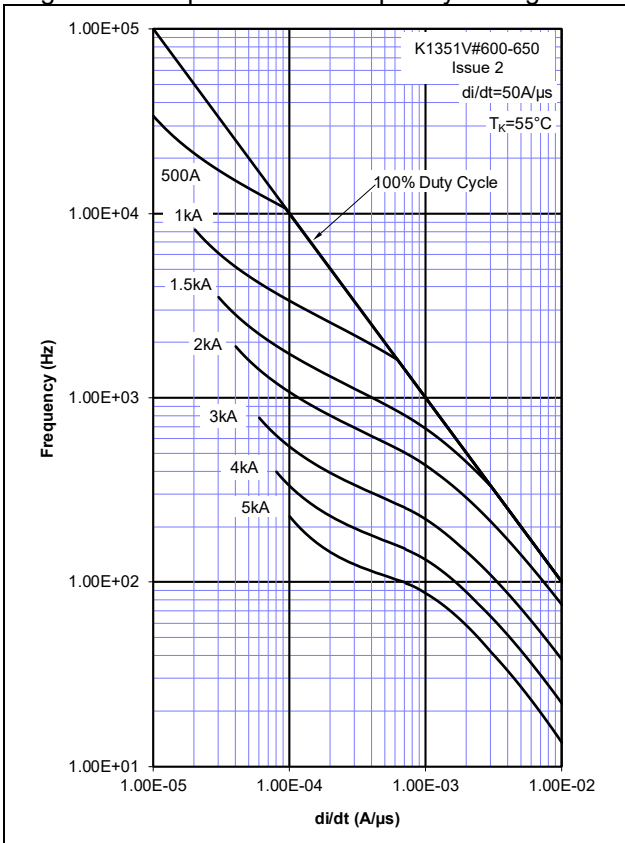

Figure 18 – Sine Wave Frequency Ratings

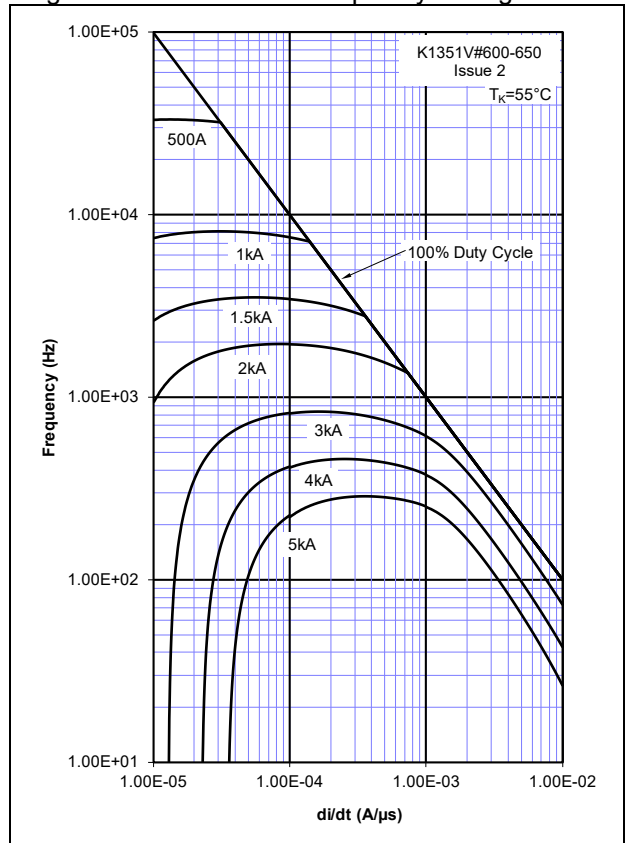
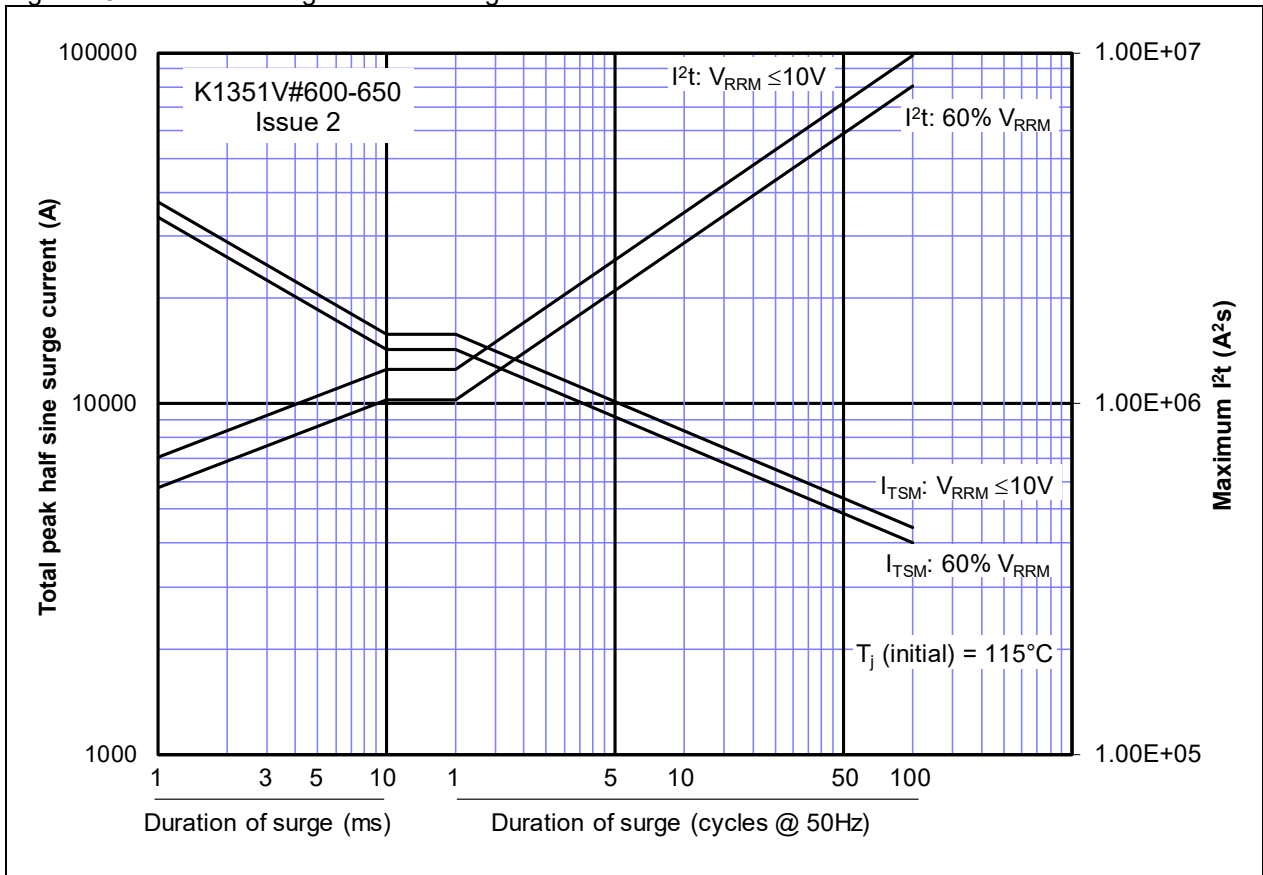
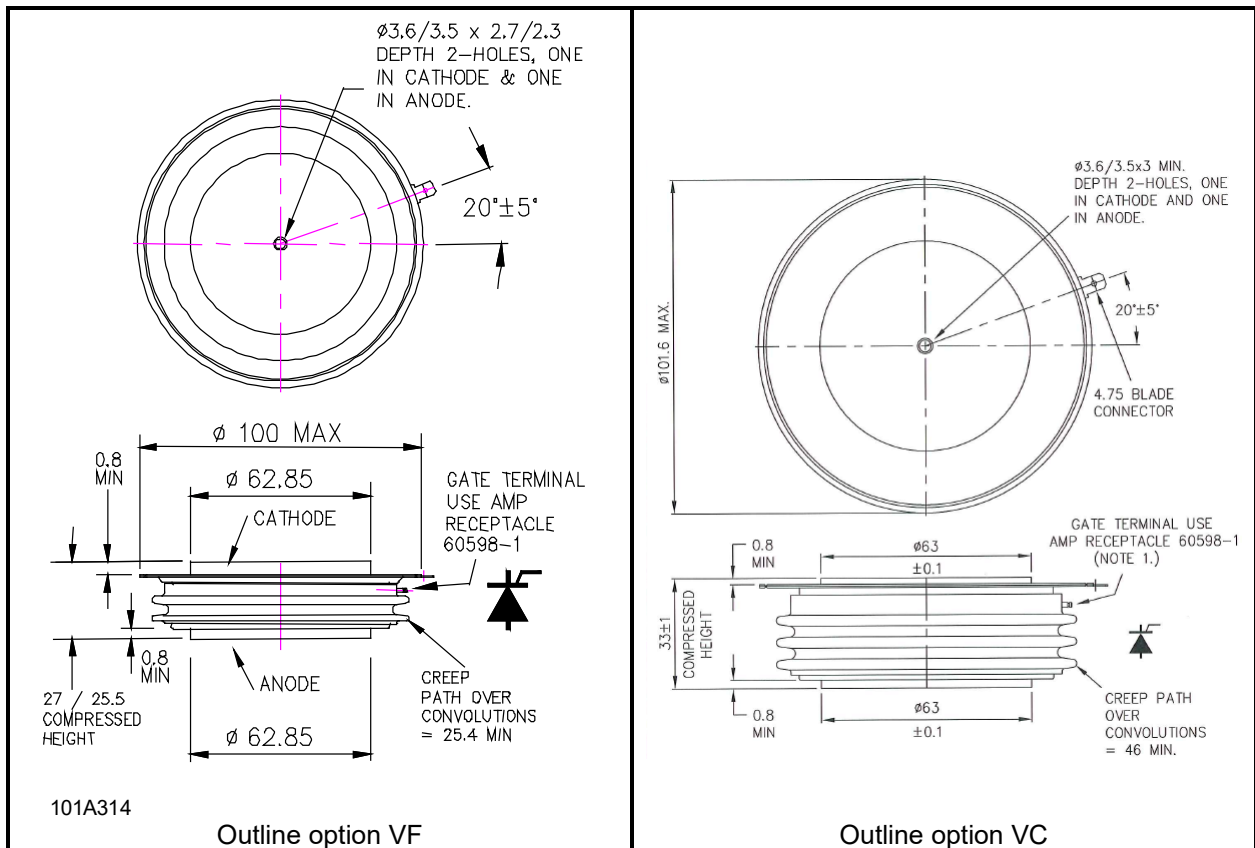

Figure 19 - Maximum surge and I²t Ratings



Outline Drawing & Ordering Information

ORDERING INFORMATION

(Please quote 10 digit code as below)

K1351	V#	◆◆	0
Fixed Type Code	VF=27mm clamped height VC=33mm clamped height	Voltage code $V_{DRM}/100$ 60-65	Fixed turn-off time code

 Order code K1351VF600 – 6000V V_{RRM} , 27mm clamp height capsule.

IXYS UK Westcode Ltd
 Langley Park Way, Langley Park,
 Chippenham, Wiltshire, SN15
 1GE
 Tel: +44 (0)1249 444524
 Fax: +44 (0)1249 659448
 E-mail:
www.littelfuse.com/contactus.aspx



IXYS Long Beach
 IXYS Long Beach, Inc
 2500 Mira Mar Ave, Long Beach
 CA 90815
 Tel: +1 (562) 296 6584
 Fax: +1 (562) 296 6585
 E-mail:
powerstacksus@littelfuse.com

www.littelfuse.com
<https://www.littelfuse.com/products/power-semiconductors/high-power.aspx>

The information contained herein is confidential and is protected by Copyright. The information may not be used or disclosed except with the written permission of and in the manner permitted by the proprietors IXYS UK Westcode Ltd.

© IXYS UK Westcode Ltd.

In the interest of product improvement, IXYS UK Westcode Ltd reserves the right to change specifications at any time without prior notice.

Devices with a suffix code (2-letter, 3-letter, or letter/digit/letter combination) added to their generic code are not necessarily subject to the conditions and limits contained in this report.



Disclaimer Notice - Information furnished is believed to be accurate and reliable. However, users should independently evaluate the suitability of and test each product selected for their own applications. Littelfuse products are not designed for, and may not be used in, all applications. Read complete Disclaimer Notice at www.littelfuse.com/disclaimer-electronics.