

DSTF2050C

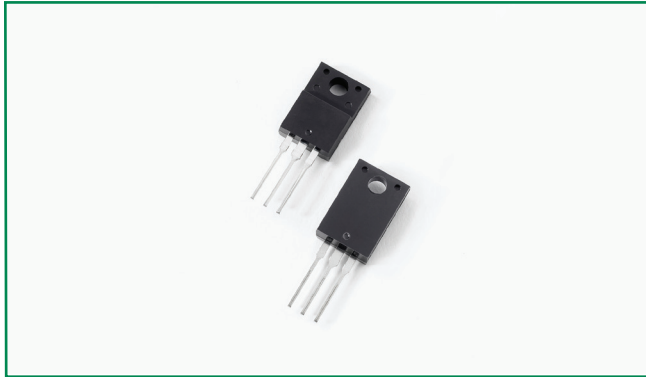

### Pin out

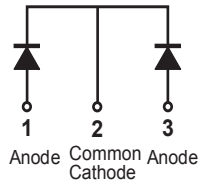

### Description

Littelfuse DST series Ultra Low  $V_F$  Schottky Barrier Rectifier is designed to meet the general requirements of commercial and industry applications by providing high temperature, low leakage and lower  $V_F$  products.

It is suitable for high frequency switching mode power supply, free-wheeling diodes and polarity protection diodes.

### Features

- Ultra low forward voltage drop
- High frequency operation
- High junction temperature capability
- Guard ring for enhanced ruggedness and long term reliability
- Common cathode configuration in ITO-220AB package

### Applications

- Switching mode power supply
- DC/DC converters
- Free-Wheeling diodes
- Polarity Protection Diodes

### Maximum Ratings

Parameters	Symbol	Test Conditions	Max	Unit
Peak Inverse Voltage	$V_{RWM}$	-	50	V
Average Forward Current	$I_{F(AV)}$	50% duty cycle @ $T_c = 110^\circ\text{C}$ rectangular wave form	10 (per leg) 20 (total device)	A
Peak One Cycle Non-Repetitive Surge Current (per leg)	$I_{FSM}$	8.3 ms, half Sine pulse	150	A

### Electrical Characteristics

Parameters	Symbol	Test Conditions	Typ	Max	Unit
Forward Voltage Drop (per leg) *	$V_{F1}$	@5A, Pulse, $T_J = 25^\circ\text{C}$	0.43	0.48	V
		@10A, Pulse, $T_J = 25^\circ\text{C}$	0.49	0.55	
	$V_{F2}$	@5A, Pulse, $T_J = 125^\circ\text{C}$	0.34	-	
		@10A, Pulse, $T_J = 125^\circ\text{C}$	0.44	-	
Reverse Current (per leg) *	$I_{R1}$	@ $V_R = \text{rated } V_R$ , $T_J = 25^\circ\text{C}$	0.01	1.5	mA
	$I_{R2}$	@ $V_R = \text{rated } V_R$ , $T_J = 125^\circ\text{C}$	9	85	

\* Pulse Width < 300 $\mu\text{s}$ , Duty Cycle < 2%

### Thermal-Mechanical Specifications

Parameters	Symbol	Test Conditions	Max	Unit
Junction Temperature	$T_J$		-55 to +150	°C
Storage Temperature	$T_{stg}$		-55 to +150	°C
Thermal Resistance Junction to Case (per leg)	$R_{thJC}$	DC operation	6.0	°C/W
Approximate Weight	wt		2	g
Case Style		ITO-220AB		

**Figure 1: Typical Forward Characteristics**

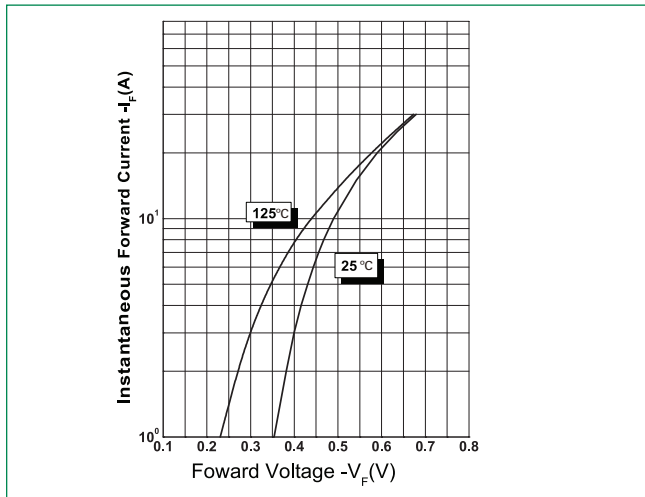

**Figure 2: Typical Reverse Characteristics**

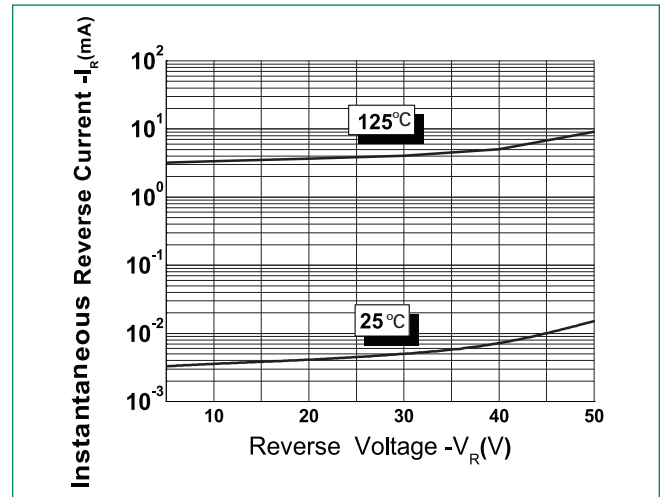

**Figure 3: Typical Junction Capacitance**

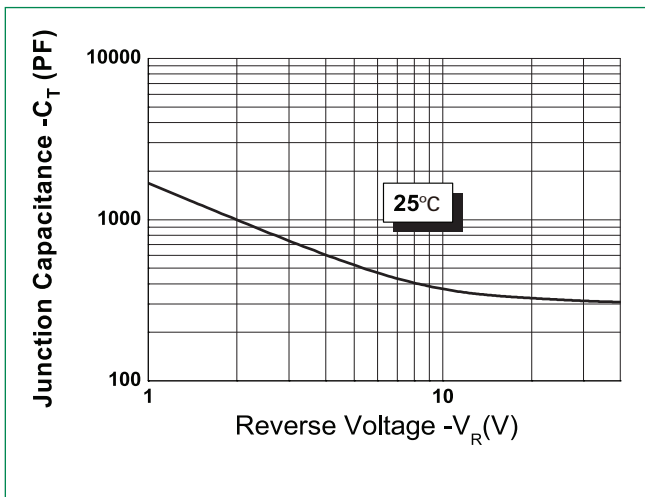

**Dimensions- ITO-220AB**



Symbol	Millimeters		
	Min	Typ	Max
<b>A</b>	4.30	4.50	4.70
<b>A1</b>	1.10	1.30	1.50
<b>A2</b>	2.80	3.00	3.20
<b>A3</b>	2.50	2.70	2.90
<b>b</b>	0.50	0.60	0.75
<b>b1</b>	1.10	1.20	1.35
<b>b2</b>	1.50	1.60	1.75
<b>b3</b>	1.20	1.30	1.45
<b>b4</b>	1.60	1.70	1.85
<b>c</b>	0.55	0.60	0.75
<b>D</b>	14.80	15.00	15.20
<b>E</b>	9.96	10.16	10.36
<b>e</b>		2.55	
<b>e1</b>		5.10	
<b>H1</b>	6.50	6.70	6.90
<b>L</b>	12.70	13.20	13.70
<b>L1</b>	1.60	1.80	2.00
<b>L2</b>	0.80	1.00	1.20
<b>L3</b>	0.60	0.80	1.00
<b>ØP1</b>	3.30	3.50	3.70
<b>ØP2</b>	2.99	3.19	3.39
<b>Q</b>	2.50	2.70	2.90
<b>θ1</b>		5°	
<b>θ2</b>		4°	
<b>θ3</b>		10°	
<b>θ4</b>		5°	
<b>θ5</b>		5°	

**Packing Options**

Part Number	Marking	Packing Mode	M.O.Q
DSTF2050C	DSTF2050C	50pcs / Tube	1000

**Tube Specification**

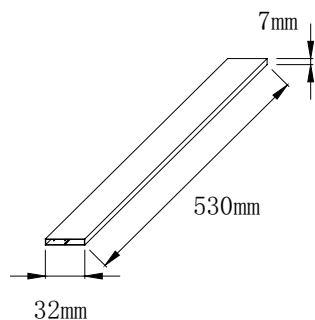

**Part Numbering and Marking System**

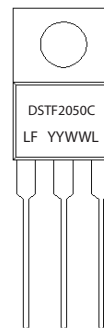

- DST = Device Type
- F = Package type
- 20 = Forward Current (20A)
- 50 = Reverse Voltage (50V)
- C = Configuration
- LF = Littelfuse
- YY = Year
- WW = Week
- L = Lot Number