

LSIC2SD120E20CCA  
1200 V, 2 x 10 A SiC Schottky Barrier Diode

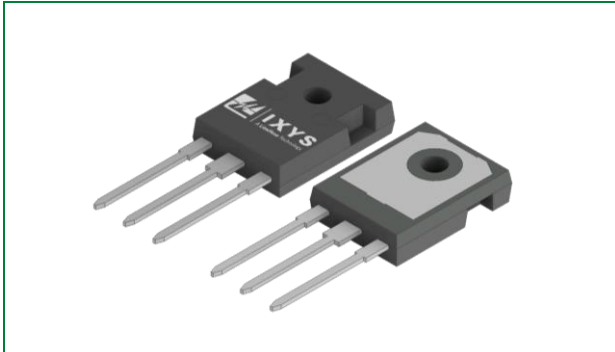

Product Summary

Characteristic	Value	Unit
$V_{RRM}$	1200	V
$I_F (T_c \leq 135\text{ }^\circ\text{C})$	15	A
$Q_c (V_R: 0 - 800\text{ V})$	56	nC

Note:  $I_F$  and  $Q_c$  shown is the per leg rating

Features

- AEC-Q101 qualified
- Positive temperature coefficient for safe operation and ease of paralleling
- 175 °C maximum operating junction temperature
- Excellent surge capability
- Extremely fast, temperature-independent switching behavior
- Dramatically reduced switching losses compared to Si bipolar diodes
- RoHS compliant, lead-free, and halogen-free

Agency Approvals and Environmental

Environmental Approvals



Pinout Diagram TO-247-3L

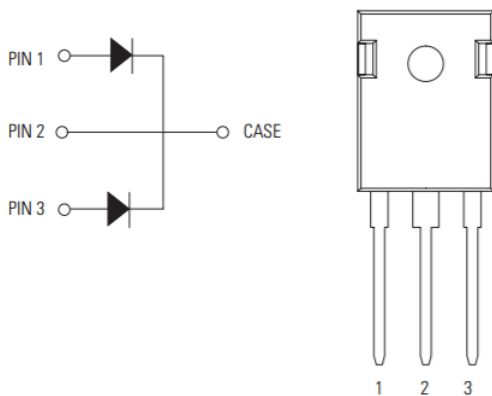

Applications

- Boost diodes in PFC or DC/DC stages
- Switch-mode power supplies
- Solar inverters
- Uninterruptable power supplies
- Industrial motor drives
- Battery chargers
- High speed rectifier

- 1. Maximum Ratings.....3
- 2. Thermal Characteristics .....3
- 3. Electrical Characteristics (Per Leg,  $T_J = 25\text{ }^\circ\text{C}$  unless otherwise specified).....3
- 4. Performance Curves .....4
- 5. Diode  $V_F$  Model for Simulation .....5
- 6. Package Dimensions .....6
- 7. Part Numbering and Marking.....7
- 8. Packing Options .....7
- 9. Packing Specifications .....7

## 1. Maximum Ratings

Characteristic	Symbol	Conditions	Value	Unit
Repetitive Peak Reverse Voltage	$V_{RRM}$	-	1200	V
DC Blocking Voltage	$V_R$	-	1200	V
Continuous Forward Current (Per Leg/Per Component)	$I_F$	$T_C = 25\text{ °C}$	32/64	A
		$T_C = 135\text{ °C}$	15/30	
		$T_C = 154\text{ °C}$	10/20	
Non-repetitive Forward Surge Current (Per Leg)	$I_{FSM}$	$T_C = 25\text{ °C}$ , $t_p = 10\text{ ms}$ , Half sine pulse	80	A
$I^2t$ (Per Leg)	$\int I^2 dt$	$T_C = 25\text{ °C}$ , $t_p = 10\text{ ms}$ , Half sine pulse	32	A <sup>2</sup> s
Power Dissipation (Per Leg/Per Component)	$P_{Tot}$	$T_C = 25\text{ °C}$	150/300	W
		$T_C = 110\text{ °C}$	65/130	
Operating Junction Temperature	$T_J$	-	-55 to 175	°C
Storage Temperature	$T_{STG}$	-	-55 to 150	°C
Lead Temperature for Soldering	$T_{SOLD}$	-	260	°C
Mounting Torque	$M_D$	M3 or 6-32 screw	1.0	Nm
			8.8	In-lb

## 2. Thermal Characteristics

Characteristic	Symbol	Value	Unit
Maximum Thermal Resistance, junction-to-case (Per Leg/Per Component)	$R_{thJC, max}$	1.0/0.5	°C/W

## 3. Electrical Characteristics (Per Leg, $T_J = 25\text{ °C}$ unless otherwise specified)

Characteristic	Symbol	Conditions	Value			Unit
			Min	Typ	Max	
Forward Voltage	$V_F$	$I_F = 10\text{ A}$ , $T_J = 25\text{ °C}$	-	1.5	1.8	V
		$I_F = 10\text{ A}$ , $T_J = 175\text{ °C}$	-	2.0	-	
Reverse Current	$I_R$	$V_R = 1200\text{ V}$ , $T_J = 25\text{ °C}$	-	<1.0	100	μA
		$V_R = 1200\text{ V}$ , $T_J = 175\text{ °C}$	-	4.0	-	
Total Capacitance	C	$V_R = 1\text{ V}$ , $f = 1\text{ MHz}$	-	580	-	pF
		$V_R = 400\text{ V}$ , $f = 1\text{ MHz}$	-	53	-	
		$V_R = 800\text{ V}$ , $f = 1\text{ MHz}$	-	40	-	
Total Capacitive Charge	$Q_C$	$V_R = 800\text{ V}$ , $Q_C = \int C(V) dV$	-	56	-	nC
Capacitance Stored Energy	$E_C$	$V_R = 800\text{ V}$	-	12.8	-	μJ

4. Performance Curves

Figure 1. Typical Forward Characteristics (Per Leg)

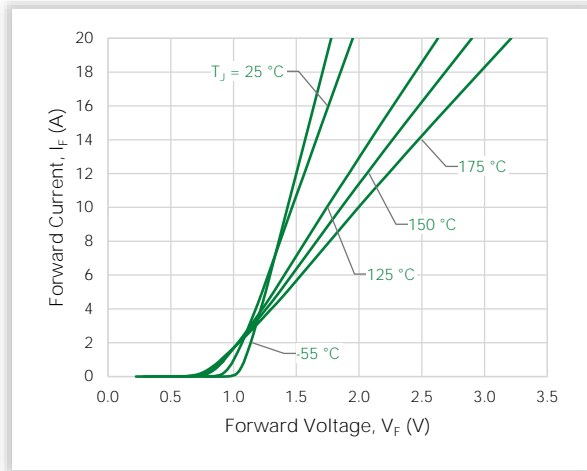

Figure 2. Typical Reverse Characteristics (Per Leg)

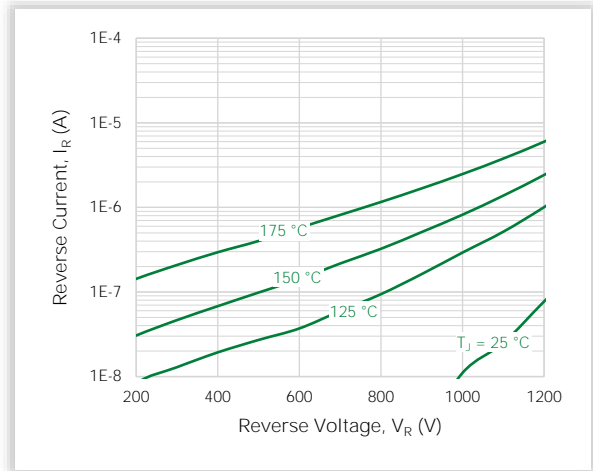

Figure 3. Power Derating (Per Leg)

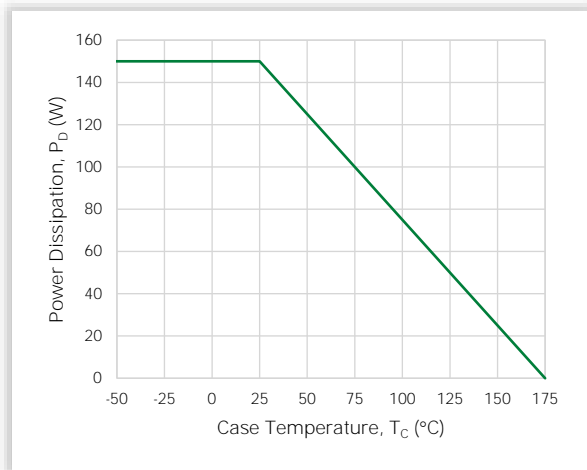

Figure 4. Current Derating (Per Leg)

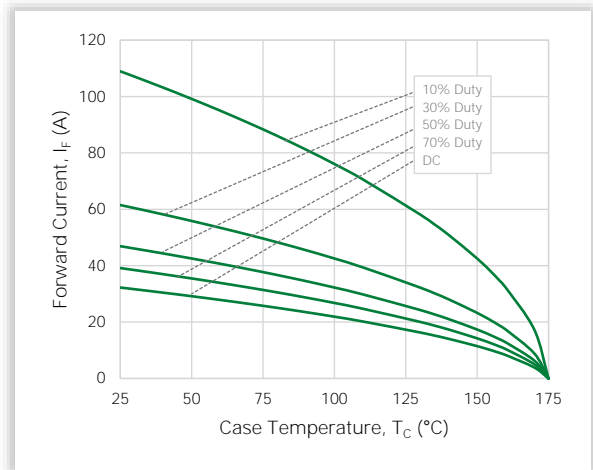

Figure 5. Capacitance vs. Reverse Voltage (Per Leg)

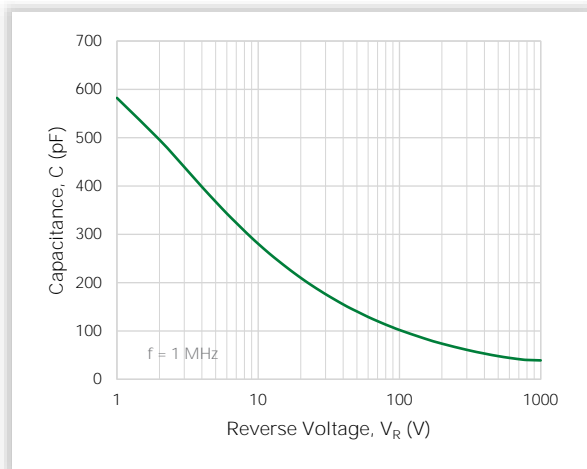

Figure 6. Capacitive Charge vs. Reverse Voltage (Per Leg)

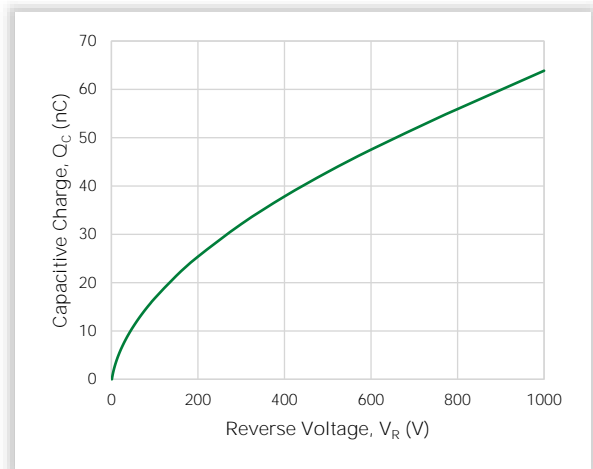

Figure 7. Stored Energy vs. Reverse Voltage (Per Leg)

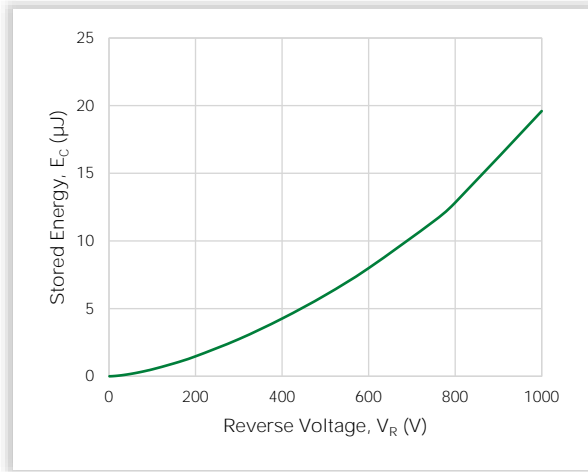
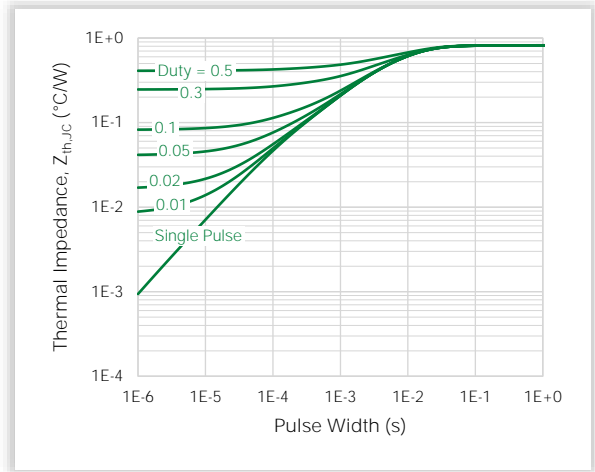
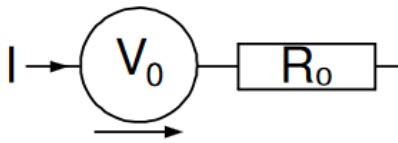

Figure 8. Transient Thermal Impedance (Per Leg)



### 5. Diode V<sub>F</sub> Model for Simulation



$$V_F(T_J) = V_0 + IR_0$$

$$V_0 = -1.11 \times 10^{-3} \cdot T_J + 1.01 \times 10^0$$

$$R_0 = 1.61 \times 10^{-6} \cdot T_J^2 + 1.50 \times 10^{-4} \cdot T_J + 4.35 \times 10^{-2}$$

Notes:

- T<sub>J</sub> is junction temperature in °C
- Range valid from 25 °C to 175 °C
- Model represents performance of a typical part

### 6. Package Dimensions

TO-247-3L Package

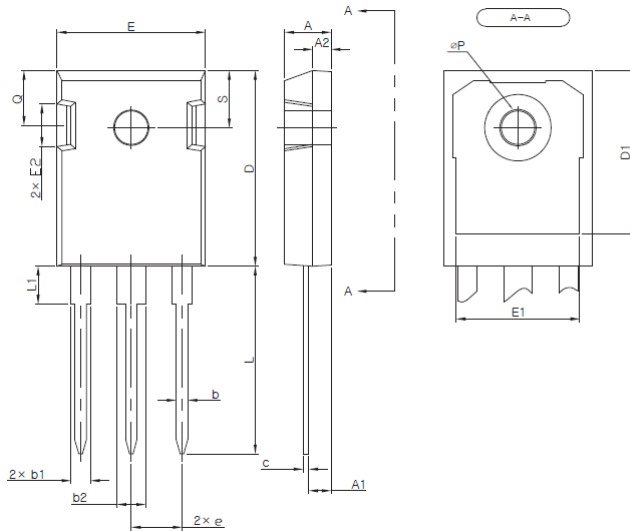

Recommended Hole Pattern Layout

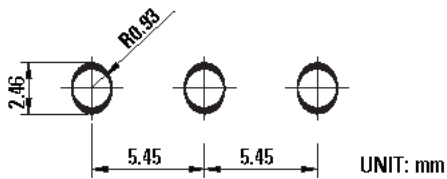

Symbol	Millimeters		
	Min	Nom	Max
A	4.80	5.00	5.20
A1	2.29	2.41	2.54
A2	1.90	2.00	2.10
b	1.10	1.20	1.30
b1	1.91	2.10	2.20
b2	2.92	3.10	3.20
c	0.50	0.60	0.70
D	20.80	21.07	21.34
D1	17.43	17.63	17.83
E	15.75	15.94	16.13
E1	13.06	13.26	13.46
E2	4.32	4.58	4.83
e	5.45 BSC		
L	19.81	20.19	20.57
L1	3.81	4.07	4.32
øP	3.55	3.60	3.65
Q	5.59	5.90	6.20
S	6.15 BSC		

Note: These dimensions do not include mold protrusions

### 7. Part Numbering and Marking

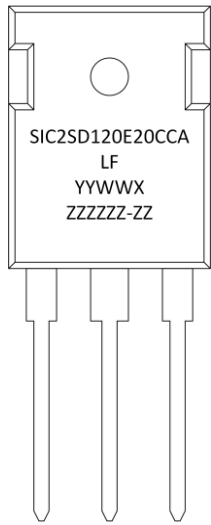

- Sic = Sic Diode
- 2 = Gen2
- SD = Schottky Diode
- 120 = Voltage Rating (1200 V)
- E = TO-247-3L
- 20 = Current Rating (20 A)
- CC = Common Cathode
- A = AEC-Q101 Qualified
- YY = Year
- WW = Week
- X = Special Code
- ZZZZZZ-ZZ = Lot Number

### 8. Packing Options

Part Number	Marking	Packing Mode	M.O.Q.
LSIC2SD120E20CCA	SIC2SD120E20CCA	Tube (30 pcs)	450

### 9. Packing Specifications

Tube for TO-247-3L

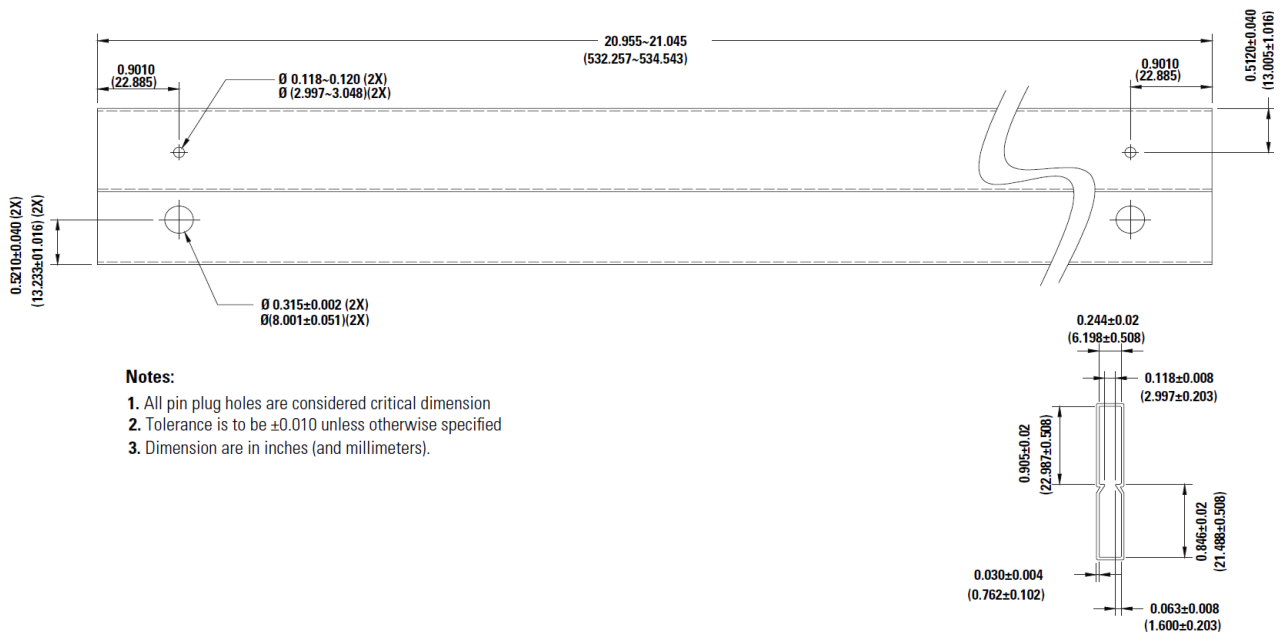

For additional information please visit [www.Littelfuse.com/powersemi](http://www.Littelfuse.com/powersemi)

Disclaimer Notice - Littelfuse products are not designed for, and shall not be used for, any purpose (including, without limitation, automotive, military, aerospace, medical, life-saving, life-sustaining or nuclear facility applications, devices intended for surgical implant into the body, or any other application in which the failure or lack of desired operation of the product may result in personal injury, death, or property damage) other than those expressly forth in applicable Littelfuse product documentation. Littelfuse shall not be liable for any claims or damages arising out of products used in applications not expressly intended by Littelfuse as set forth in applicable Littelfuse documentation.

Read complete Disclaimer Notice at [www.littelfuse.com/disclaimer-electronics](http://www.littelfuse.com/disclaimer-electronics)