

LSIC2SD120C05A 1200 V, 5 A SiC Schottky Barrier Diode

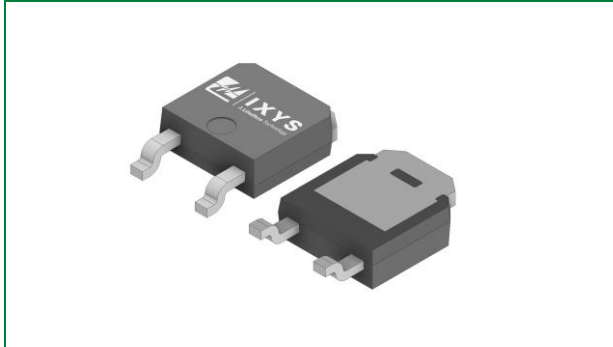

Agency Approvals and Environmental

Environmental Approvals



Pinout Diagram

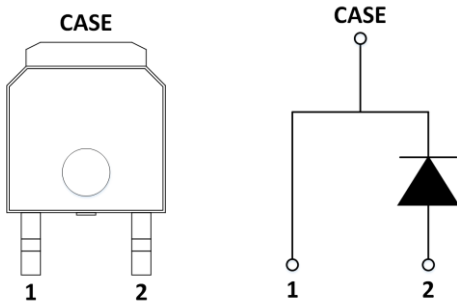

Product Summary

Characteristic	Value	Unit
V_{RRM}	1200	V
$I_F (T_C \leq 135^\circ\text{C})$	8.7	A
$Q_C (V_R: 0-800\text{ V})$	31	nC

Features

- AEC-Q101 Qualified
- MSL 1 Rated
- Positive temperature coefficient for safe operation and ease of paralleling
- 175 °C maximum operating junction temperature
- Excellent surge capability
- Extremely fast, temperature-independent switching behavior
- Dramatically reduced switching losses compared to Si bipolar diodes
- RoHS compliant, lead-free, and halogen-free

Applications

- Boost diodes in PFC or DC/DC stages
- Switch-mode power supplies
- Solar inverters
- Uninterruptable power supplies
- Industrial motor drives
- Battery Chargers
- High speed rectifier

- 1. Maximum Ratings.....3
- 2. Thermal Characteristics3
- 3. Electrical Characteristics3
- 4. Performance Curves4
- 5. V_F Model for Simulation5
- 6. Package Dimensions6
- 7. Part Numbering and Marking.....6
- 8. Packing Options6
- 9. Packing Specifications7

1. Maximum Ratings

Characteristic	Symbol	Conditions	Value	Unit
Repetitive Peak Reverse Voltage	V_{RRM}	-	1200	V
DC Blocking Voltage	V_R	-	1200	V
Continuous Forward Current	I_F	$T_C = 25\text{ °C}$	18.0	A
		$T_C = 135\text{ °C}$	8.7	
		$T_C = 159\text{ °C}$	5	
Non-repetitive Forward Surge Current	I_{FSM}	$T_C = 25\text{ °C}$, $t_p = 10\text{ ms}$, Half sine pulse	40	A
I^2t	$\int I^2 dt$	$T_C = 25\text{ °C}$, $t_p = 10\text{ ms}$, Half sine pulse	8	A ² s
Power Dissipation	P_{Tot}	$T_C = 25\text{ °C}$	100	W
		$T_C = 110\text{ °C}$	43	
Operating Junction Temperature	T_J	-	-55 to 175	°C
Storage Temperature	T_{STG}	-	-55 to 150	°C
Lead Temperature for Soldering (MSL 1 Rated)	T_{SOLD}	-	260	°C

2. Thermal Characteristics

Characteristic	Symbol	Value	Unit
Maximum Thermal Resistance, junction-to-case	$R_{thJC,MAX}$	1.5	°C/W

3. Electrical Characteristics

Characteristic	Symbol	Conditions	Value			Unit
			Min	Typ	Max	
Forward Voltage	V_F	$I_F = 5\text{ A}$, $T_J = 25\text{ °C}$	-	1.5	1.8	V
		$I_F = 5\text{ A}$, $T_J = 175\text{ °C}$	-	2.1	-	
Reverse Current	I_R	$V_R = 1200\text{ V}$, $T_J = 25\text{ °C}$	-	<1	100	μA
		$V_R = 1200\text{ V}$, $T_J = 175\text{ °C}$	-	2	-	
Total Capacitance	C	$V_R = 1\text{ V}$, $f = 1\text{ MHz}$	-	310	-	pF
		$V_R = 400\text{ V}$, $f = 1\text{ MHz}$	-	29	-	
		$V_R = 800\text{ V}$, $f = 1\text{ MHz}$	-	22	-	
Total Capacitive Charge	Q_C	$V_R = 800\text{ V}$, $Q_C = \int Q(V) dV$	-	31	-	nC
Capacitive Stored Energy	E_C	$V_R = 800\text{ V}$	-	6.9	-	μJ

4. Performance Curves

Figure 1. Typical Forward Characteristics

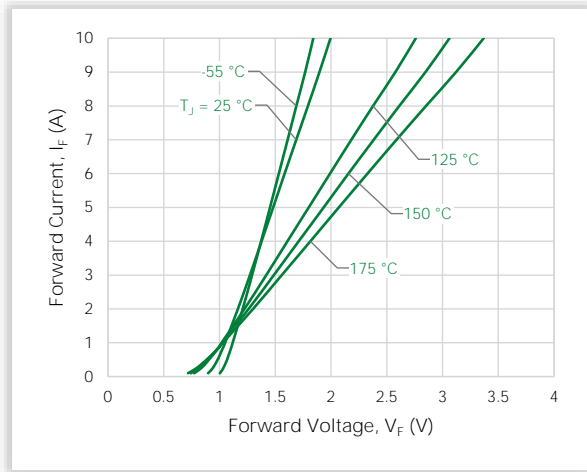

Figure 2. Typical Reverse Characteristics

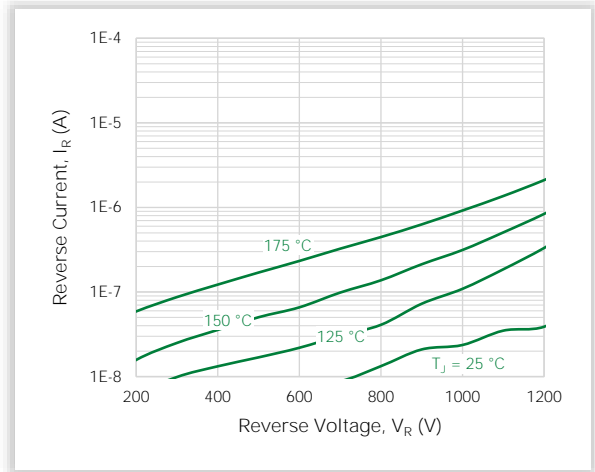

Figure 3. Power Derating

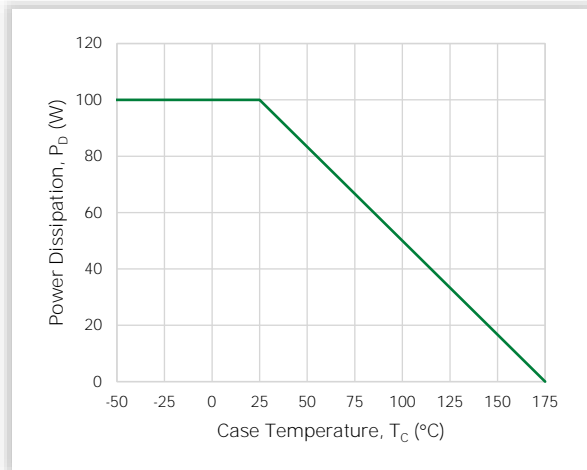

Figure 4. Current Derating

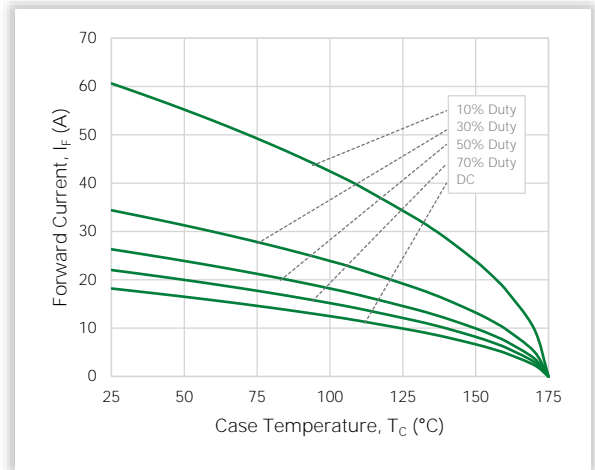

Figure 5. Capacitance vs. Reverse Voltage

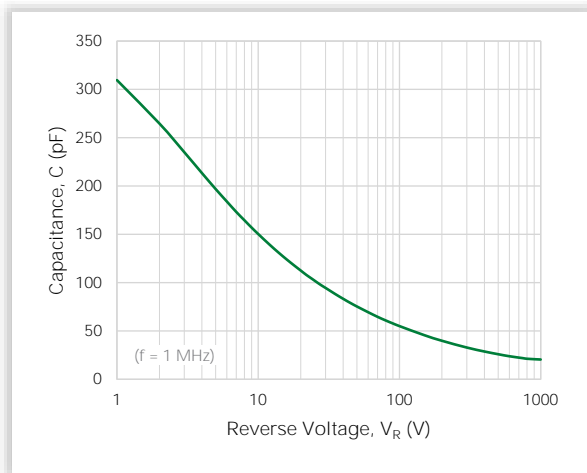

Figure 6. Capacitive Charge vs. Reverse Voltage

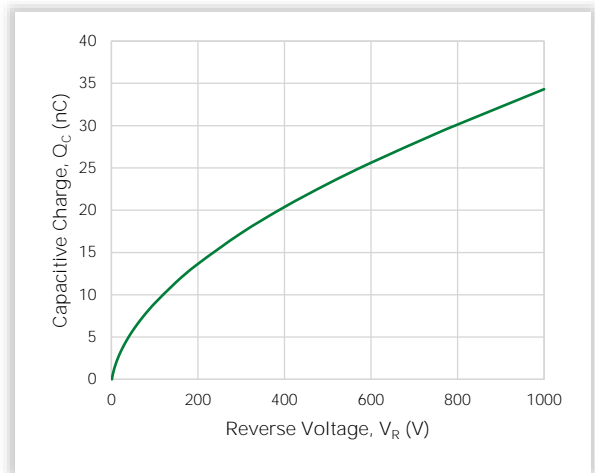

Figure 7. Stored Energy vs. Reverse Voltage

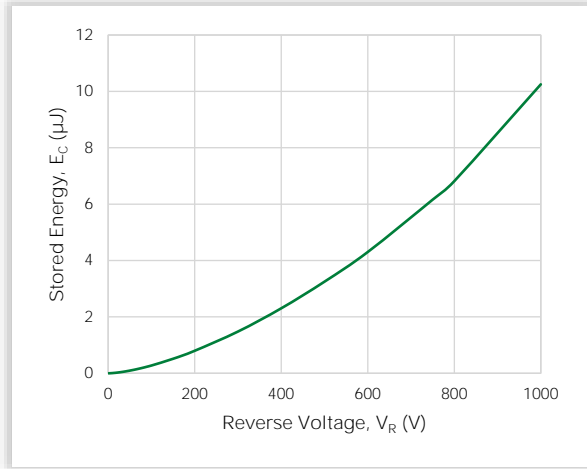
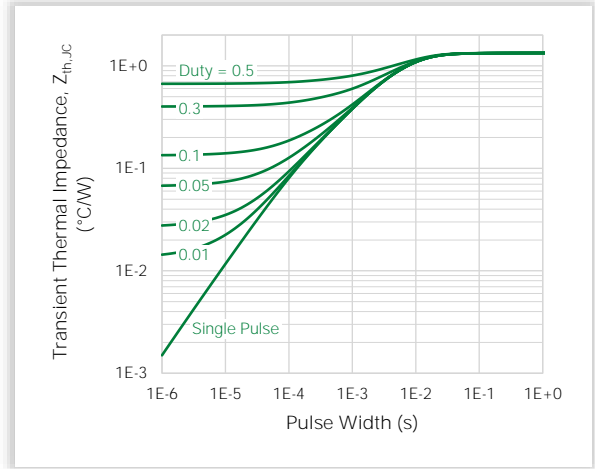
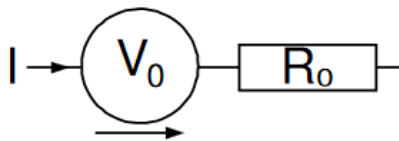

Figure 8. Transient Thermal Impedance



5. V_F Model for Simulation



$$V_F(T_J) = V_0 + IR_0$$

$$V_0 = -1.24 \times 10^{-3} \cdot T_J + 9.94 \times 10^{-1}$$

$$R_0 = 2.92 \times 10^{-6} \cdot T_J^2 + 4.58 \times 10^{-4} \cdot T_J + 9.01 \times 10^{-2}$$

Notes:

- T_J is junction temperature in °C
- Range valid from 25 °C to 175 °C
- Model represents performance of a typical part

6. Package Dimensions

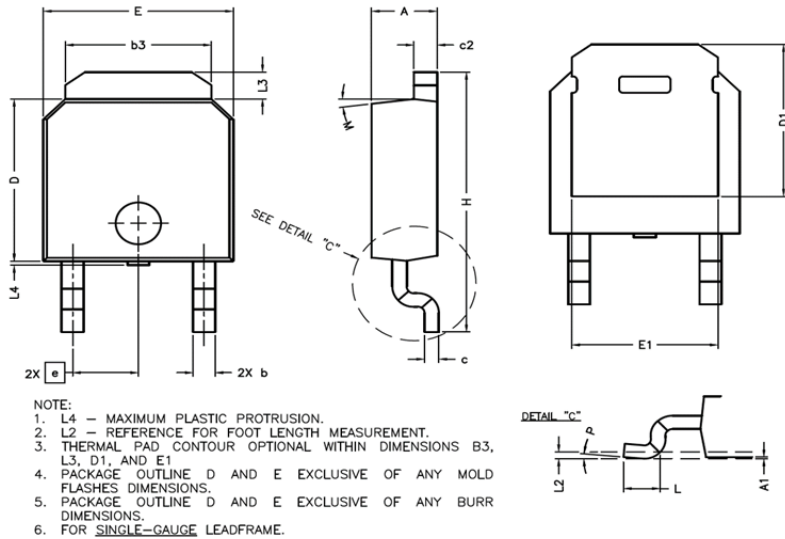

Symbol	Millimeters	
	Min	Max
A	2.159	2.413
A1	-	0.127
b	0.635	1.067
b3	4.953	5.461
c	0.457	0.610
c2	-	0.889
(c2)	0.457	0.610
D	5.969	6.223
D1	5.207	5.715
E	6.350	6.731
E1	4.318	5.207
e	2.29 REF.	
H	9.398	10.414
L	1.016	1.778
L2	0.25 REF.	
L3	0.889	1.270
L4	0.000	0.152
M	15°	
P	-	5°

Recommended Solder Pad Layout

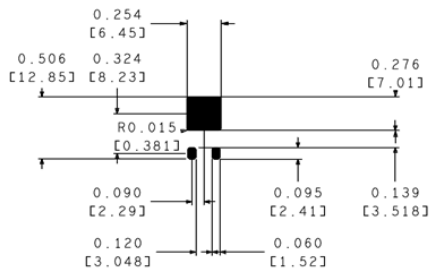

UNIT: Inch [mm]

7. Part Numbering and Marking

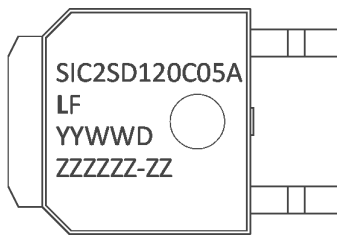

- SIC = SiC
- 2 = Gen 2
- SD = Schottky Barrier Diode
- 120 = Voltage Rating (1200 V)
- C = Package (TO-252-2L)
- 05 = Current Rating (5 A)
- A = AEC-Q101 qualified
- YY = Year
- WW = Week
- D = Special Code
- ZZZZZZ-ZZ = Lot Number

8. Packing Options

Part Number	Marking	Packing Mode	M.O.Q.
LSIC2SD120C05A	SIC2SD120C05A	Tape & Reel	2500

9. Packing Specifications

TO-252 Carrier Tape & Reel Specifications

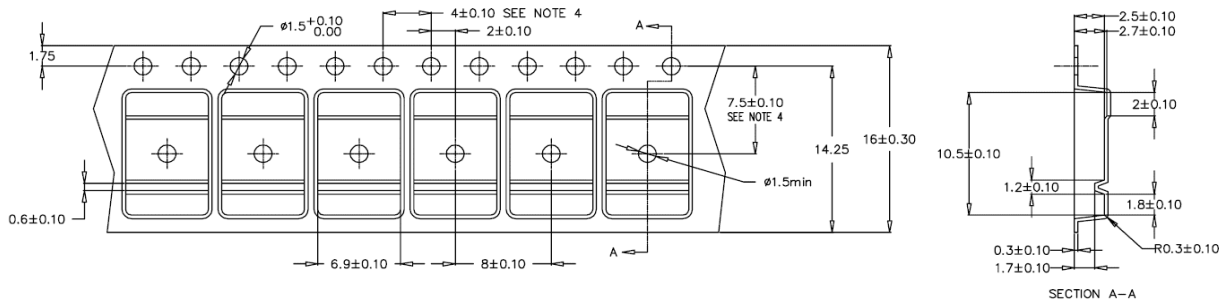

1. Material: Black Conductive Polyesterene
2. 10 sprocket hole pitch cumulative tolerance ± 0.20
3. Camber not to exceed 1 mm in 100 mm.
4. Pocket position relative to sprocket hole measured as true position of pocket, not pocket hole.
5. Device orientation: TRL (leads perpendicular to the sprocket)
6. General tolerance is ± 0.10 mm unless otherwise specified.

COVER TAPE SPECS:

- Width : 13.5 mm
- Base Material : less than 1.2×10^{10} ohms/square
Transparent polyester, static dissipative
- Adhesive Layer : Polyethylene
- Total Thickness : 60 Micron
- Tensile Strength : 4-6 kg/mm²
- Elongation : 91%
- Tearing Strength : 11 kg/mm²
- Shelf life : 2 years

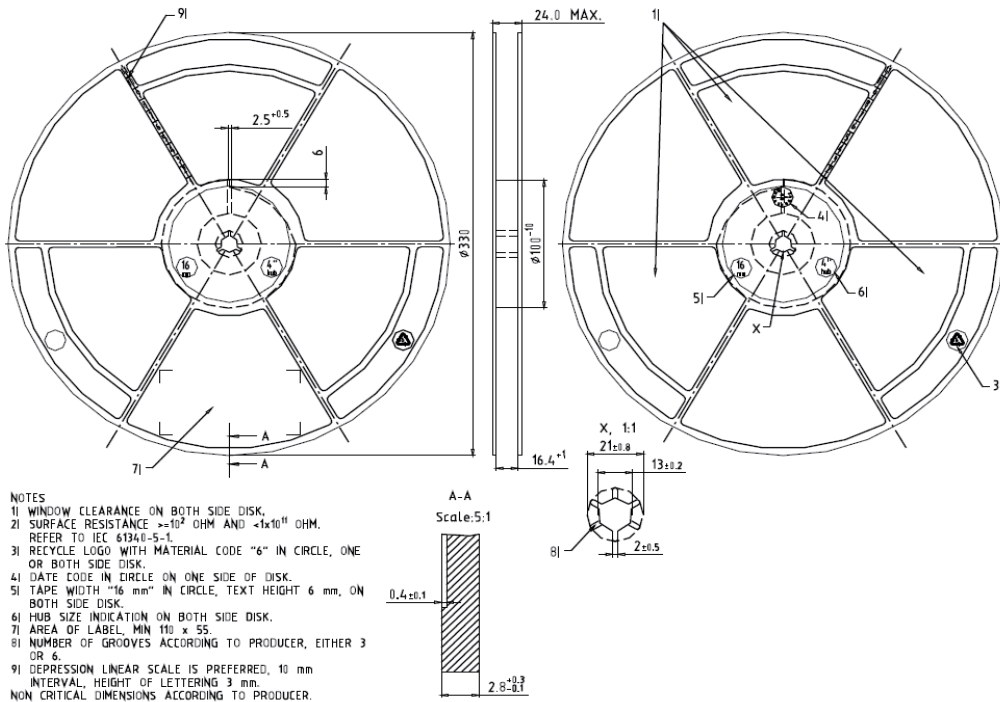

- NOTES**
- 1) WINDOW CLEARANCE ON BOTH SIDE DISK.
 - 2) SURFACE RESISTANCE $\leq 10^9$ OHM AND $\leq 1 \times 10^{11}$ OHM. REFER TO IEC 61340-5-1.
 - 3) RECYCLE LOGO WITH MATERIAL CODE "6" IN CIRCLE, ONE OR BOTH SIDE DISK.
 - 4) DATE CODE IN CIRCLE ON ONE SIDE OF DISK.
 - 5) TAPE WIDTH "16 mm" IN CIRCLE, TEXT HEIGHT 6 mm, ON BOTH SIDE DISK.
 - 6) HUB SIZE INDICATION ON BOTH SIDE DISK.
 - 7) AREA OF LABEL, MIN 110 x 55.
 - 8) NUMBER OF GROOVES ACCORDING TO PRODUCER, EITHER 3 OR 6.
 - 9) DEPRESSION LINEAR SCALE IS PREFERRED, 10 mm INTERVAL, HEIGHT OF LETTERING 3 mm. NON CRITICAL DIMENSIONS ACCORDING TO PRODUCER.

For additional information please visit www.Littelfuse.com/powersemi

Disclaimer Notice - Littelfuse products are not designed for, and shall not be used for, any purpose (including, without limitation, automotive, military, aerospace, medical, life-saving, life-sustaining or nuclear facility applications, devices intended for surgical implant into the body, or any other application in which the failure or lack of desired operation of the product may result in personal injury, death, or property damage) other than those expressly forth in applicable Littelfuse product documentation. Littelfuse shall not be liable for any claims or damages arising out of products used in applications not expressly intended by Littelfuse as set forth in applicable Littelfuse documentation.

Read complete Disclaimer Notice at www.littelfuse.com/disclaimer-electronics