

DUR6060W

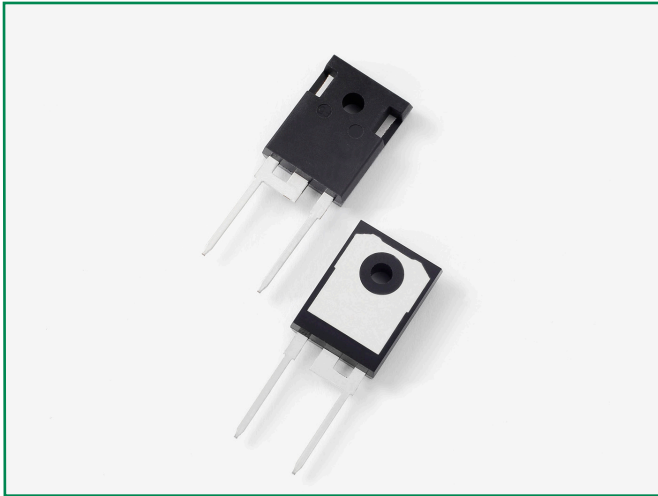

Description

Littelfuse DUR series Ultrafast Recovery Rectifier is designed to meet the general requirements of commercial applications by providing low T_{rr} , high-temperature, low-leakage and low forward voltage drop products. It is suitable for output rectifier, free-wheeling or boost diode in high-frequency power switching application such as switch mode power supply and DC-DC converters.

Features

- Ultra-fast switching
- Low reverse leakage current
- High surge current capability
- Low forward voltage drop
- Single die in two-lead TO-247AC package
- Pb-free E3 means 2nd level interconnect is Pb-free and the terminal finish material is tin(Sn) (IPC/ JEDEC J-STD-609A.01)

Circuit Diagram

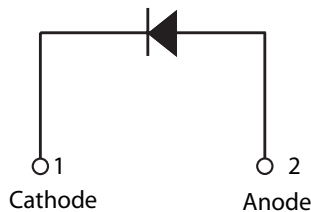

Applications

- Output rectifiers in switch mode power supplies (SMPS) and DC to DC converters
- Free-wheeling diode or boost diode in converters and motor control circuits
- Anti-parallel diode for high frequency switching devices such as IGBT
- Uninterruptible Power Supplies (UPS)
- Inductive heating and melting
- Ultrasonic cleaners and welders

Maximum Ratings

Characteristics	Symbol	Conditions	Max.	Unit
Peak Inverse Voltage	V_{RWM}	-	600	V
Average Rectifier Forward Current	$I_{F(AV)}$	Rated V_r , @ $T_c = 70^\circ\text{C}$,	60	A
Peak One Cycle Non-Repetitive Surge Current	I_{FSM}	8.3 ms, half sine pulse	600	A

Electrical Characteristics

Characteristics	Symbol	Conditions	Max.	Unit
Forward Voltage Drop ¹	V_{F1}	@60A, Pulse, $T_j = 25^\circ\text{C}$	2.0	V
Reverse Current ¹	I_{R1}	@ $V_r = \text{Rated } V_r$, $T_j = 25^\circ\text{C}$	100	μA
	I_{R2}	@ $V_r = \text{Rated } V_r$, $T_j = 125^\circ\text{C}$	14	mA
Reverse Recovery Time	t_{rr1}	$I_F = 500\text{mA}$, $I_R = 1\text{A}$, and $I_{rm} = 250\text{mA}$	50	ns

Footnote ¹: Pulse Width < 300 μs , Duty Cycle < 2%

Thermal-Mechanical Specifications

Characteristics	Symbol	Conditions	Specification	Unit
Junction Temperature	T_J	-	-55 to +150	°C
Storage Temperature	T_{stg}	-	-55 to +150	°C
Typical Thermal Resistance Junction to Case	$R_{\theta JC}$	DC operation	0.75	°C/W
Approximate Weight	wt	-	6.7	g
Case Style	-	TO-247AC	-	-

Figure 1: Typical Forward Characteristics

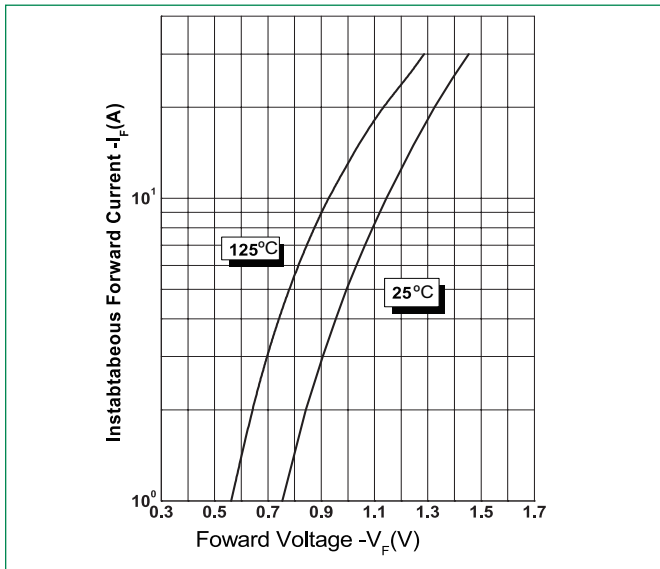

Figure 2: Typical Reverse Characteristics

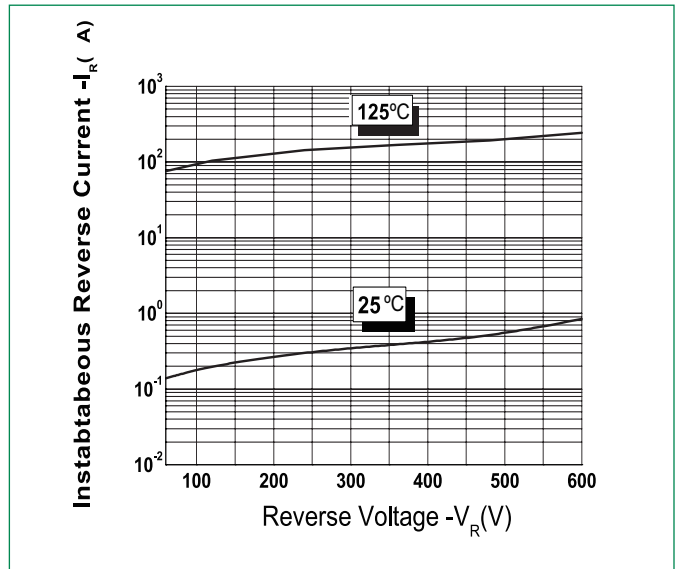
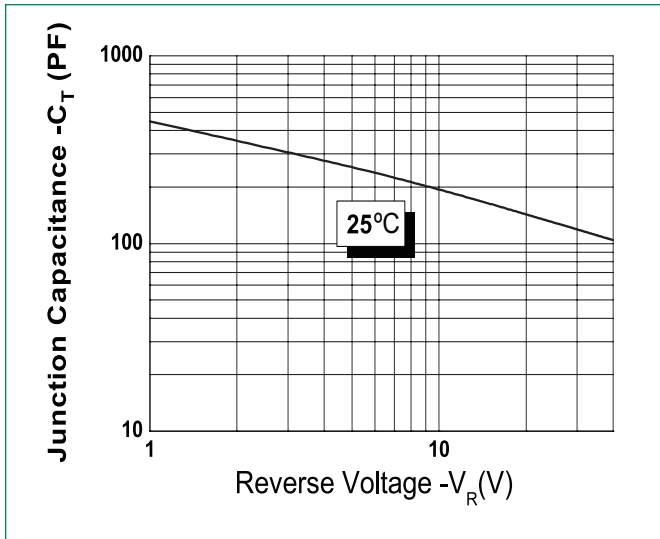
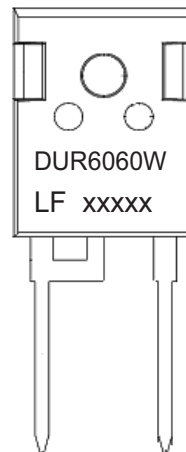

Figure 3: Typical Junction Capacitance



Part Numbering and Marking System



Where XXXXX is YYWWL

- DUR = Device Type
- 60 = Forward Current (60A)
- 60 = Reverse Voltage (600V)
- W = Configuration
- LF = Littelfuse
- YY = Year
- WW = Week
- L = Lot Number

Packing Options

Part Number	Marking	Packing Mode	M.O.Q
DUR6060W	DUR6060W	30 pcs/Tube	300

Dimensions-Package TO-247AC

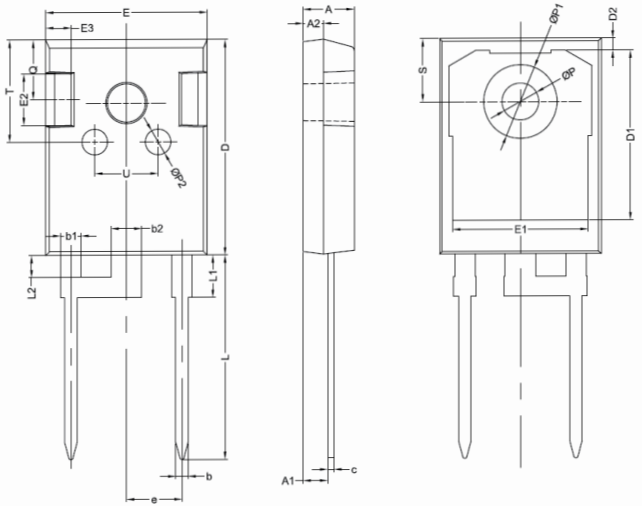

Symbol	Millimeters		
	Min	Typ	Max
A	4.80	5.00	5.20
A1	2.21	2.41	2.61
A2	1.90	2.00	2.10
b	1.10	1.20	1.35
b1	-	2.00	-
b2	-	3.00	-
c	0.55	0.60	0.75
D	20.80	21.00	21.20
D1	-	16.55	-
D2	-	1.20	-
E	15.60	15.80	16.00
E1	-	13.30	-
E2	-	5.00	-
E3	-	2.50	-
e	-	5.44	-
L	19.42	19.92	20.42
L1	-	4.13	-
L2	-	2.15	-
P	3.50	3.60	3.70
P1	-	-	7.40
P2	-	2.50	-
Q	-	5.80	-
S	6.05	6.15	6.25
T	-	10.00	-
U	-	6.20	-

Tube Specification TO-247AC

