

# High Efficiency Thyristor

$$V_{RRM} = 2 \times 1200 \text{ V}$$

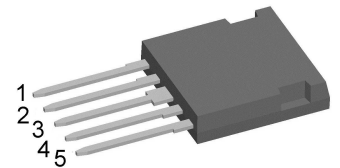
$$I_{TAV} = 40 \text{ A}$$

$$V_T = 1.19 \text{ V}$$

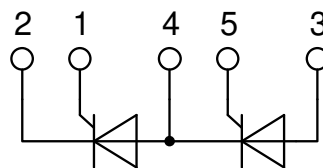
Phase leg

Part number

**CLA40P1200FC**



Backside: isolated



### Features / Advantages:

- Thyristor for line frequency
- Planar passivated chip
- Long-term stability

### Applications:

- Line rectifying 50/60 Hz
- Softstart AC motor control
- DC Motor control
- Power converter
- AC power control
- Lighting and temperature control

### Package: i4-Pac

- Isolation Voltage: 3000 V~
- Industry convenient outline
- RoHS compliant
- Epoxy meets UL 94V-0
- Soldering pins for PCB mounting
- Backside: DCB ceramic
- Reduced weight
- Advanced power cycling

### Disclaimer Notice

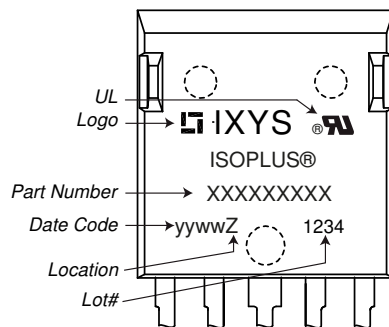
Information furnished is believed to be accurate and reliable. However, users should independently evaluate the suitability of and test each product selected for their own applications. Littelfuse products are not designed for, and may not be used in, all applications. Read complete Disclaimer Notice at [www.littelfuse.com/disclaimer-electronics](http://www.littelfuse.com/disclaimer-electronics).



Thyristor			Ratings			
Symbol	Definition	Conditions	min.	typ.	max.	Unit
$V_{RSM/DSM}$	max. non-repetitive reverse/forward blocking voltage	$T_{VJ} = 25^{\circ}C$			1300	V
$V_{RRM/DRM}$	max. repetitive reverse/forward blocking voltage	$T_{VJ} = 25^{\circ}C$			1200	V
$I_{RD}$	reverse current, drain current	$V_{R/D} = 1200 V$	$T_{VJ} = 25^{\circ}C$		50	$\mu A$
		$V_{R/D} = 1200 V$	$T_{VJ} = 125^{\circ}C$		4	mA
$V_T$	forward voltage drop	$I_T = 40 A$	$T_{VJ} = 25^{\circ}C$		1.25	V
		$I_T = 80 A$			1.49	V
		$I_T = 40 A$	$T_{VJ} = 125^{\circ}C$		1.19	V
		$I_T = 80 A$			1.50	V
$I_{TAV}$	average forward current	$T_C = 95^{\circ}C$	$T_{VJ} = 150^{\circ}C$		40	A
$I_{T(RMS)}$	RMS forward current	180° sine			63	A
$V_{T0}$	threshold voltage	} for power loss calculation only	$T_{VJ} = 150^{\circ}C$		0.86	V
$r_T$	slope resistance				7.9	m $\Omega$
$R_{thJC}$	thermal resistance junction to case				0.8	K/W
$R_{thCH}$	thermal resistance case to heatsink			0.2		K/W
$P_{tot}$	total power dissipation		$T_C = 25^{\circ}C$		150	W
$I_{TSM}$	max. forward surge current	$t = 10 \text{ ms}; (50 \text{ Hz}), \text{ sine}$	$T_{VJ} = 45^{\circ}C$		650	A
		$t = 8,3 \text{ ms}; (60 \text{ Hz}), \text{ sine}$	$V_R = 0 V$		700	A
		$t = 10 \text{ ms}; (50 \text{ Hz}), \text{ sine}$	$T_{VJ} = 150^{\circ}C$		555	A
		$t = 8,3 \text{ ms}; (60 \text{ Hz}), \text{ sine}$	$V_R = 0 V$		595	A
$I^2t$	value for fusing	$t = 10 \text{ ms}; (50 \text{ Hz}), \text{ sine}$	$T_{VJ} = 45^{\circ}C$		2.12	kA <sup>2</sup> s
		$t = 8,3 \text{ ms}; (60 \text{ Hz}), \text{ sine}$	$V_R = 0 V$		2.04	kA <sup>2</sup> s
		$t = 10 \text{ ms}; (50 \text{ Hz}), \text{ sine}$	$T_{VJ} = 150^{\circ}C$		1.54	kA <sup>2</sup> s
		$t = 8,3 \text{ ms}; (60 \text{ Hz}), \text{ sine}$	$V_R = 0 V$		1.48	kA <sup>2</sup> s
$C_J$	junction capacitance	$V_R = 400 V \quad f = 1 \text{ MHz}$	$T_{VJ} = 25^{\circ}C$		25	pF
$P_{GM}$	max. gate power dissipation	$t_p = 30 \mu s$	$T_C = 150^{\circ}C$		10	W
		$t_p = 300 \mu s$			5	W
$P_{GAV}$	average gate power dissipation				0.5	W
$(di/dt)_{cr}$	critical rate of rise of current	$T_{VJ} = 150^{\circ}C; f = 50 \text{ Hz}$	repetitive, $I_T = 120 A$		150	A/ $\mu s$
		$t_p = 200 \mu s; di_G/dt = 0.3 A/\mu s;$	non-repet., $I_T = 40 A$		500	A/ $\mu s$
$(dv/dt)_{cr}$	critical rate of rise of voltage	$V = \frac{2}{3} V_{DRM}$	$T_{VJ} = 150^{\circ}C$		1000	V/ $\mu s$
		$R_{GK} = \infty; \text{method 1 (linear voltage rise)}$				
$V_{GT}$	gate trigger voltage	$V_D = 6 V$	$T_{VJ} = 25^{\circ}C$		1.5	V
			$T_{VJ} = -40^{\circ}C$		1.6	V
$I_{GT}$	gate trigger current	$V_D = 6 V$	$T_{VJ} = 25^{\circ}C$		50	mA
			$T_{VJ} = -40^{\circ}C$		80	mA
$V_{GD}$	gate non-trigger voltage	$V_D = \frac{2}{3} V_{DRM}$	$T_{VJ} = 150^{\circ}C$		0.2	V
$I_{GD}$	gate non-trigger current				3	mA
$I_L$	latching current	$t_p = 10 \mu s$	$T_{VJ} = 25^{\circ}C$		125	mA
		$I_G = 0.3 A; di_G/dt = 0.3 A/\mu s$				
$I_H$	holding current	$V_D = 6 V \quad R_{GK} = \infty$	$T_{VJ} = 25^{\circ}C$		100	mA
$t_{gd}$	gate controlled delay time	$V_D = \frac{1}{2} V_{DRM}$	$T_{VJ} = 25^{\circ}C$		2	$\mu s$
		$I_G = 0.3 A; di_G/dt = 0.3 A/\mu s$				
$t_q$	turn-off time	$V_R = 100 V; I_T = 40 A; V = \frac{2}{3} V_{DRM}$	$T_{VJ} = 125^{\circ}C$		200	$\mu s$
		$di/dt = 10 A/\mu s \quad dv/dt = 20 V/\mu s \quad t_p = 200 \mu s$				

Package i4-Pac		Ratings				
Symbol	Definition	Conditions	min.	typ.	max.	Unit
$I_{RMS}$	RMS current	per terminal			70	A
$T_{VJ}$	virtual junction temperature		-40		150	°C
$T_{op}$	operation temperature		-40		125	°C
$T_{stg}$	storage temperature		-40		150	°C
<b>Weight</b>				6		g
$F_C$	mounting force with clip		20		120	N
$d_{Spp/ App}$	creepage distance on surface / striking distance through air	terminal to terminal	1.7			mm
$d_{Spb/ Apb}$		terminal to backside	5.1			mm
$V_{ISOL}$	isolation voltage	t = 1 second t = 1 minute	3000 2500			V V
		50/60 Hz, RMS; $I_{ISOL} \leq 1$ mA				

### Product Marking



### Part description

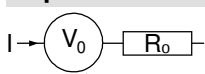
C = Thyristor (SCR)  
 L = High Efficiency Thyristor  
 A = (up to 1200V)  
 40 = Current Rating [A]  
 P = Phase leg  
 1200 = Reverse Voltage [V]  
 FC = i4-Pac (5)

Ordering	Ordering Number	Marking on Product	Delivery Mode	Quantity	Code No.
Standard	CLA40P1200FC	CLA40P1200FC	Tube	25	510210

### Equivalent Circuits for Simulation

\* on die level

$T_{VJ} = 150^{\circ}\text{C}$

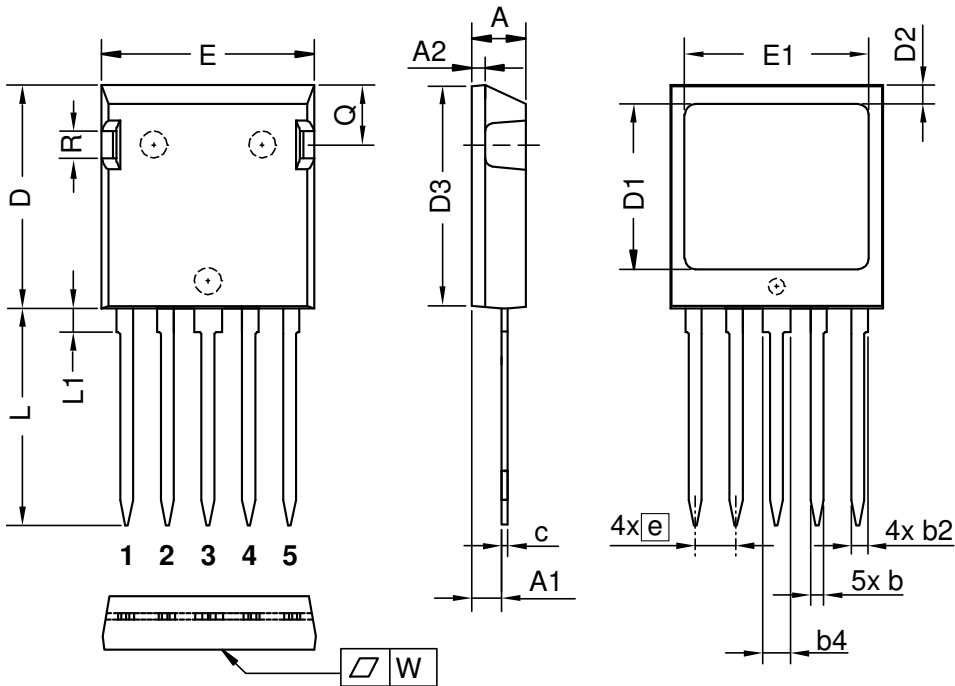


Thyristor

$V_{0\ max}$	threshold voltage	0.86	V
$R_{0\ max}$	slope resistance *	5.4	mΩ

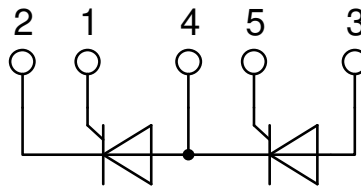


**Outlines i4-Pac**



Dim.	Millimeter		Inches	
	min	max	min	max
A	4.83	5.21	0.190	0.205
A1	2.59	3.00	0.102	0.118
A2	1.17	2.16	0.046	0.085
b	1.14	1.40	0.045	0.055
b2	1.47	1.73	0.058	0.068
b4	2.54	2.79	0.100	0.110
c	0.51	0.74	0.020	0.029
D	20.80	21.34	0.819	0.840
D1	14.99	15.75	0.590	0.620
D2	1.65	2.03	0.065	0.080
D3	20.30	20.70	0.799	0.815
E	19.56	20.29	0.770	0.799
E1	16.76	17.53	0.660	0.690
e	3.81 BSC		0.150 BSC	
L	19.81	21.34	0.780	0.840
L1	2.11	2.59	0.083	0.102
Q	5.33	6.20	0.210	0.244
R	2.54	4.57	0.100	0.180
W	-	0.10	-	0.004

Die konvexe Form des Substrates ist typ. < 0.05 mm über der Kunststoffoberfläche der Bauteilunterseite  
The convexbow of substrate is typ. < 0.05 mm over plastic surface level of device bottom side



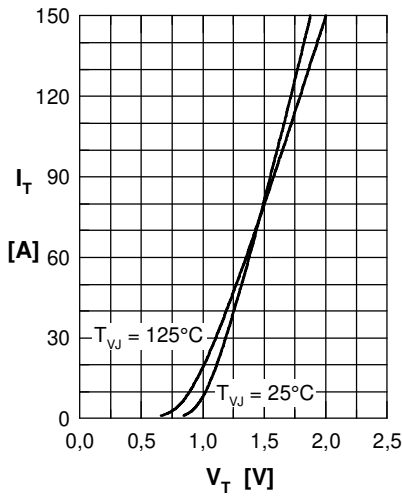
**Thyristor**


Fig. 1 Forward characteristics

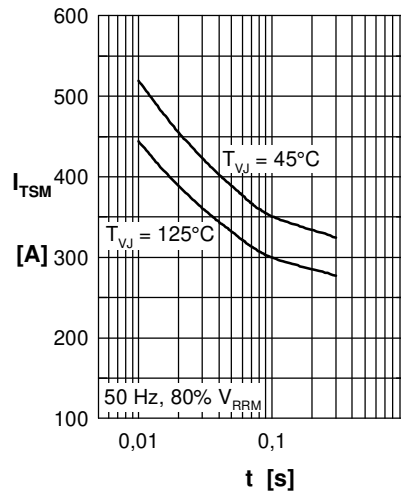
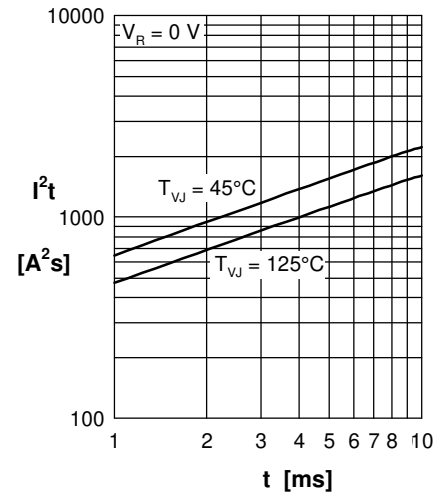
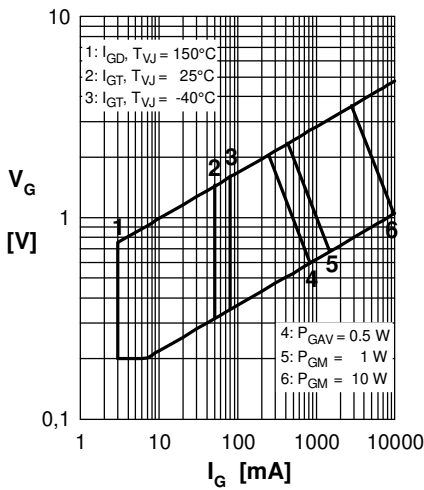

 Fig. 2 Surge overload current  
 $I_{TSM}$ : crest value,  $t$ : duration

 Fig. 3  $I^2t$  versus time (1-10 s)


Fig. 4 Gate voltage &amp; gate current

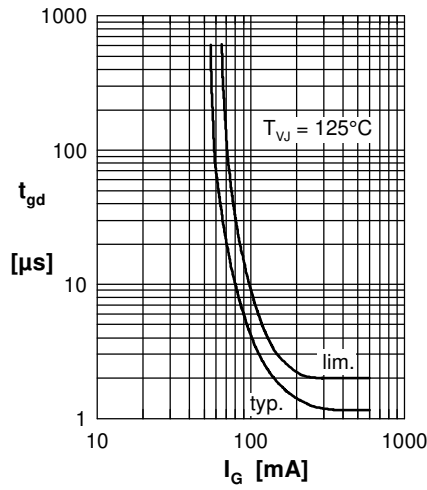
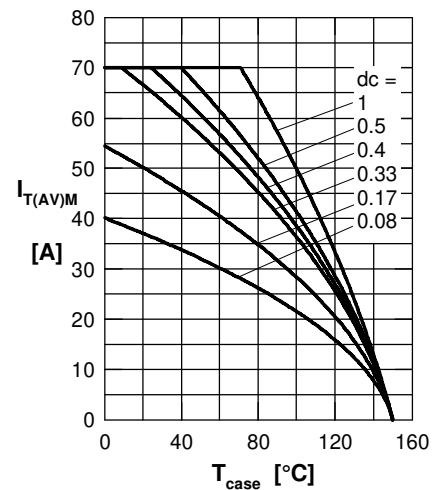

 Fig. 5 Gate controlled delay time  $t_{gd}$ 


Fig. 6 Max. forward current at case temperature

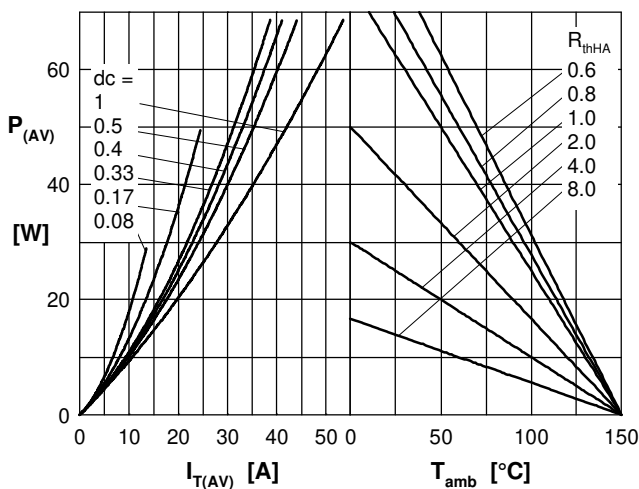
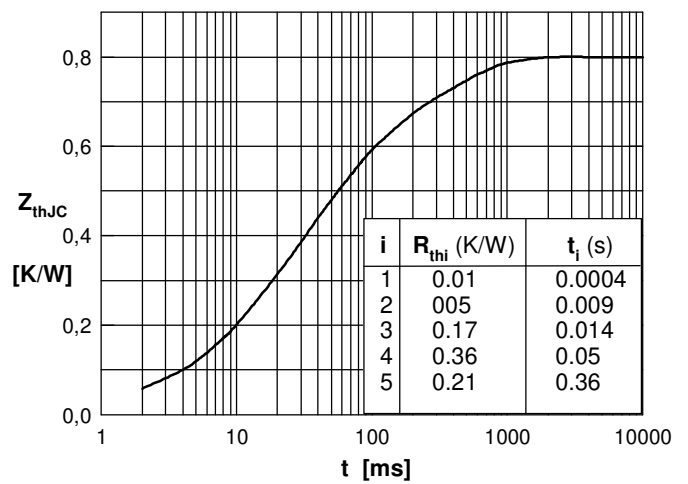

 Fig. 7a Power dissipation versus direct output current  
 Fig. 7b and ambient temperature


Fig. 7 Transient thermal impedance junction to case