



# Thyristor

$$V_{RRM} = 1600\text{ V}$$

$$I_{TAV} = 20\text{ A}$$

$$V_T = 1.48\text{ V}$$

## Single Thyristor

### Part number

**CMA20E1600PZ**

Marking on Product: CMA20E1600PZ

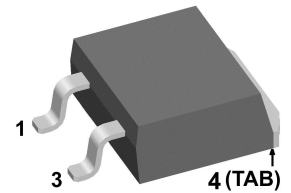

Backside: anode

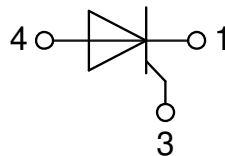

### Features / Advantages:

- Thyristor for line frequency
- Planar passivated chip
- Long-term stability

### Applications:

- Line rectifying 50/60 Hz
- Softstart AC motor control
- DC Motor control
- Power converter
- AC power control
- Lighting and temperature control

### Package: TO-263 (D2Pak-HV)

- Industry standard outline
- RoHS compliant
- Epoxy meets UL 94V-0
- High creepage distance between terminals

### Disclaimer Notice

Information furnished is believed to be accurate and reliable. However, users should independently evaluate the suitability of and test each product selected for their own applications. Littelfuse products are not designed for, and may not be used in, all applications. Read complete Disclaimer Notice at [www.littelfuse.com/disclaimer-electronics](http://www.littelfuse.com/disclaimer-electronics).



Thyristor			Ratings			
Symbol	Definition	Conditions	min.	typ.	max.	Unit
$V_{RSM/DSM}$	max. non-repetitive reverse/forward blocking voltage	$T_{VJ} = 25^{\circ}C$			1700	V
$V_{RRM/DRM}$	max. repetitive reverse/forward blocking voltage	$T_{VJ} = 25^{\circ}C$			1600	V
$I_{RD}$	reverse current, drain current	$V_{R/D} = 1600 V$	$T_{VJ} = 25^{\circ}C$		10	$\mu A$
		$V_{R/D} = 1600 V$	$T_{VJ} = 125^{\circ}C$		2	mA
$V_T$	forward voltage drop	$I_T = 20 A$	$T_{VJ} = 25^{\circ}C$		1.46	V
		$I_T = 40 A$			1.88	V
		$I_T = 20 A$	$T_{VJ} = 125^{\circ}C$		1.48	V
		$I_T = 40 A$			2.02	V
$I_{TAV}$	average forward current	$T_C = 115^{\circ}C$	$T_{VJ} = 150^{\circ}C$		20	A
$I_{T(RMS)}$	RMS forward current	180° sine			31	A
$V_{T0}$	threshold voltage	} for power loss calculation only	$T_{VJ} = 150^{\circ}C$		0.92	V
$r_T$	slope resistance				28	m $\Omega$
$R_{thJC}$	thermal resistance junction to case				0.7	K/W
$R_{thCH}$	thermal resistance case to heatsink			0.25		K/W
$P_{tot}$	total power dissipation		$T_C = 25^{\circ}C$		170	W
$I_{TSM}$	max. forward surge current	$t = 10 \text{ ms}; (50 \text{ Hz}), \text{ sine}$	$T_{VJ} = 45^{\circ}C$		180	A
		$t = 8,3 \text{ ms}; (60 \text{ Hz}), \text{ sine}$	$V_R = 0 V$		195	A
		$t = 10 \text{ ms}; (50 \text{ Hz}), \text{ sine}$	$T_{VJ} = 150^{\circ}C$		155	A
		$t = 8,3 \text{ ms}; (60 \text{ Hz}), \text{ sine}$	$V_R = 0 V$		165	A
$I^2t$	value for fusing	$t = 10 \text{ ms}; (50 \text{ Hz}), \text{ sine}$	$T_{VJ} = 45^{\circ}C$		160	A <sup>2</sup> s
		$t = 8,3 \text{ ms}; (60 \text{ Hz}), \text{ sine}$	$V_R = 0 V$		160	A <sup>2</sup> s
		$t = 10 \text{ ms}; (50 \text{ Hz}), \text{ sine}$	$T_{VJ} = 150^{\circ}C$		120	A <sup>2</sup> s
		$t = 8,3 \text{ ms}; (60 \text{ Hz}), \text{ sine}$	$V_R = 0 V$		115	A <sup>2</sup> s
$C_J$	junction capacitance	$V_R = 400 V \quad f = 1 \text{ MHz}$	$T_{VJ} = 25^{\circ}C$		9	pF
$P_{GM}$	max. gate power dissipation	$t_p = 30 \mu s$	$T_C = 150^{\circ}C$		10	W
		$t_p = 300 \mu s$			5	W
$P_{GAV}$	average gate power dissipation				0.5	W
$(di/dt)_{cr}$	critical rate of rise of current	$T_{VJ} = 125^{\circ}C; f = 50 \text{ Hz}$	repetitive, $I_T = 60 A$		150	A/ $\mu s$
		$t_p = 200 \mu s; di_G/dt = 0.2 A/\mu s;$ $I_G = 0.2 A; V = \frac{2}{3} V_{DRM}$	non-repet., $I_T = 20 A$		500	A/ $\mu s$
$(dv/dt)_{cr}$	critical rate of rise of voltage	$V = \frac{2}{3} V_{DRM}$	$T_{VJ} = 125^{\circ}C$		500	V/ $\mu s$
		$R_{GK} = \infty; \text{method 1 (linear voltage rise)}$				
$V_{GT}$	gate trigger voltage	$V_D = 6 V$	$T_{VJ} = 25^{\circ}C$		1.3	V
			$T_{VJ} = -40^{\circ}C$		1.6	V
$I_{GT}$	gate trigger current	$V_D = 6 V$	$T_{VJ} = 25^{\circ}C$		28	mA
			$T_{VJ} = -40^{\circ}C$		50	mA
$V_{GD}$	gate non-trigger voltage	$V_D = \frac{2}{3} V_{DRM}$	$T_{VJ} = 150^{\circ}C$		0.2	V
$I_{GD}$	gate non-trigger current				1	mA
$I_L$	latching current	$t_p = 10 \mu s$	$T_{VJ} = 25^{\circ}C$		90	mA
		$I_G = 0.2 A; di_G/dt = 0.2 A/\mu s$				
$I_H$	holding current	$V_D = 6 V \quad R_{GK} = \infty$	$T_{VJ} = 25^{\circ}C$		60	mA
$t_{gd}$	gate controlled delay time	$V_D = \frac{1}{2} V_{DRM}$	$T_{VJ} = 25^{\circ}C$		2	$\mu s$
		$I_G = 0.5 A; di_G/dt = 0.5 A/\mu s$				
$t_q$	turn-off time	$V_R = 100 V; I_T = 20 A; V = \frac{2}{3} V_{DRM}$ $di/dt = 10 A/\mu s \quad dv/dt = 20 V/\mu s \quad t_p = 200 \mu s$	$T_{VJ} = 125^{\circ}C$		150	$\mu s$



Package TO-263 (D2Pak-HV)			Ratings			
Symbol	Definition	Conditions	min.	typ.	max.	Unit
$I_{RMS}$	RMS current	per terminal			35	A
$T_{VJ}$	virtual junction temperature		-40		150	°C
$T_{op}$	operation temperature		-40		125	°C
$T_{stg}$	storage temperature		-40		150	°C
<b>Weight</b>				1.5		g
$F_C$	mounting force with clip		20		60	N
$d_{Spp/App}$	creepage distance on surface / striking distance through air	terminal to terminal	4.2			mm
$d_{Spb/Apb}$		terminal to backside	4.7			mm

**Product Marking**



**Part description**

- C = Thyristor (SCR)
- M = Thyristor
- A = (up to 1800V)
- 20 = Current Rating [A]
- E = Single Thyristor
- 1600 = Reverse Voltage [V]
- PZ = TO-263AB (D2Pak) (2HV)

Ordering	Ordering Number	Marking on Product	Delivery Mode	Quantity	Code No.
Standard	CMA20E1600PZ-TRL	CMA20E1600PZ	Tape & Reel	800	515174
Alternative	CMA20E1600PZ-TUB	CMA20E1600PZ	Tube	50	523814

Similar Part	Package	Voltage class
CMA20E1600PB	TO-220AB (3)	1600

**Equivalent Circuits for Simulation**

\* on die level

$T_{VJ} = 150\text{ °C}$



**Thyristor**

$V_{0\ max}$	threshold voltage	0.92	V
$R_{0\ max}$	slope resistance *	25	mΩ



**Outlines TO-263 (D2Pak-HV)**

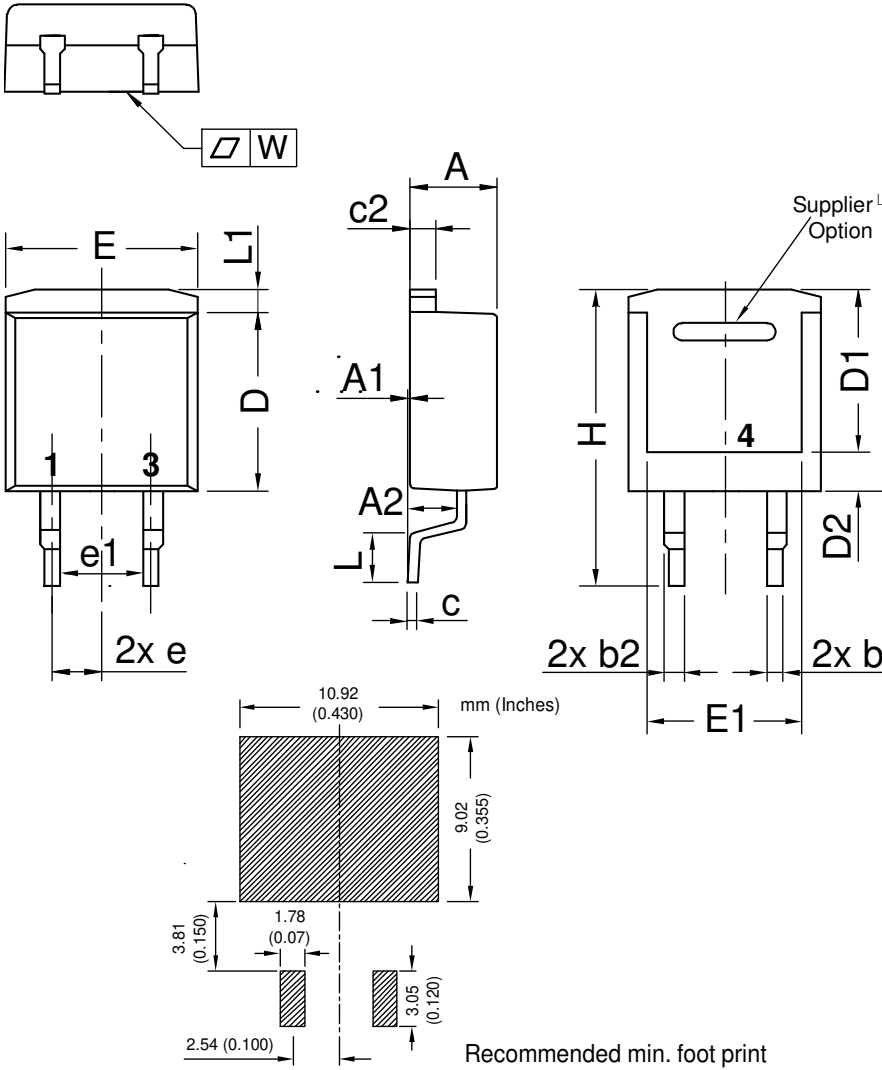

Dim.	Millimeter		Inches	
	min	max	min	max
A	4.06	4.83	0.160	0.190
A1	typ. 0.10		typ. 0.004	
A2	2.41		0.095	
b	0.51	0.99	0.020	0.039
b2	1.14	1.40	0.045	0.055
c	0.40	0.74	0.016	0.029
c2	1.14	1.40	0.045	0.055
D	8.38	9.40	0.330	0.370
D1	8.00	8.89	0.315	0.350
D2	2.3		0.091	
E	9.65	10.41	0.380	0.410
E1	6.22	8.50	0.245	0.335
e	2,54 BSC		0,100 BSC	
e1	4.28		0.169	
H	14.61	15.88	0.575	0.625
L	1.78	2.79	0.070	0.110
L1	1.02	1.68	0.040	0.066
W	typ. 0.02	0.040	typ. 0.0008	0.002

*All dimensions conform with and/or within JEDEC standard.*

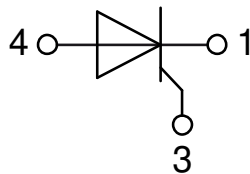

**Thyristor**

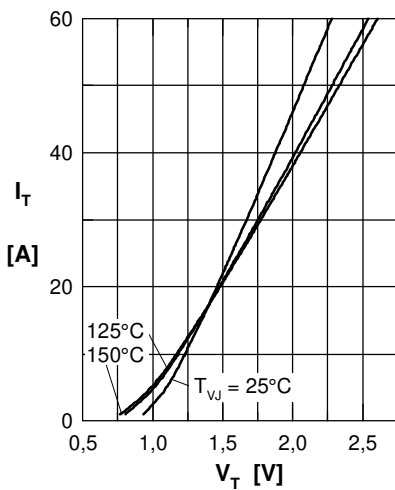

Fig. 1 Forward characteristics

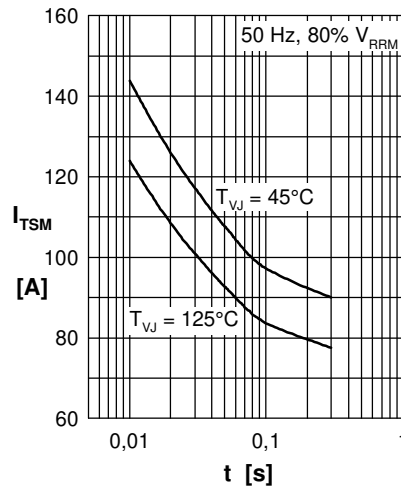

Fig. 2 Surge overload current

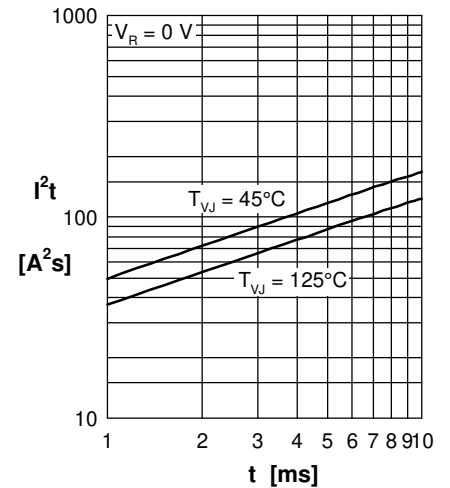

Fig. 3  $I^2t$  versus time (1-10 ms)

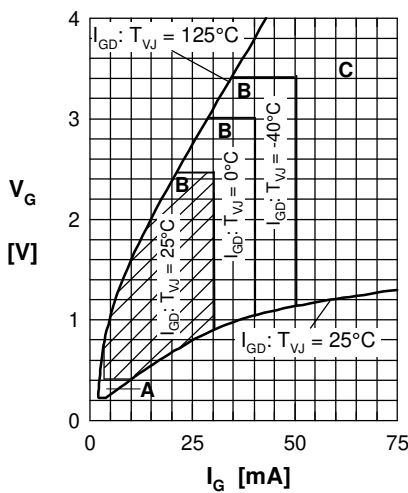

Fig. 4 Gate trigger characteristics

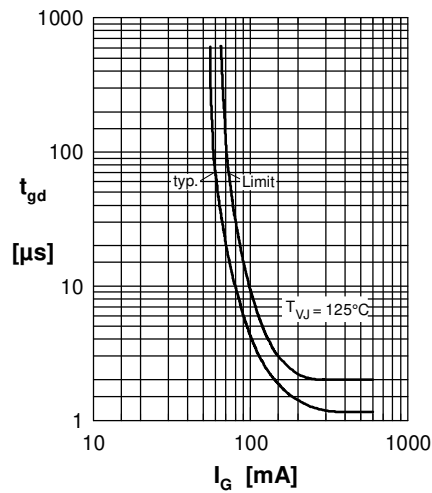

Fig. 5 Gate controlled delay time

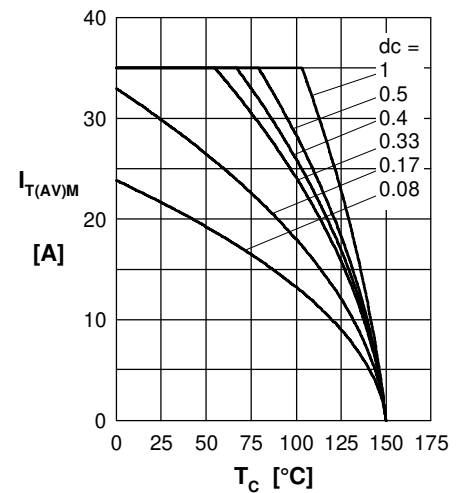

Fig. 6 Max. forward current at case temperature

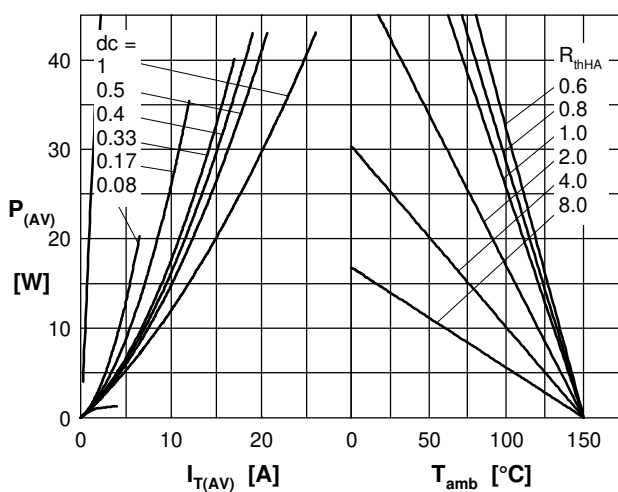

Fig. 7a Power dissipation versus direct output current  
Fig. 7b and ambient temperature

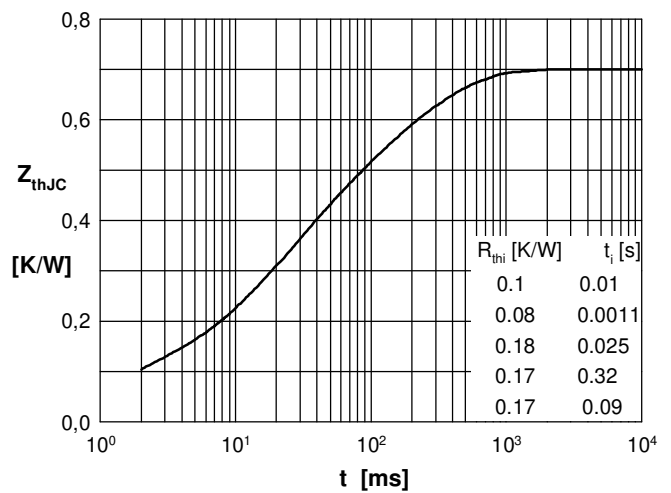

Fig. 8 Transient thermal impedance