



# Thyristor

$$V_{RRM} = 800 \text{ V}$$

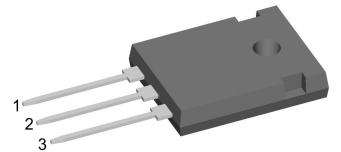
$$I_{TAV} = 45 \text{ A}$$

$$V_T = 1.37 \text{ V}$$

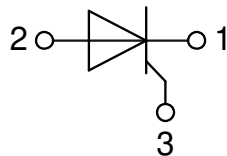
## Single Thyristor

Part number

**CS45-08io1**



Backside: anode



### Features / Advantages:

- Thyristor for line frequency
- Planar passivated chip
- Long-term stability

### Applications:

- Line rectifying 50/60 Hz
- Softstart AC motor control
- DC Motor control
- Power converter
- AC power control
- Lighting and temperature control

### Package: TO-247

- Industry standard outline
- RoHS compliant
- Epoxy meets UL 94V-0

### Disclaimer Notice

Information furnished is believed to be accurate and reliable. However, users should independently evaluate the suitability of and test each product selected for their own applications. Littelfuse products are not designed for, and may not be used in, all applications. Read complete Disclaimer Notice at [www.littelfuse.com/disclaimer-electronics](http://www.littelfuse.com/disclaimer-electronics).

| Thyristor      |  |   |                           | Ratings |      |                   |  |
|----------------|--|---|---------------------------|---------|------|-------------------|--|
| Symbol         | Definition   | Conditions  | min.                      | typ.    | max. | Unit              |  |
| $V_{RSM/DSM}$  | max. non-repetitive reverse/forward blocking voltage | $T_{VJ} = 25^{\circ}C$  |                           |         | 900  | V                 |  |
| $V_{RRM/DRM}$  | max. repetitive reverse/forward blocking voltage     | $T_{VJ} = 25^{\circ}C$  |                           |         | 800  | V                 |  |
| $I_{RD}$       | reverse current, drain current                       | $V_{R/D} = 800 V$   | $T_{VJ} = 25^{\circ}C$    |         | 50   | $\mu A$           |  |
|                |  | $V_{R/D} = 800 V$   | $T_{VJ} = 125^{\circ}C$   |         | 3    | mA                |  |
| $V_T$          | forward voltage drop                                 | $I_T = 45 A$  | $T_{VJ} = 25^{\circ}C$    |         | 1.36 | V                 |  |
|                |  | $I_T = 90 A$  |                           |         | 1.73 | V                 |  |
|                |  | $I_T = 45 A$  | $T_{VJ} = 125^{\circ}C$   |         | 1.37 | V                 |  |
|                |  | $I_T = 90 A$  |                           |         | 1.85 | V                 |  |
| $I_{TAV}$      | average forward current                              | $T_C = 110^{\circ}C$  | $T_{VJ} = 150^{\circ}C$   |         | 45   | A                 |  |
| $I_{T(RMS)}$   | RMS forward current                                  | 180° sine   |                           |         | 71   | A                 |  |
| $V_{T0}$       | threshold voltage                                    | } for power loss calculation only   | $T_{VJ} = 150^{\circ}C$   |         | 0.88 | V                 |  |
| $r_T$          | slope resistance                                     |   |                           |         | 11   | m $\Omega$        |  |
| $R_{thJC}$     | thermal resistance junction to case                  |   |                           |         | 0.4  | K/W               |  |
| $R_{thCH}$     | thermal resistance case to heatsink                  |   |                           | 0.3     |      | K/W               |  |
| $P_{tot}$      | total power dissipation                              |   | $T_C = 25^{\circ}C$       |         | 310  | W                 |  |
| $I_{TSM}$      | max. forward surge current                           | $t = 10 \text{ ms}; (50 \text{ Hz}), \text{ sine}$  | $T_{VJ} = 45^{\circ}C$    |         | 520  | A                 |  |
|                |  | $t = 8,3 \text{ ms}; (60 \text{ Hz}), \text{ sine}$   | $V_R = 0 V$               |         | 560  | A                 |  |
|                |  | $t = 10 \text{ ms}; (50 \text{ Hz}), \text{ sine}$  | $T_{VJ} = 150^{\circ}C$   |         | 440  | A                 |  |
|                |  | $t = 8,3 \text{ ms}; (60 \text{ Hz}), \text{ sine}$   | $V_R = 0 V$               |         | 475  | A                 |  |
| $I^2t$         | value for fusing                                     | $t = 10 \text{ ms}; (50 \text{ Hz}), \text{ sine}$  | $T_{VJ} = 45^{\circ}C$    |         | 1.35 | kA <sup>2</sup> s |  |
|                |  | $t = 8,3 \text{ ms}; (60 \text{ Hz}), \text{ sine}$   | $V_R = 0 V$               |         | 1.31 | kA <sup>2</sup> s |  |
|                |  | $t = 10 \text{ ms}; (50 \text{ Hz}), \text{ sine}$  | $T_{VJ} = 150^{\circ}C$   |         | 970  | A <sup>2</sup> s  |  |
|                |  | $t = 8,3 \text{ ms}; (60 \text{ Hz}), \text{ sine}$   | $V_R = 0 V$               |         | 940  | A <sup>2</sup> s  |  |
| $C_J$          | junction capacitance                                 | $V_R = 230 V \quad f = 1 \text{ MHz}$   | $T_{VJ} = 25^{\circ}C$    |         | 29   | pF                |  |
| $P_{GM}$       | max. gate power dissipation                          | $t_p = 30 \mu s$  | $T_C = 150^{\circ}C$      |         | 10   | W                 |  |
|                |  | $t_p = 300 \mu s$   |                           |         | 5    | W                 |  |
| $P_{GAV}$      | average gate power dissipation                       |   |                           |         | 0.5  | W                 |  |
| $(di/dt)_{cr}$ | critical rate of rise of current                     | $T_{VJ} = 125^{\circ}C; f = 50 \text{ Hz}$  | repetitive, $I_T = 135 A$ |         | 150  | A/ $\mu s$        |  |
|                |  | $t_p = 200 \mu s; di_G/dt = 0.3 A/\mu s;$<br>$I_G = 0.3 A; V = \frac{2}{3} V_{DRM}$                                       | non-repet., $I_T = 45 A$  |         | 500  | A/ $\mu s$        |  |
| $(dv/dt)_{cr}$ | critical rate of rise of voltage                     | $V = \frac{2}{3} V_{DRM}$<br>$R_{GK} = \infty; \text{ method 1 (linear voltage rise)}$                                    | $T_{VJ} = 125^{\circ}C$   |         | 1000 | V/ $\mu s$        |  |
| $V_{GT}$       | gate trigger voltage                                 | $V_D = 6 V$   | $T_{VJ} = 25^{\circ}C$    |         | 1.5  | V                 |  |
|                |  |   | $T_{VJ} = -40^{\circ}C$   |         | 1.6  | V                 |  |
| $I_{GT}$       | gate trigger current                                 | $V_D = 6 V$   | $T_{VJ} = 25^{\circ}C$    |         | 80   | mA                |  |
|                |  |   | $T_{VJ} = -40^{\circ}C$   |         | 200  | mA                |  |
| $V_{GD}$       | gate non-trigger voltage                             | $V_D = \frac{2}{3} V_{DRM}$   | $T_{VJ} = 125^{\circ}C$   |         | 0.2  | V                 |  |
| $I_{GD}$       | gate non-trigger current                             |   |                           |         | 10   | mA                |  |
| $I_L$          | latching current                                     | $t_p = 10 \mu s$  | $T_{VJ} = 25^{\circ}C$    |         | 150  | mA                |  |
|                |  | $I_G = 0.3 A; di_G/dt = 0.3 A/\mu s$  |                           |         |      |                   |  |
| $I_H$          | holding current                                      | $V_D = 6 V \quad R_{GK} = \infty$   | $T_{VJ} = 25^{\circ}C$    |         | 100  | mA                |  |
| $t_{gd}$       | gate controlled delay time                           | $V_D = \frac{1}{2} V_{DRM}$   | $T_{VJ} = 25^{\circ}C$    |         | 2    | $\mu s$           |  |
|                |  | $I_G = 0.3 A; di_G/dt = 0.3 A/\mu s$  |                           |         |      |                   |  |
| $t_q$          | turn-off time  | $V_R = 100 V; I_T = 45 A; V = \frac{2}{3} V_{DRM}$<br>$di/dt = 15 A/\mu s \quad dv/dt = 20 V/\mu s \quad t_p = 200 \mu s$ | $T_{VJ} = 125^{\circ}C$   |         | 150  | $\mu s$           |  |



| Package TO-247 |                              |              | Ratings |      |      |      |
|----------------|------------------------------|--------------|---------|------|------|------|
| Symbol         | Definition                   | Conditions   | min.    | typ. | max. | Unit |
| $I_{RMS}$      | RMS current                  | per terminal |         |      | 70   | A    |
| $T_{VJ}$       | virtual junction temperature |              | -40     |      | 150  | °C   |
| $T_{op}$       | operation temperature        |              | -40     |      | 125  | °C   |
| $T_{stg}$      | storage temperature          |              | -40     |      | 150  | °C   |
| <b>Weight</b>  |                              |              |         | 6    |      | g    |
| $M_D$          | mounting torque              |              | 0.8     |      | 1.2  | Nm   |
| $F_C$          | mounting force with clip     |              | 20      |      | 120  | N    |

**Product Marking**



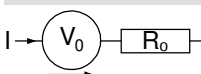
| Ordering | Ordering Number | Marking on Product | Delivery Mode | Quantity | Code No. |
|----------|-----------------|--------------------|---------------|----------|----------|
| Standard | CS45-08io1      | CS45-08io1         | Tube          | 30       | 467677   |

| Similar Part | Package        | Voltage class |
|--------------|----------------|---------------|
| CS45-12io1   | TO-247AD (3)   | 1200          |
| CS45-16io1   | TO-247AD (3)   | 1600          |
| CS45-16io1R  | ISOPLUS247 (3) | 1600          |
| CLA50E1200HB | TO-247AD (3)   | 1200          |

**Equivalent Circuits for Simulation**

\* on die level

$T_{VJ} = 150^{\circ}C$

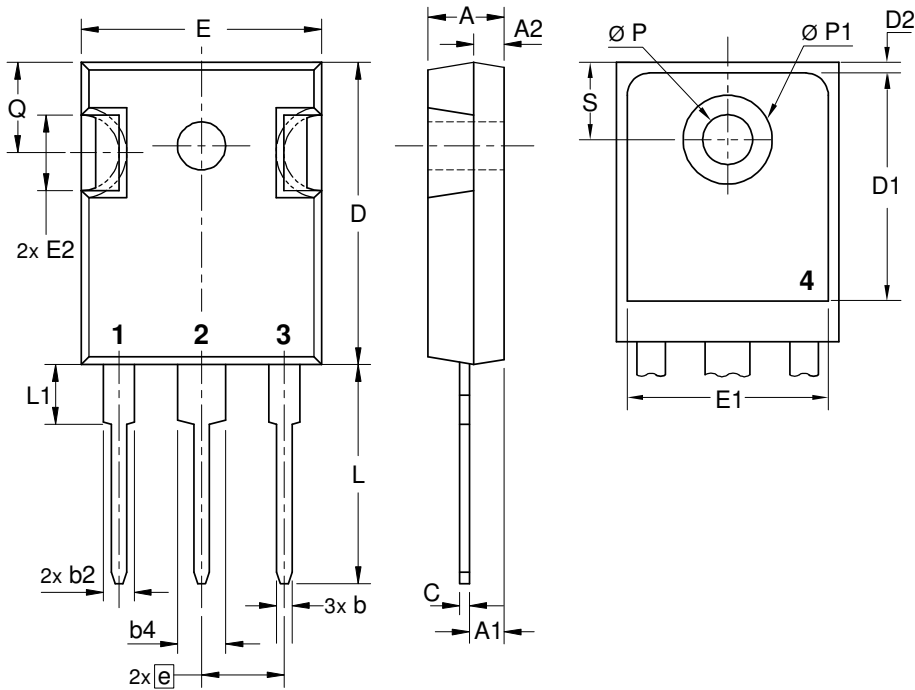


**Thyristor**

|              |                    |      |    |
|--------------|--------------------|------|----|
| $V_{0\ max}$ | threshold voltage  | 0.88 | V  |
| $R_{0\ max}$ | slope resistance * | 8.5  | mΩ |



**Outlines TO-247**



| Sym. | Inches    |       | Millimeter |       |
|------|-----------|-------|------------|-------|
|      | min.      | max.  | min.       | max.  |
| A    | 0.185     | 0.209 | 4.70       | 5.30  |
| A1   | 0.087     | 0.102 | 2.21       | 2.59  |
| A2   | 0.059     | 0.098 | 1.50       | 2.49  |
| D    | 0.819     | 0.845 | 20.79      | 21.45 |
| E    | 0.610     | 0.640 | 15.48      | 16.24 |
| E2   | 0.170     | 0.216 | 4.31       | 5.48  |
| e    | 0.215 BSC |       | 5.46 BSC   |       |
| L    | 0.780     | 0.800 | 19.80      | 20.30 |
| L1   | -         | 0.177 | -          | 4.49  |
| Ø P  | 0.140     | 0.144 | 3.55       | 3.65  |
| Q    | 0.212     |       | 5.38       |       |
| S    | 0.242 BSC |       | 6.14 BSC   |       |
| b    | 0.039     | 0.055 | 0.99       | 1.40  |
| b2   | 0.065     | 0.094 | 1.65       | 2.39  |
| b4   | 0.102     | 0.135 | 2.59       | 3.43  |
| c    | 0.015     | 0.035 | 0.38       | 0.89  |
| D1   | 0.515     | -     | 13.07      | -     |
| D2   | 0.020     | 0.053 | 0.51       | 1.35  |
| E1   | 0.530     | -     | 13.45      | -     |
| Ø P1 | -         | 0.29  | -          | 7.39  |



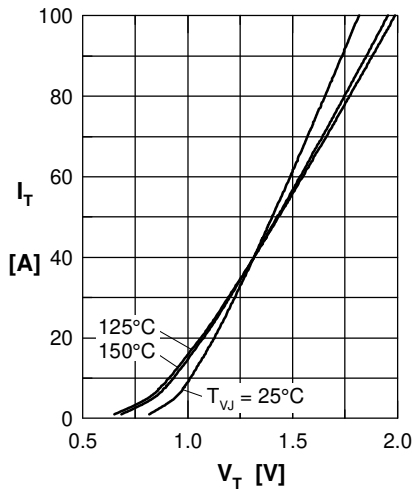
**Thyristor**


Fig. 1 Forward characteristics

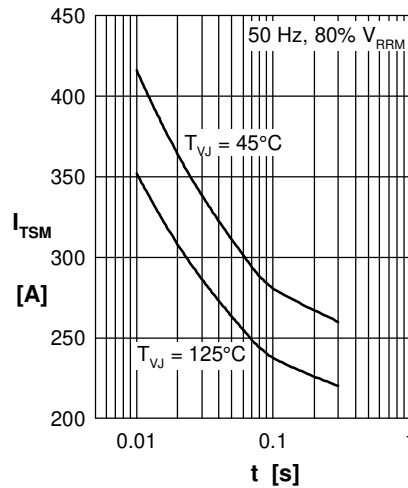


Fig. 2 Surge overload current

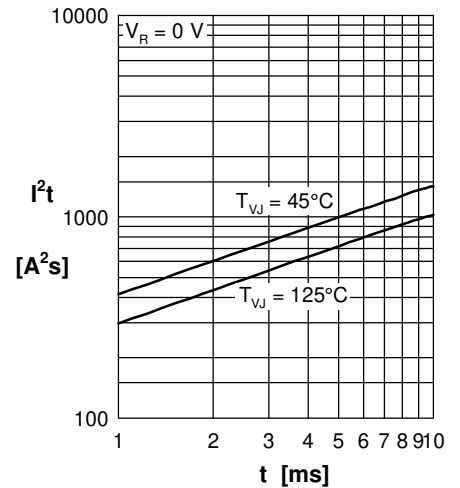
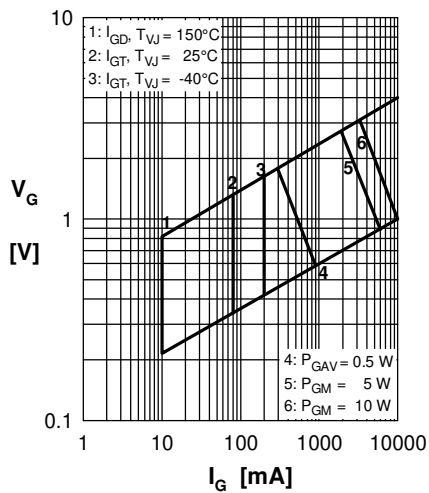

 Fig. 3  $I^2t$  versus time (1-10 ms)


Fig. 4 Gate trigger characteristics

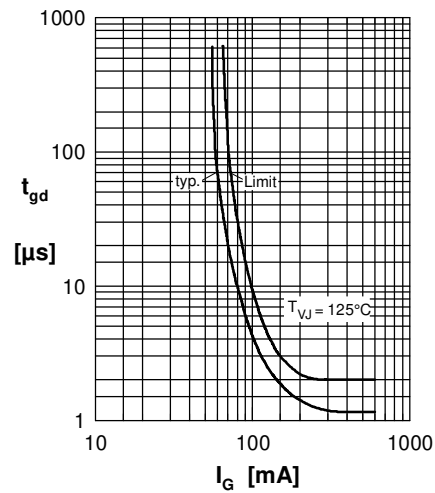


Fig. 5 Gate controlled delay time

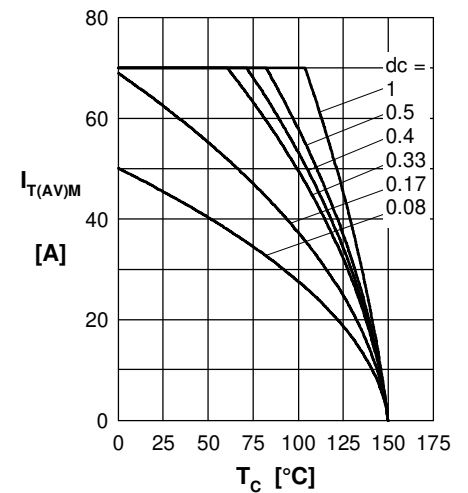


Fig. 6 Max. forward current at case temperature

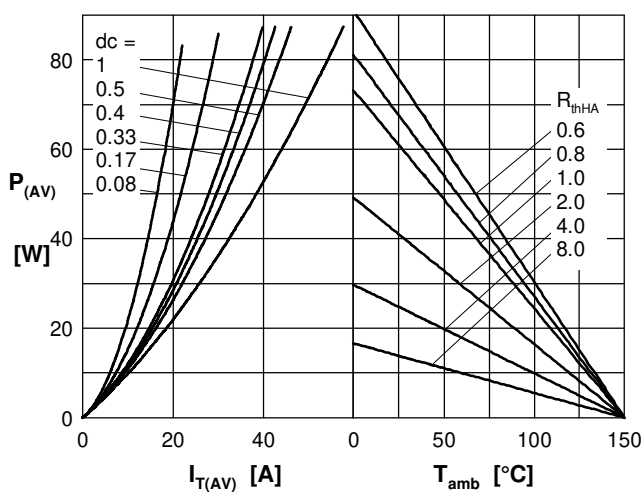
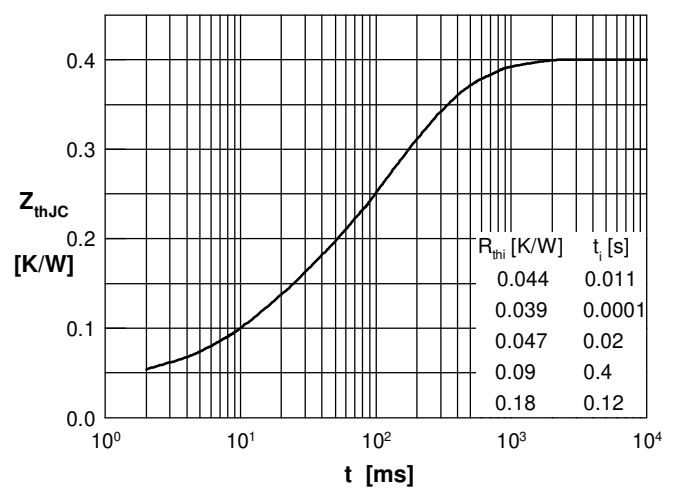

 Fig. 7a Power dissipation versus direct output current  
 Fig. 7b and ambient temperature


Fig. 8 Transient thermal impedance junction to case