

SiC Schottky Diode

$$V_{RRM} = 2 \times 1200 \text{ V}$$

$$I_{FAV} = 18.5 \text{ A}$$

Ultra fast switching
 Zero reverse recovery
 Phase leg

Part number
DCG17P1200HR

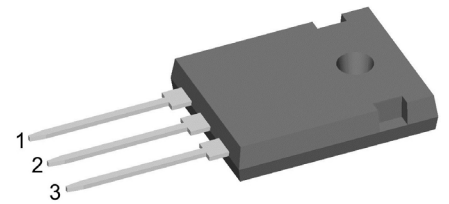

Backside: isolated

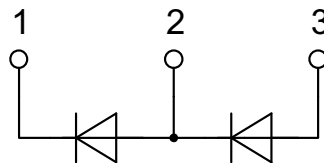
Features / Advantages:

- Ultra fast switching
- Zero reverse recovery
- Zero forward recovery
- Temperature independent switching behavior
- Positive temperature coefficient of forward voltage
- $T_{VJM} = 175^{\circ}\text{C}$

Applications:

- Solar inverter
- Uninterruptible power supply (UPS)
- Welding equipment
- Switched-mode power supplies
- Medical equipment
- High speed rectifier

Package: ISO247

- Isolation Voltage: 3000 V~
- Industry standard outline
- RoHS compliant
- Epoxy meets UL 94V-0
- Soldering pins for PCB mounting
- Backside: DCB ceramic
- Reduced weight
- Advanced power cycling

Disclaimer Notice

Information furnished is believed to be accurate and reliable. However, users should independently evaluate the suitability of and test each product selected for their own applications. Littelfuse products are not designed for, and may not be used in, all applications. Read complete Disclaimer Notice at www.littelfuse.com/disclaimer-electronics.

SiC Diode (per diode)				Ratings			
Symbol	Definitions	Conditions	min.	typ.	max.		
V_{RSM}	max. non-repetitive reverse blocking voltage				1200	V	
V_{RRM}	max. repetitive reverse blocking voltage				1200	V	
I_R	reverse current	$V_R = V_{RRM}$	$T_{VJ} = 25^\circ\text{C}$		35	200	μA
			$T_{VJ} = 175^\circ\text{C}$		65	400	μA
V_F	forward voltage	$I_F = 20\text{ A}$ $I_F = 40\text{ A}$	$T_{VJ} = 25^\circ\text{C}$		1.5	1.8	V
							V
		$I_F = 20\text{ A}$ $I_F = 40\text{ A}$	$T_{VJ} = 175^\circ\text{C}$		2.2	3.0	V
							V
I_{FAV}	average forward current	$T_C = 80^\circ\text{C}$ $T_C = 100^\circ\text{C}$	rectangular, d = 0.5 $T_{VJ} = 175^\circ\text{C}$		18.5	A	
					17.0	A	
I_{F25}	forward current	based on typ. V_{F0} and r_F	$T_C = 25^\circ\text{C}$		34	A	
I_{F80}			$T_C = 80^\circ\text{C}$		26.5	A	
I_{F100}			$T_C = 100^\circ\text{C}$		23	A	
I_{FSM}	max forward surge current	t = 10 ms, half sine (50 Hz) $t_p = 10\ \mu\text{s}$, pulse	$T_{VJ} = 25^\circ\text{C}$ $V_R = 0\text{V}$		1000	A	
V_{F0}	threshold voltage	} for power loss calculation	$T_{VJ} = 125^\circ\text{C}$ 175°C $T_{VJ} = 125^\circ\text{C}$ 175°C		0.78	V	
r_F	slope resistance				0.73	V	
					57.0	$\text{m}\Omega$	
					70.5	$\text{m}\Omega$	
Q_C	total capacitive charge	$V_R = 800\text{ V}$, $I_F = 20\text{ A}$ $di/dt = 200\text{ A}/\mu\text{s}$	$T_{VJ} = 25^\circ\text{C}$		99	nC	
C	total capacitance	$V_R = 0\text{ V}$ $V_R = 400\text{ V}$ $V_R = 800\text{ V}$	$T_{VJ} = 25^\circ\text{C}$, f = 1 MHz		1500	pF	
					93	pF	
					67	pF	
R_{thJC}	thermal resistance junction to case	with heatsink compound; IXYS test setup			1.4	K/W	
R_{thJH}	thermal resistance junction to heatsink			1.6	K/W		

Package ISO247			Ratings			
Symbol	Definitions	Conditions	min.	typ.	max.	
I_{RMS}	RMS current	per terminal			70	A
T_{stg}	storage temperature		-40		150	°C
T_{op}	operation temperature		-40		150	°C
T_{VJ}	virtual junction temperature		-40		175	°C
Weight				6		g
M_D	mounting torque		0.8		1.2	Nm
F_C	mounting force with clip		40		120	N
$d_{Spp/App}$	creepage distance on surface /	terminal to terminal	2.7			mm
$d_{Spb/Appb}$	striking distance through air	terminal to backside	4.1			mm
V_{ISOL}	isolation voltage	$t = 1$ second $t = 1$ minute		3600 3000		V V
		50/60 Hz; RMS; $I_{ISOL} < 1$ mA				

Product Marking

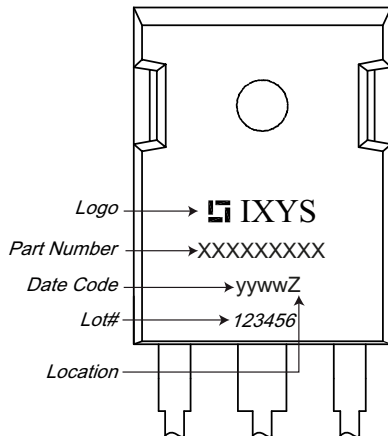

Part description

D = Diode
 C = SiC
 G = Extreme fast
 17 = Current Rating [A]
 P = Phase leg
 1200 = Reverse Voltage [V]
 HR = ISO247 (3)

Ordering	Part Name	Marking on Product	Delivering Mode	Base Qty	Ordering Code
Standard	DCG17P1200HR	DCG17P1200HR	Tube	30	DCG17P1200HR

Equivalent Circuits for Simulation *on die level, typical

		$T_{VJ} = 125^\circ\text{C}$	$T_{VJ} = 175^\circ\text{C}$	
V_0	threshold voltage	0.78	0.73	V
R_0	slope resistance *	57.0	70.5	mΩ

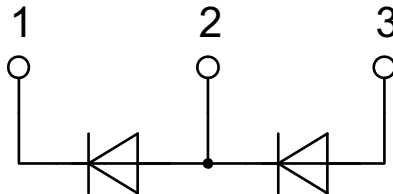
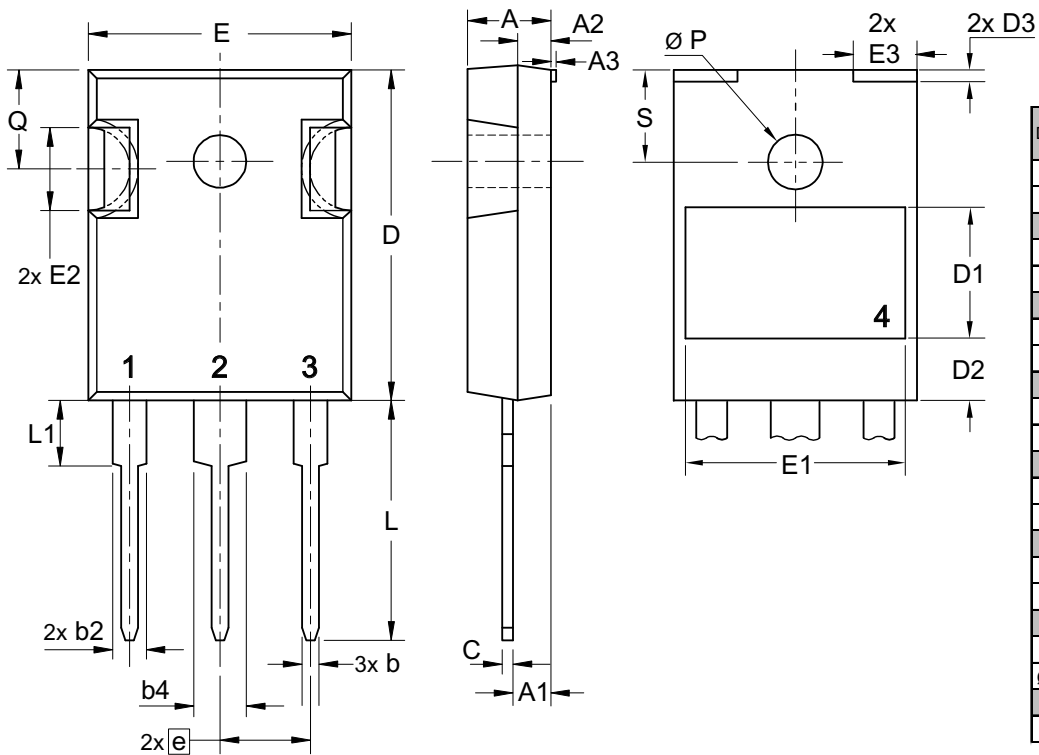
Outlines ISO247

SiC Diode (per diode)

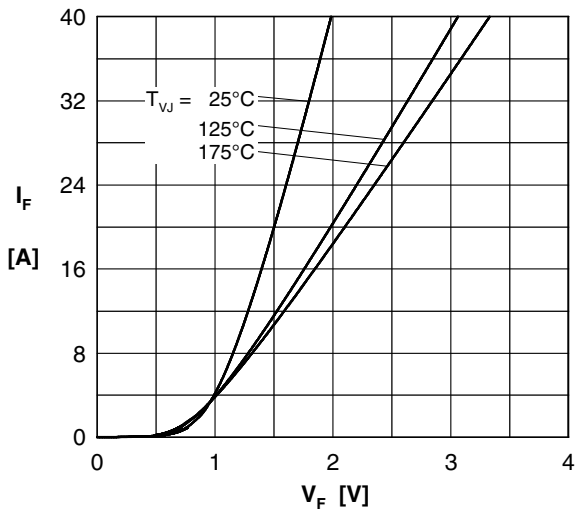

Fig. 1 Typ. forward characteristics.

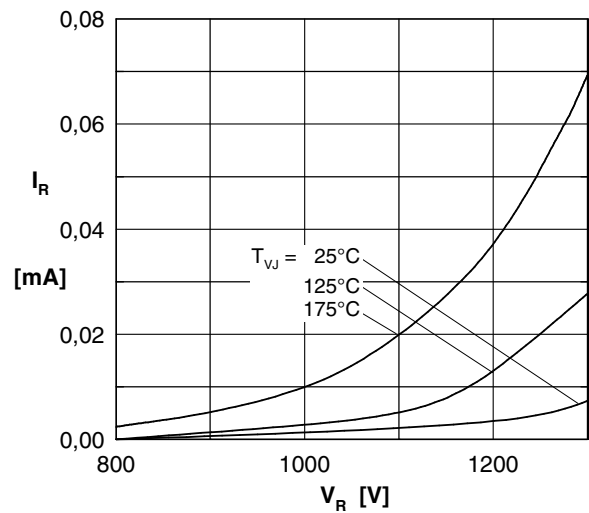

Fig. 2 Typ. reverse characteristics

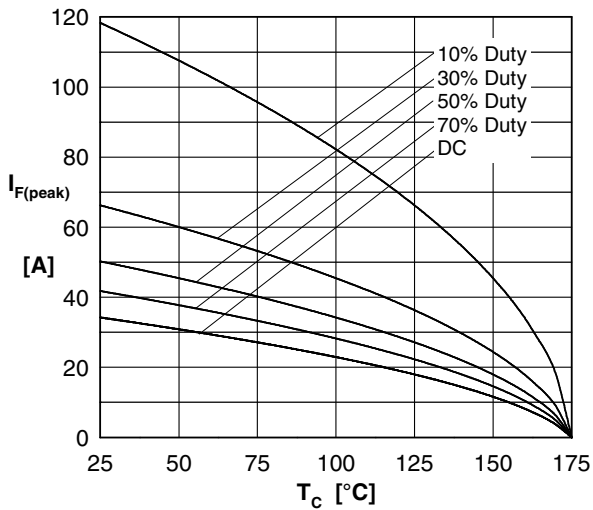

Fig. 3 Typ. current derating

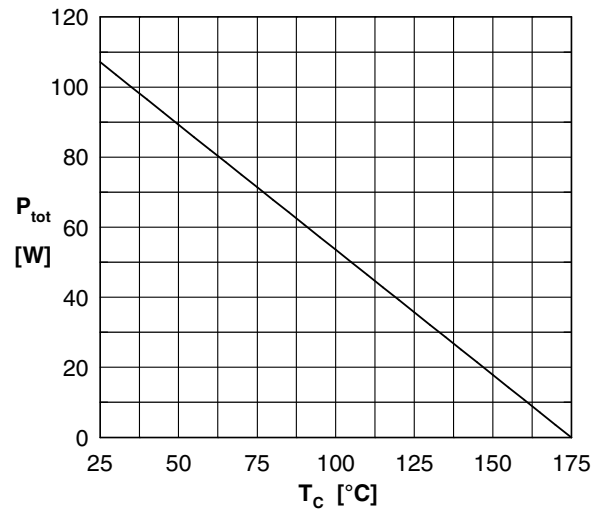

Fig. 4 Power derating

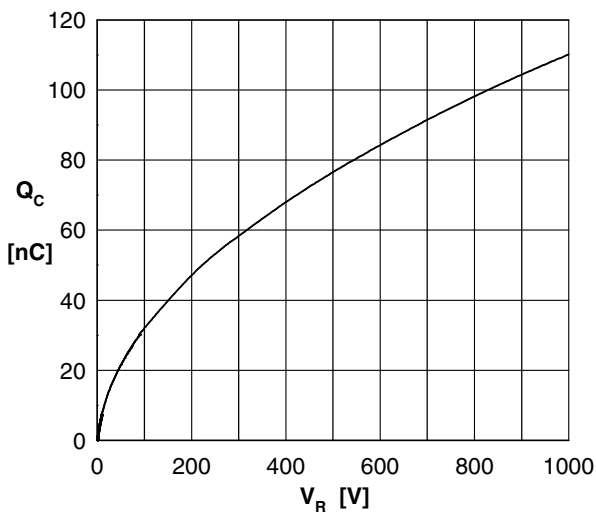

Fig. 5 Typ. recovery charge vs. reverse voltage

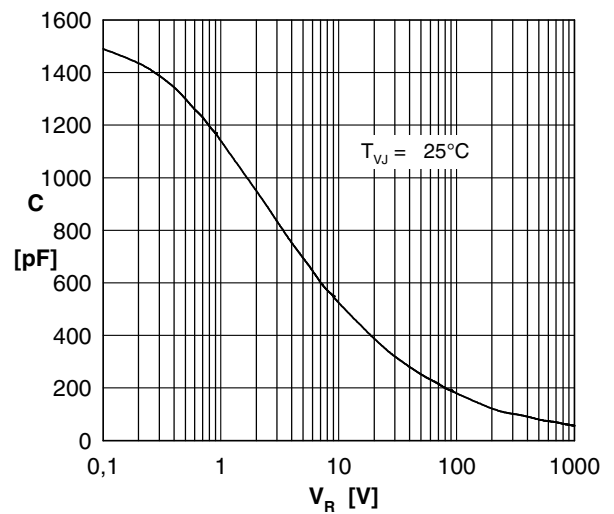

Fig. 6 Typ. junction capacitance vs. reverse Voltage

SiC Diode (per diode)

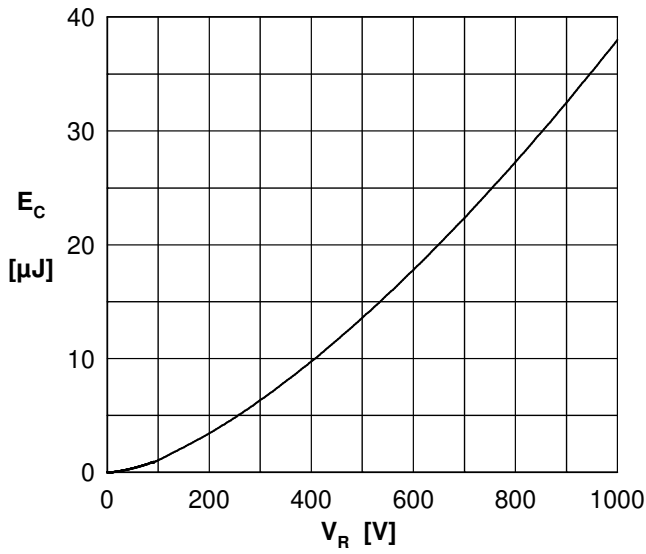

Fig. 7 Typical capacitance stored energy

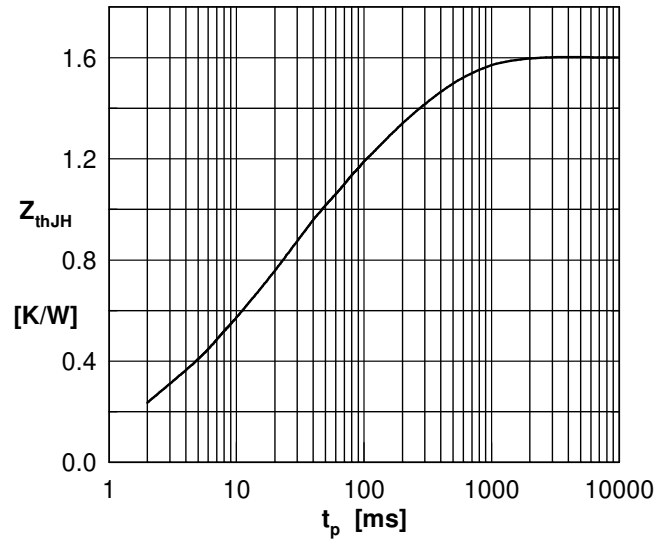

Fig. 8 Typ. transient thermal impedance junction to heatsink