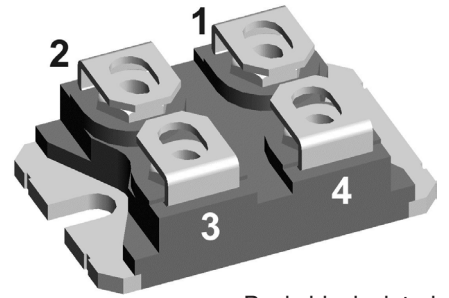


SiC Schottky Diode


 $V_{RRM} = 1200\text{ V}$
 $I_{FAV} = 2 \times 41\text{ A}$

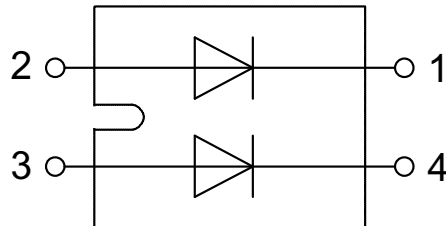
Ultra fast switching
 Zero reverse recovery

Part number
DCG85X1200NA



Backside: isolated

 E72873



Features / Advantages:

- Ultra fast switching
- Zero reverse recovery
- Zero forward recovery
- Temperature independent switching behavior
- Positive temperature coefficient of forward voltage
- $T_{VJM} = 175^{\circ}\text{C}$

Applications:

- Solar inverter
- Uninterruptible power supply (UPS)
- Welding equipment
- Switched-mode power supplies
- Medical equipment
- High speed rectifier

Package: SOT-227B (minibloc)

- Isolation Voltage: 2500 V~
- Industry standard outline
- RoHS compliant
- Epoxy meets UL 94V-0
- Base plate with Aluminium nitride isolation for low thermal resistance
- Advanced power cycling

Disclaimer Notice

Information furnished is believed to be accurate and reliable. However, users should independently evaluate the suitability of and test each product selected for their own applications. Littelfuse products are not designed for, and may not be used in, all applications. Read complete Disclaimer Notice at www.littelfuse.com/disclaimer-electronics.

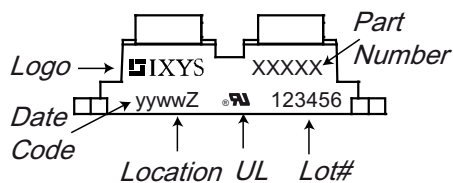
SiC Diode (per leg)				Ratings			
Symbol	Definitions	Conditions	min.	typ.	max.		
V_{RSM}	max. non-repetitive reverse blocking voltage	$T_{VJ} = 25^{\circ}\text{C}$			1200	V	
V_{RRM}	max. repetitive reverse blocking voltage	$T_{VJ} = 25^{\circ}\text{C}$			1200	V	
I_R	reverse current	$V_R = V_{RRM}$ $T_{VJ} = 25^{\circ}\text{C}$ $T_{VJ} = 175^{\circ}\text{C}$		70 130	400 800	μA μA	
V_F	forward voltage	$I_F = 20\text{ A}$ $I_F = 40\text{ A}$	$T_{VJ} = 25^{\circ}\text{C}$	1.2		V	
				1.5	1.8	V	
		$I_F = 20\text{ A}$ $I_F = 40\text{ A}$	$T_{VJ} = 175^{\circ}\text{C}$	1.3		V	
				2.20	3.0	V	
I_{FAV}	average forward current	$T_C = 80^{\circ}\text{C}$ $T_C = 100^{\circ}\text{C}$	rectangular, $d = 0.5$ $T_{VJ} = 175^{\circ}\text{C}$		41	A	
					36	A	
I_{F25}	forward current	based on typ. V_{F0} and r_F $T_C = 25^{\circ}\text{C}$			73	A	
I_{F80}		$T_C = 80^{\circ}\text{C}$			56	A	
I_{F100}		$T_C = 100^{\circ}\text{C}$			49	A	
I_{FSM}	max forward surge current	$t = 10\text{ ms}$, half sine (50 Hz) $t_p = 10\text{ }\mu\text{s}$, pulse; $V_R = 0\text{ V}$	$T_{VJ} = 25^{\circ}\text{C}$		1150	A A	
V_{F0}	threshold voltage	} for power loss calculation	$T_{VJ} = 125^{\circ}\text{C}$	0.80		V	
r_F	slope resistance		$T_{VJ} = 175^{\circ}\text{C}$	0.73		V	
			$T_{VJ} = 125^{\circ}\text{C}$	28.4		$\text{m}\Omega$	
			$T_{VJ} = 175^{\circ}\text{C}$	35.2		$\text{m}\Omega$	
Q_C	total capacitive charge	$V_R = 800\text{ V}$, $I_F = 40\text{ A}$ $di/dt = 400\text{ A}/\mu\text{s}$	$T_{VJ} = 25^{\circ}\text{C}$	200		nC	
C	total capacitance	$V_R = 0\text{ V}$ $V_R = 400\text{ V}$ $V_R = 800\text{ V}$	} $f = 1\text{ MHz}$; $T_{VJ} = 25^{\circ}\text{C}$	3000		pF	
				185		pF	
				135		pF	
R_{thJC}	thermal resistance junction to case	with heatsink compound; IXYS test setup			0.60	K/W	
R_{thJH}	thermal resistance junction to heatsink			0.72		K/W	



Package Outlines SOT-227B (minibloc)			Ratings			
Symbol	Definitions	Conditions	min.	typ.	max.	Unit
I_{RMS}	RMS current	per terminal			100	A
T_{stg}	storage temperature		-40		150	°C
T_{op}	operation temperature		-40		150	°C
T_{VJ}	virtual junction temperature		-40		175	°C
Weight				30		g
M_D	mounting torque ¹⁾	screws to heatsink terminal connection screws			1.5 1.3	Nm Nm
d_{Spp}	creepage distance on surface	terminal to terminal	10.5			mm
d_{Spb}		terminal to backside	8.5			mm
d_{App}	striking distance through air	terminal to terminal	3.2			mm
d_{Apb}		terminal to backside	6.8			mm
V_{ISOL}	isolation voltage	$I_{ISOL} \leq 1 \text{ mA}; 50/60 \text{ Hz}$	$t = 1 \text{ sec.}$ $t = 1 \text{ minute}$		3000 2500	V V
C_p	coupling capacity per switch	between shorted terminals of one diode and back side metallization		20		pF

¹⁾ further information see application note IXAN0073 on www.ixys.com/TechnicalSupport/appnotes.aspx (General / Isolation, Mounting, Soldering, Cooling)

Product Marking



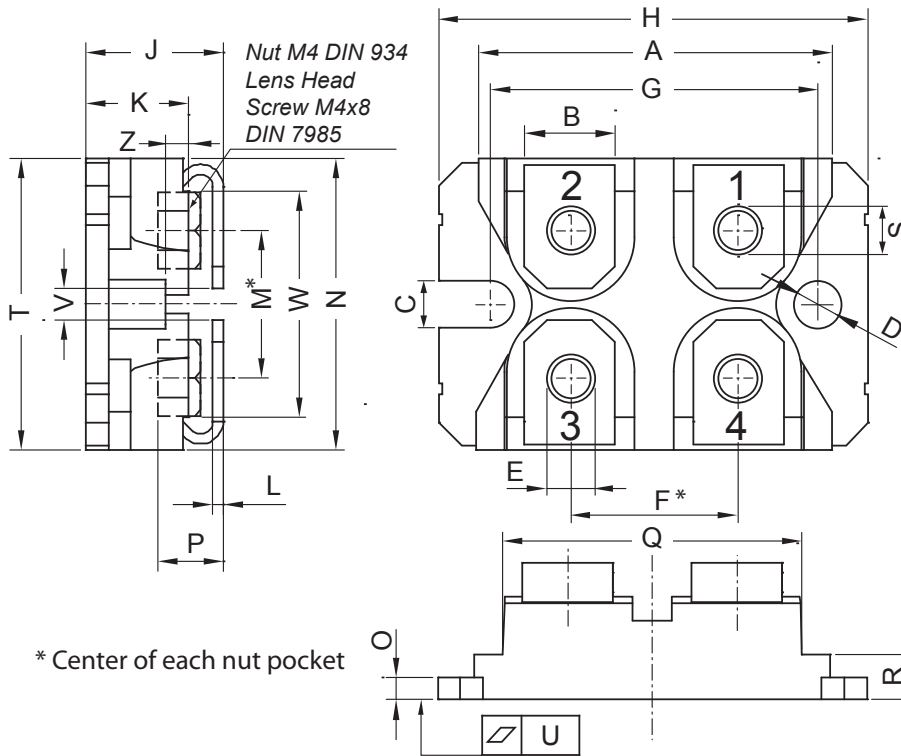
Part description

- D = Diode
- C = SiC
- G = extreme fast
- 85 = Current Rating [A]
- X = Parallel legs
- 1200 = Reverse Voltage [V]
- NA = SOT-227 (minibloc)

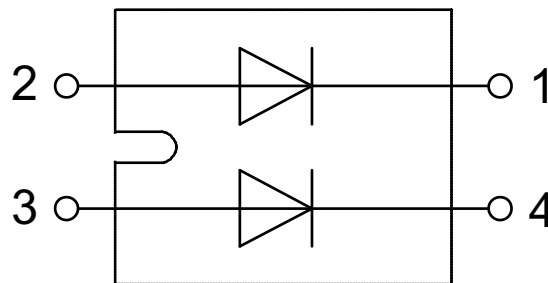
Ordering	Part Name	Marking on Product	Delivering Mode	Base Qty	Ordering Code
Standard	DCG85X1200NA	DCG85X1200NA	Tube	10	DCG85X1200NA

Equivalent Circuits for Simulation *on die level, typical

		$T_{VJ} = 125^\circ\text{C}$	$T_{VJ} = 175^\circ\text{C}$	
$I \rightarrow$				
$V_{0 \max}$	threshold voltage	0.80	0.73	V
$R_{0 \max}$	slope resistance *	28.4	35.2	mΩ

Outlines SOT-227B (minibloc)


Dim.	Millimeter		Inches	
	min	max	min	max
A	31.50	31.88	1.240	1.255
B	7.80	8.20	0.307	0.323
C	4.09	4.29	0.161	0.169
D	4.09	4.29	0.161	0.169
E	4.09	4.29	0.161	0.169
F	14.91	15.11	0.587	0.595
G	30.12	30.30	1.186	1.193
H	37.80	38.23	1.488	1.505
J	11.68	12.22	0.460	0.481
K	8.92	9.60	0.351	0.378
L	0.74	0.84	0.029	0.033
M	12.50	13.10	0.492	0.516
N	25.15	25.42	0.990	1.001
O	1.95	2.13	0.077	0.084
P	4.95	6.20	0.195	0.244
Q	26.54	26.90	1.045	1.059
R	3.94	4.42	0.155	0.167
S	4.55	4.85	0.179	0.191
T	24.59	25.25	0.968	0.994
U	-0.05	0.10	-0.002	0.004
V	3.20	5.50	0.126	0.217
W	19.81	21.08	0.780	0.830
Z	2.50	2.70	0.098	0.106



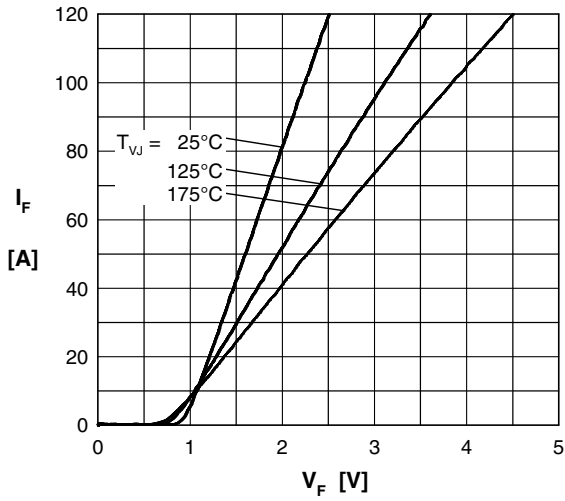
SiC Diode (per leg)


Fig. 1 Typ. forward characteristics

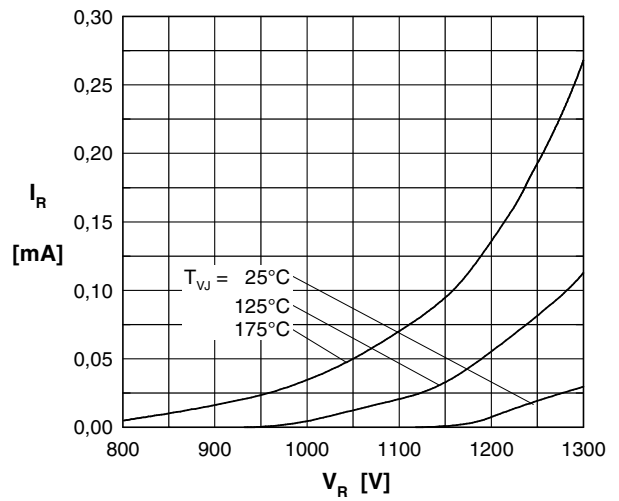


Fig. 2 Typ. reverse characteristics

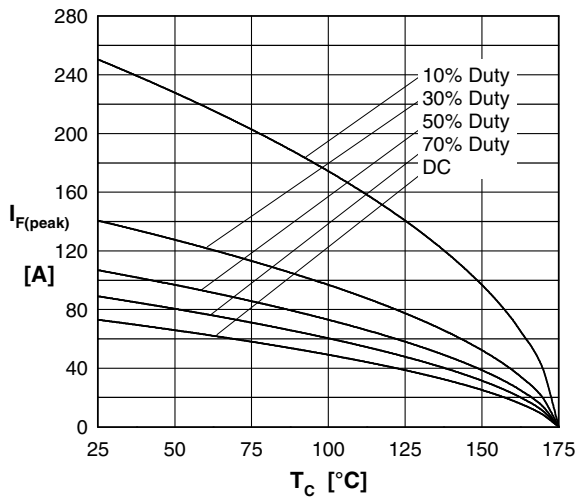


Fig. 3 Typ. current derating

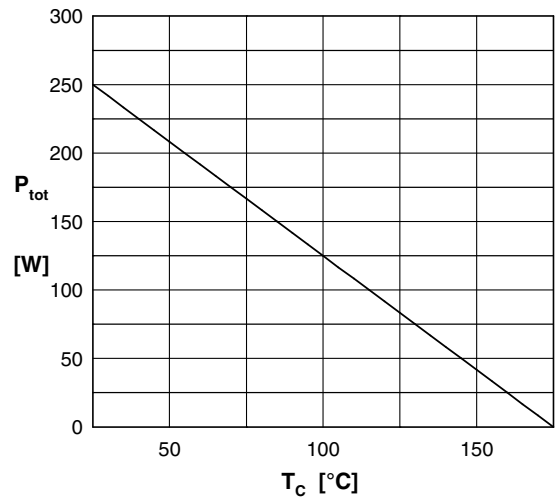


Fig. 4 Power derating

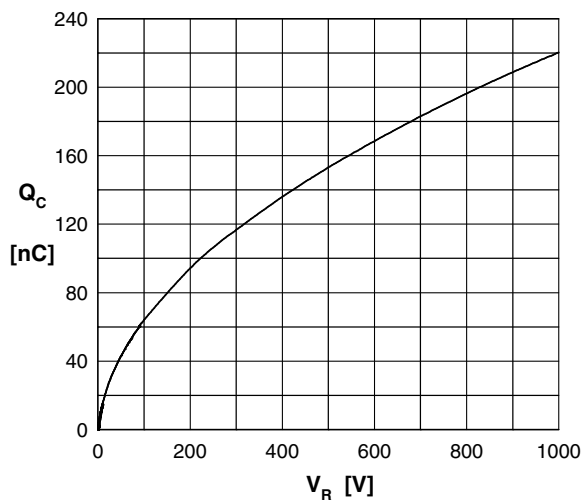


Fig. 5 Typ. recovery charge vs. reverse voltage

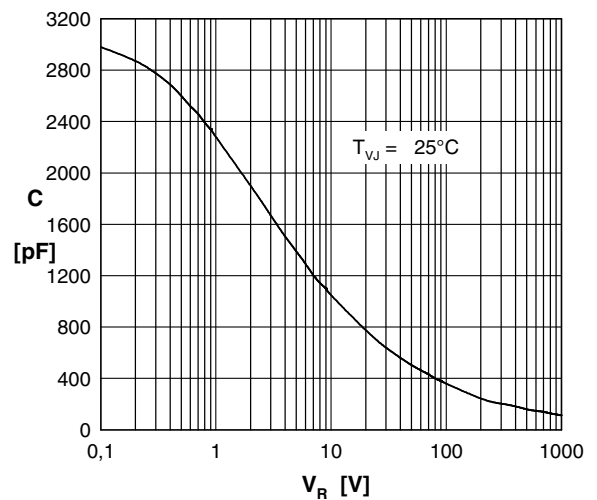


Fig. 6 Typ. junction capacitance vs. reverse Voltage

IXYS reserves the right to change limits, test conditions and dimensions.

20220608b

SiC Diode (per leg)

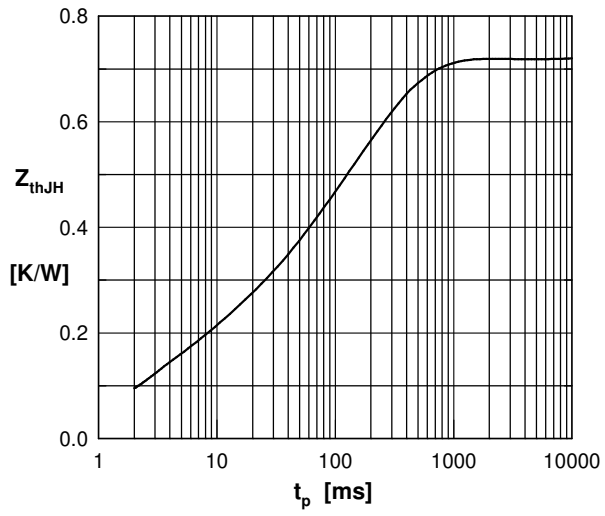


Fig. 7 Typ. transient thermal impedance