



FRED

| | | |
|-----------|---|-------|
| V_{RRM} | = | 600 V |
| I_{FAV} | = | 25 A |
| t_{rr} | = | 35 ns |

Fast Recovery Epitaxial Diode Single Diode

Part number

DFE25I600HA

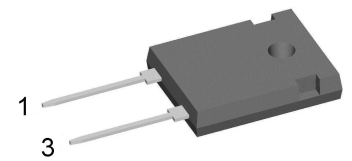

Backside: cathode



Features / Advantages:

- Planar passivated chips
- Low leakage current
- Very short recovery time
- Improved thermal behaviour
- Very low I_{rm} -values
- Very soft recovery behaviour
- Avalanche voltage rated for reliable operation
- Soft reverse recovery for low EMI/RFI
- Low I_{rm} reduces:
 - Power dissipation within the diode
 - Turn-on loss in the commutating switch

Applications:

- Antiparallel diode for high frequency switching devices
- Antisaturation diode
- Snubber diode
- Free wheeling diode
- Rectifiers in switch mode power supplies (SMPS)
- Uninterruptible power supplies (UPS)

Package: TO-247

- Industry standard outline
- RoHS compliant
- Epoxy meets UL 94V-0
- Soldering pins for PCB mounting
- Base plate: Plastic overmolded tab
- Reduced weight

Disclaimer Notice

Information furnished is believed to be accurate and reliable. However, users should independently evaluate the suitability of and test each product selected for their own applications. Littelfuse products are not designed for, and may not be used in, all applications. Read complete Disclaimer Notice at www.littelfuse.com/disclaimer-electronics.



| Fast Diode | | | | Ratings | | | |
|------------|--|---|-------------------------|---------|------|------------|--|
| Symbol | Definition | Conditions | min. | typ. | max. | Unit | |
| V_{RSM} | max. non-repetitive reverse blocking voltage | $T_{VJ} = 25^{\circ}C$ | | | 600 | V | |
| V_{RRM} | max. repetitive reverse blocking voltage | $T_{VJ} = 25^{\circ}C$ | | | 600 | V | |
| I_R | reverse current, drain current | $V_R = 600 V$ | $T_{VJ} = 25^{\circ}C$ | | 100 | μA | |
| | | $V_R = 480 V$ | $T_{VJ} = 125^{\circ}C$ | | 6 | mA | |
| V_F | forward voltage drop | $I_F = 25 A$ | $T_{VJ} = 25^{\circ}C$ | | 1.50 | V | |
| | | $I_F = 50 A$ | | | 1.77 | V | |
| | | $I_F = 25 A$ | $T_{VJ} = 150^{\circ}C$ | | 1.35 | V | |
| | | $I_F = 50 A$ | | | 1.72 | V | |
| I_{FAV} | average forward current | $T_C = 100^{\circ}C$ rectangular $d = 0.5$ | $T_{VJ} = 150^{\circ}C$ | | 25 | A | |
| V_{FO} | threshold voltage | } for power loss calculation only | $T_{VJ} = 150^{\circ}C$ | | 1.10 | V | |
| r_F | slope resistance | | | | 10 | m Ω | |
| R_{thJC} | thermal resistance junction to case | | | | 1.2 | K/W | |
| R_{thCH} | thermal resistance case to heatsink | | | 0.25 | | K/W | |
| P_{tot} | total power dissipation | | $T_C = 25^{\circ}C$ | | 105 | W | |
| I_{FSM} | max. forward surge current | $t = 10 ms; (50 Hz), sine; V_R = 0 V$ | $T_{VJ} = 45^{\circ}C$ | | 240 | A | |
| C_J | junction capacitance | $V_R = 400 V$ $f = 1 MHz$ | $T_{VJ} = 25^{\circ}C$ | | 20 | pF | |
| I_{RM} | max. reverse recovery current | } $I_F = 30 A; V_R = 300 V$ $-di_F/dt = 200 A/\mu s$ | $T_{VJ} = 25^{\circ}C$ | | 9 | A | |
| | | | $T_{VJ} = 100^{\circ}C$ | | 14 | A | |
| t_{rr} | reverse recovery time | | $T_{VJ} = 25^{\circ}C$ | | 50 | ns | |
| | | | $T_{VJ} = 100^{\circ}C$ | | 120 | ns | |

| Package TO-247 | | | Ratings | | | |
|----------------|------------------------------|--------------|---------|------|------|------|
| Symbol | Definition | Conditions | min. | typ. | max. | Unit |
| I_{RMS} | RMS current | per terminal | | | 50 | A |
| T_{VJ} | virtual junction temperature | | -55 | | 150 | °C |
| T_{op} | operation temperature | | -55 | | 125 | °C |
| T_{stg} | storage temperature | | -55 | | 150 | °C |
| Weight | | | | 6 | | g |
| M_D | mounting torque | | 0.8 | | 1.2 | Nm |
| F_C | mounting force with clip | | 20 | | 120 | N |

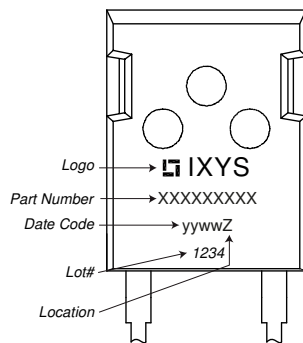
Product Marking

Part description

D = Diode
 F = FRED
 E = fast, low VF
 25 = Current Rating [A]
 I = Single Diode
 600 = Reverse Voltage [V]
 HA = TO-247AD (2)

| Ordering | Ordering Number | Marking on Product | Delivery Mode | Quantity | Code No. |
|----------|-----------------|--------------------|---------------|----------|----------|
| Standard | DFE25I600HA | DFE25I600HA | Tube | 30 | 521189 |

| Similar Part | Package | Voltage class |
|--------------|----------------------|---------------|
| DSEI25-06A | TO-220AC (2) | 600 |
| DSEI25-06AS | TO-263AB (D2Pak) (2) | 600 |

Equivalent Circuits for Simulation

* on die level

 $T_{VJ} = 150^{\circ}\text{C}$

Fast Diode

| | | | |
|--------------|--------------------|-----|----|
| $V_{0\ max}$ | threshold voltage | 1.1 | V |
| $R_{0\ max}$ | slope resistance * | 7.5 | mΩ |



Outlines TO-247



| Sym. | Inches | | Millimeter | |
|------|-----------|-------|------------|-------|
| | min. | max. | min. | max. |
| A | 0.185 | 0.209 | 4.70 | 5.30 |
| A1 | 0.087 | 0.102 | 2.21 | 2.59 |
| A2 | 0.059 | 0.098 | 1.50 | 2.49 |
| D | 0.819 | 0.845 | 20.79 | 21.45 |
| E | 0.610 | 0.640 | 15.48 | 16.24 |
| E2 | 0.170 | 0.216 | 4.31 | 5.48 |
| e | 0.430 BSC | | 10.92 BSC | |
| L | 0.780 | 0.800 | 19.80 | 20.30 |
| L1 | - | 0.177 | - | 4.49 |
| Ø P | 0.140 | 0.144 | 3.55 | 3.65 |
| Q | 0.212 | 0.244 | 5.38 | 6.19 |
| S | 0.242 BSC | | 6.14 BSC | |
| b | 0.039 | 0.055 | 0.99 | 1.40 |
| b2 | 0.065 | 0.094 | 1.65 | 2.39 |
| b4 | 0.102 | 0.135 | 2.59 | 3.43 |
| c | 0.015 | 0.035 | 0.38 | 0.89 |
| D1 | 0.515 | - | 13.07 | - |
| D2 | 0.020 | 0.053 | 0.51 | 1.35 |
| E1 | 0.530 | - | 13.45 | - |
| Ø P1 | - | 0.29 | - | 7.39 |



Fast Diode

 Fig. 1 Forward current I_F versus max. forward voltage drop V_F

 Fig. 2 Typ. reverse recov. charge Q_r versus $-di_F/dt$

 Fig. 3 Typ. peak reverse current I_{RM} versus $-di_F/dt$

 Fig. 4 Dynamic parameters Q_r , I_{RM} versus T_{VJ}

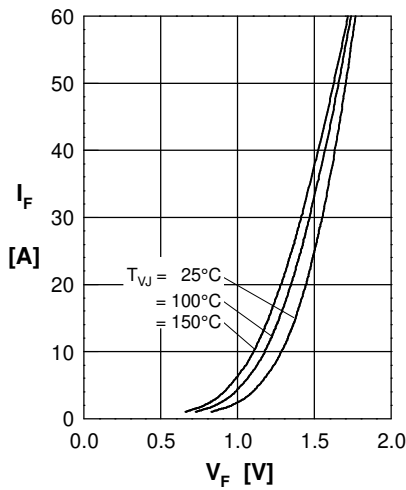
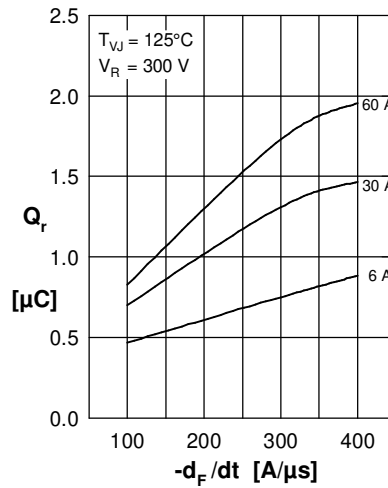
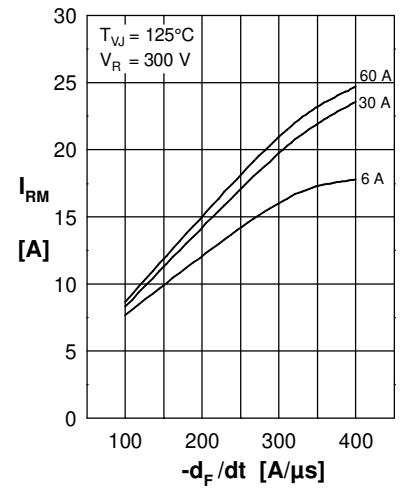
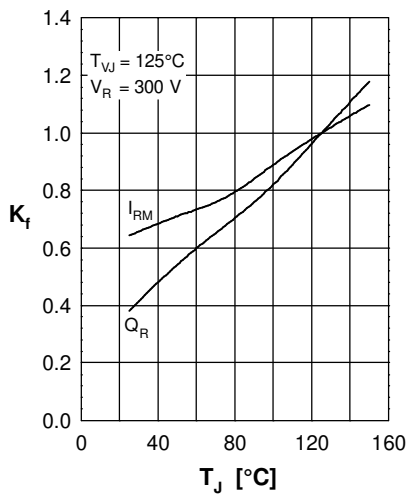
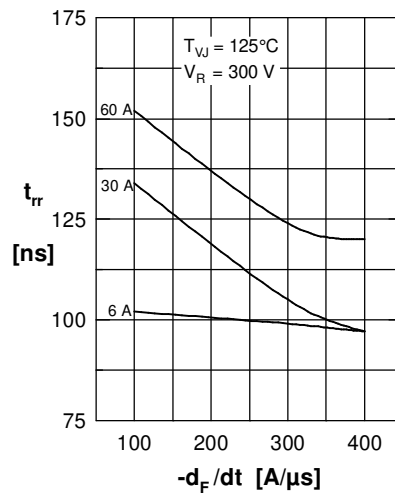
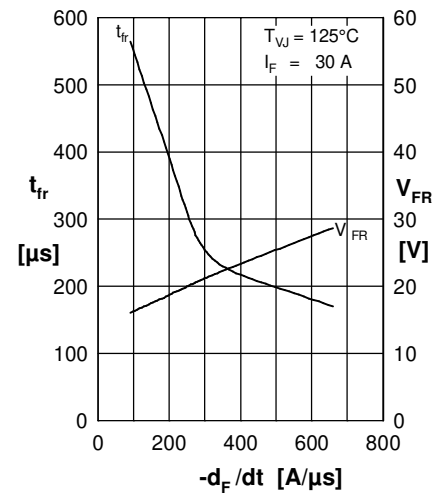
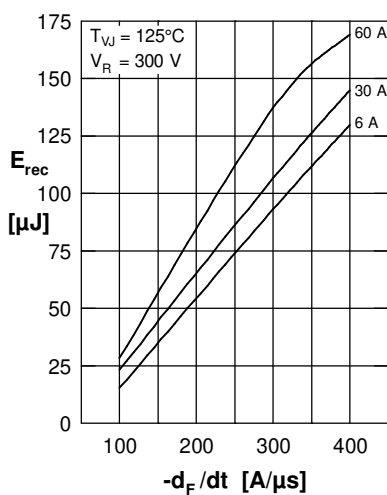
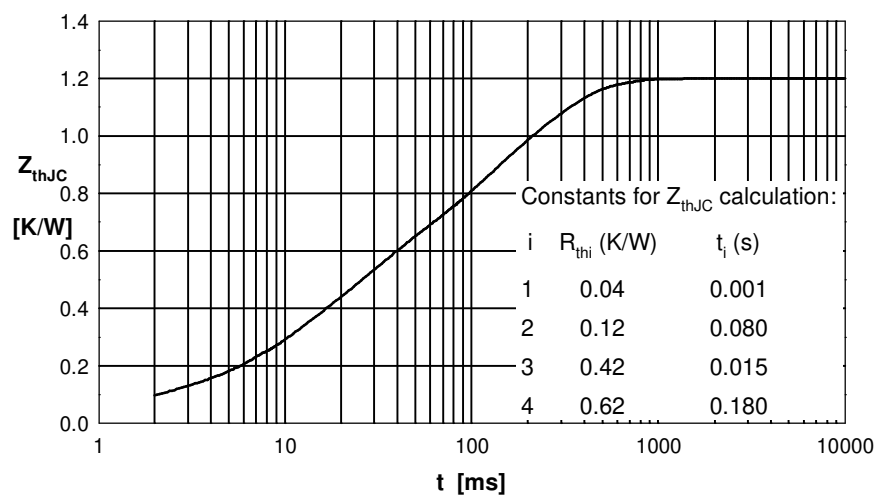
 Fig. 5 Typ. recovery time t_{rr} versus $-di_F/dt$

 Fig. 6 Typ. peak forward voltage V_{FR} and t_{fr} versus di_F/dt

 Fig. 7 Recovery energy E_{rec} versus $-di_F/dt$

Fig. 8 Transient thermal impedance junction to case