

# Sonic Fast Recovery Diode

$V_{RRM} = 2 \times 1800 \text{ V}$   
 $I_{FAV} = 60 \text{ A}$   
 $t_{rr} = 230 \text{ ns}$

High Performance Fast Recovery Diode  
 Low Loss and Soft Recovery  
 Phase leg

Part number

**DHH55-36N1F**

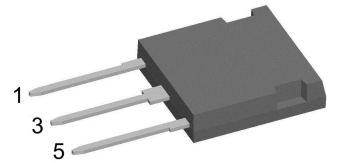

Backside: Isolated

 E72873

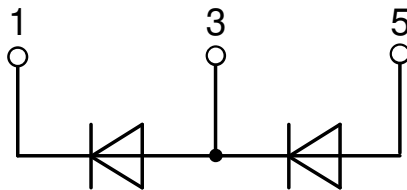

## Features / Advantages:

- Planar passivated chips
- Very low leakage current
- Very short recovery time
- Improved thermal behaviour
- Very low  $I_{rm}$ -values
- Very soft recovery behaviour
- Avalanche voltage rated for reliable operation
- Soft reverse recovery for low EMI/RFI
- Low  $I_{rm}$  reduces:
  - Power dissipation within the diode
  - Turn-on loss in the commutating switch

## Applications:

- Antiparallel diode for high frequency switching devices
- Antisaturation diode
- Snubber diode
- Free wheeling diode
- Rectifiers in switch mode power supplies (SMPS)
- Uninterruptible power supplies (UPS)

## Package: i4-Pac

- Isolation Voltage: 3000 V~
- Industry convenient outline
- RoHS compliant
- Epoxy meets UL 94V-0
- Soldering pins for PCB mounting
- Backside: DCB ceramic
- Reduced weight
- Advanced power cycling

## Disclaimer Notice

Information furnished is believed to be accurate and reliable. However, users should independently evaluate the suitability of and test each product selected for their own applications. Littelfuse products are not designed for, and may not be used in, all applications. Read complete Disclaimer Notice at [www.littelfuse.com/disclaimer-electronics](http://www.littelfuse.com/disclaimer-electronics).



Fast Diode				Ratings			
Symbol	Definition	Conditions	min.	typ.	max.	Unit	
$V_{RSM}$	max. non-repetitive reverse blocking voltage	$T_{VJ} = 25^{\circ}C$			1800	V	
$V_{RRM}$	max. repetitive reverse blocking voltage	$T_{VJ} = 25^{\circ}C$			1800	V	
$I_R$	reverse current, drain current	$V_R = 1800 V$	$T_{VJ} = 25^{\circ}C$		200	$\mu A$	
		$V_R = 1800 V$	$T_{VJ} = 125^{\circ}C$		2	mA	
$V_F$	forward voltage drop	$I_F = 60 A$	$T_{VJ} = 25^{\circ}C$		2.04	V	
		$I_F = 120 A$			2.57	V	
		$I_F = 60 A$	$T_{VJ} = 125^{\circ}C$		2.03	V	
		$I_F = 120 A$			2.73	V	
$I_{FAV}$	average forward current	$T_C = 50^{\circ}C$ rectangular $d = 0.5$	$T_{VJ} = 150^{\circ}C$		60	A	
$V_{FO}$	threshold voltage	} for power loss calculation only	$T_{VJ} = 150^{\circ}C$		1.28	V	
$r_F$	slope resistance				12	m $\Omega$	
$R_{thJC}$	thermal resistance junction to case				0.6	K/W	
$R_{thCH}$	thermal resistance case to heatsink			0.2		K/W	
$P_{tot}$	total power dissipation		$T_C = 25^{\circ}C$		210	W	
$I_{FSM}$	max. forward surge current	$t = 10 ms; (50 Hz), sine; V_R = 0 V$	$T_{VJ} = 45^{\circ}C$		700	A	
$C_J$	junction capacitance	$V_R = 1200 V \quad f = 1 MHz$	$T_{VJ} = 25^{\circ}C$		28	pF	
$I_{RM}$	max. reverse recovery current	} $I_F = 60 A; V_R = 1200 V$ $-di_F/dt = 800 A/\mu s$	$T_{VJ} = 25^{\circ}C$		60	A	
			$T_{VJ} = 100^{\circ}C$		70	A	
$t_{rr}$	reverse recovery time		$T_{VJ} = 25^{\circ}C$		230	ns	
			$T_{VJ} = 100^{\circ}C$		350	ns	



Package i4-Pac		Ratings				
Symbol	Definition	Conditions	min.	typ.	max.	Unit
$I_{RMS}$	RMS current	per terminal			70	A
$T_{VJ}$	virtual junction temperature		-55		150	°C
$T_{op}$	operation temperature		-55		125	°C
$T_{stg}$	storage temperature		-55		150	°C
<b>Weight</b>				5.5		g
$F_C$	mounting force with clip		20		120	N
$d_{Spp/ App}$	creepage distance on surface   striking distance through air	terminal to terminal	5.5			mm
$d_{Spb/ Apb}$		terminal to backside	5.1			mm
$V_{ISOL}$	isolation voltage	t = 1 second	3000			V
		t = 1 minute	2500			V

**Product Marking**

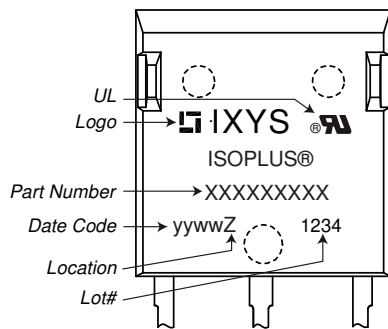

Ordering	Ordering Number	Marking on Product	Delivery Mode	Quantity	Code No.
Standard	DHH55-36N1F	DHH55-36N1F	Tube	25	500173

**Equivalent Circuits for Simulation**

\* on die level

$T_{VJ} = 150^{\circ}C$



**Fast Diode**

$V_{0\ max}$	threshold voltage	1.28	V
$R_{0\ max}$	slope resistance *	9.5	mΩ



**Outlines i4-Pac**

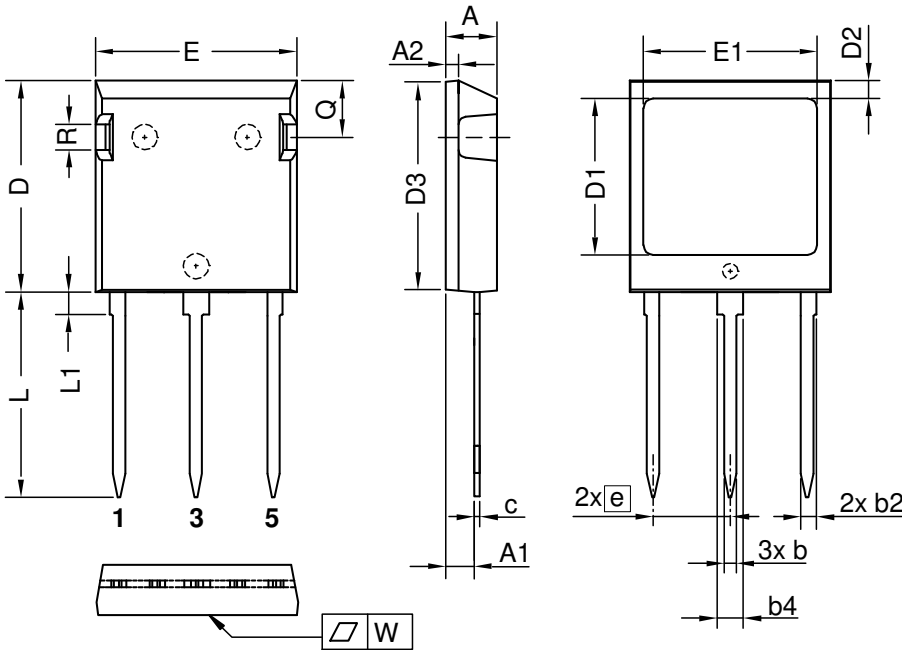

Dim.	Millimeter		Inches	
	min	max	min	max
A	4.83	5.21	0.190	0.205
A1	2.59	3.00	0.102	0.118
A2	1.17	2.16	0.046	0.085
b	1.14	1.40	0.045	0.055
b2	1.47	1.73	0.058	0.068
b4	2.54	2.79	0.100	0.110
c	0.51	0.74	0.020	0.029
D	20.80	21.34	0.819	0.840
D1	14.99	15.75	0.590	0.620
D2	1.65	2.03	0.065	0.080
D3	20.30	20.70	0.799	0.815
E	19.56	20.29	0.770	0.799
E1	16.76	17.53	0.660	0.690
e	7.62 BSC		0.300 BSC	
L	19.81	21.34	0.780	0.840
L1	2.11	2.59	0.083	0.102
Q	5.33	6.20	0.210	0.244
R	2.54	4.57	0.100	0.180
W	-	0.10	-	0.004

Die konvexe Form des Substrates ist typ. < 0.05 mm über der Kunststoffoberfläche der Bauteilunterseite  
The convex bow of substrate is typ. < 0.05 mm over plastic surface level of device bottom side

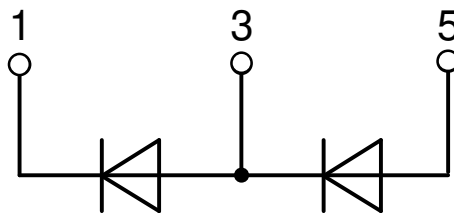



**Fast Diode**

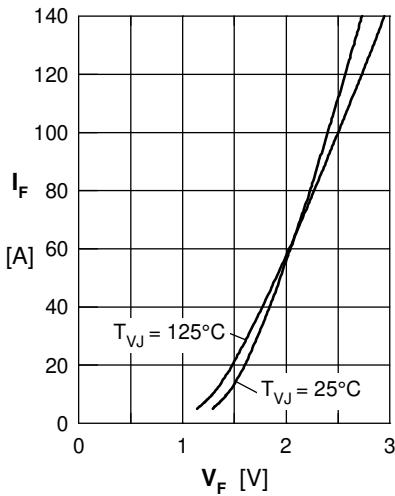

Fig. 1 Typ. rward current  $I_F$  versus  $V_F$

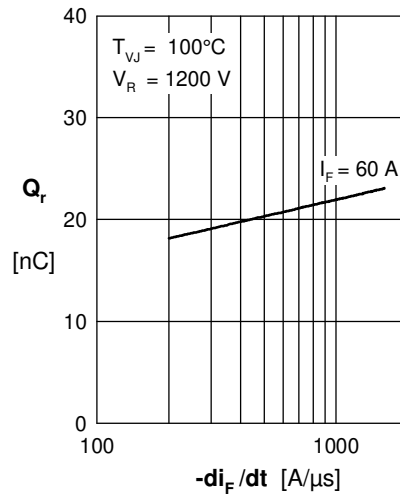

Fig. 2 Typ. reverse recovery charge  $Q_r$  versus  $-di_F/dt$

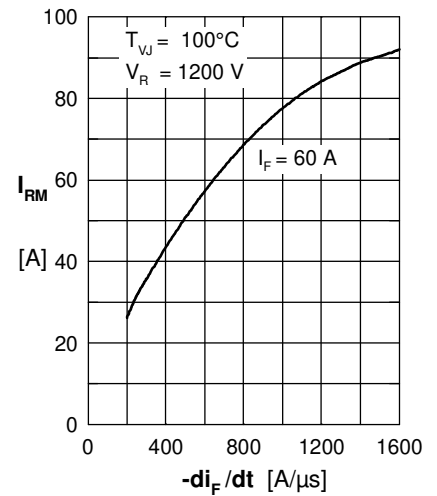

Fig. 3 Typ. peak reverse current  $I_{RM}$  versus  $-di_F/dt$

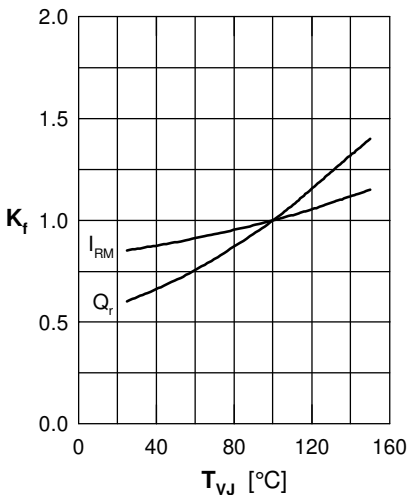

Fig. 4 Dynamic parameters  $Q_r$ ,  $I_{RM}$  versus  $T_{VJ}$

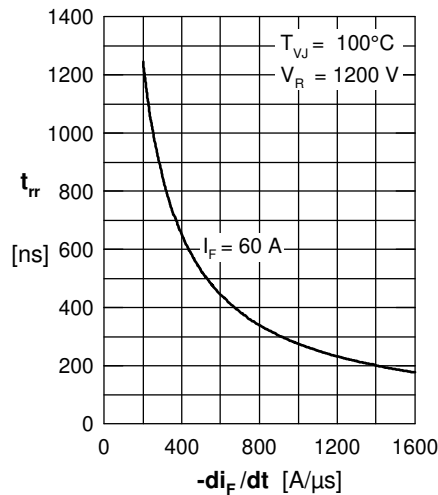

Fig. 5 Typ. recovery time  $t_{rr}$  versus  $-di_F/dt$

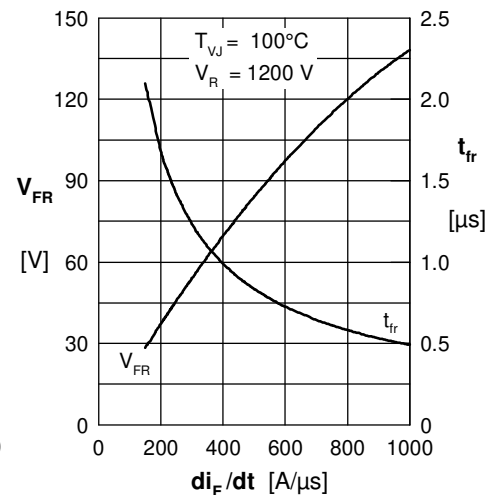

Fig. 6 Typ. peak forward voltage  $V_{FR}$  & typ. forward recovery time  $t_{fr}$  versus  $di_F/dt$

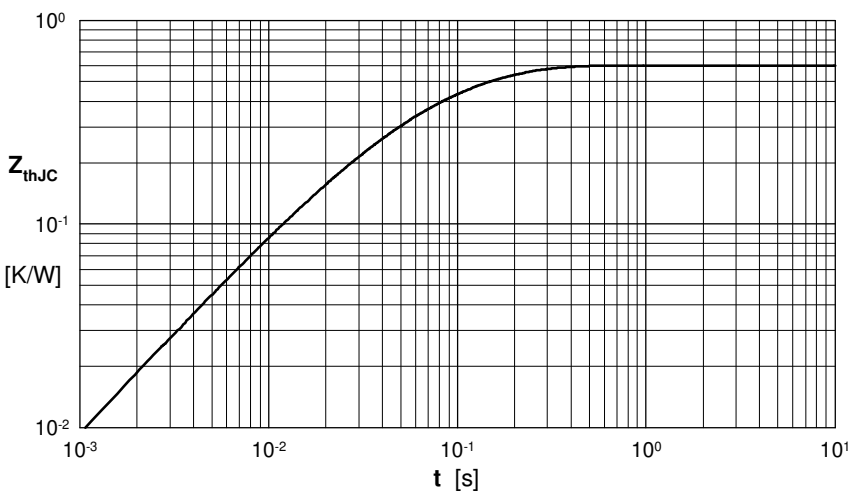

Fig. 7 Transient thermal resistance junction to case

Constants for  $Z_{thJC}$  calculation:

i	$R_{thi}$ (K/W)	$t_i$ (s)
1	0.212	0.0055
2	0.248	0.0092
3	0.063	0.0007
4	0.077	0.0391