

Standard Rectifier

$$V_{RRM} = 2 \times 1600 \text{ V}$$

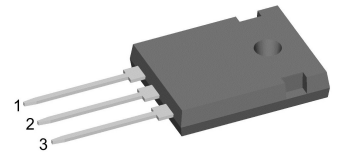
$$I_{FAV} = 10 \text{ A}$$

$$V_F = 1.18 \text{ V}$$

Phase leg

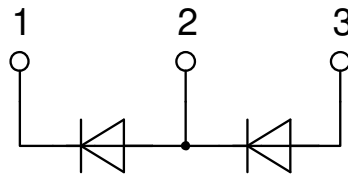
Part number

DMA10P1600HR



Backside: isolated

 E72873



Features / Advantages:

- Planar passivated chips
- Very low leakage current
- Very low forward voltage drop
- Improved thermal behaviour

Applications:

- Diode for main rectification
- For single and three phase bridge configurations

Package: ISO247

- Isolation Voltage: 3600 V~
- Industry standard outline
- RoHS compliant
- Epoxy meets UL 94V-0
- Soldering pins for PCB mounting
- Backside: DCB ceramic
- Reduced weight
- Advanced power cycling

Disclaimer Notice

Information furnished is believed to be accurate and reliable. However, users should independently evaluate the suitability of and test each product selected for their own applications. Littelfuse products are not designed for, and may not be used in, all applications. Read complete Disclaimer Notice at www.littelfuse.com/disclaimer-electronics.

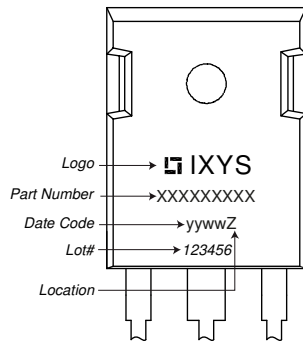


Rectifier				Ratings			
Symbol	Definition	Conditions	min.	typ.	max.	Unit	
V_{RSM}	max. non-repetitive reverse blocking voltage				1700	V	
V_{RRM}	max. repetitive reverse blocking voltage				1600	V	
I_R	reverse current	$V_R = 1600$ V			10	μ A	
		$V_R = 1600$ V			0.2	mA	
V_F	forward voltage drop	$I_F = 10$ A			1.23	V	
		$I_F = 20$ A			1.46	V	
		$I_F = 10$ A	$T_{VJ} = 150^\circ\text{C}$			1.18	V
		$I_F = 20$ A	$T_{VJ} = 150^\circ\text{C}$			1.49	V
I_{FAV}	average forward current	$T_C = 145^\circ\text{C}$ rectangular			10	A	
V_{F0}	threshold voltage	} for power loss calculation only			0.81	V	
r_F	slope resistance				34	m Ω	
R_{thJC}	thermal resistance junction to case				2	K/W	
R_{thCH}	thermal resistance case to heatsink			0.3		K/W	
P_{tot}	total power dissipation				75	W	
I_{FSM}	max. forward surge current	t = 10 ms; (50 Hz), sine	$T_{VJ} = 45^\circ\text{C}$		120	A	
		t = 8,3 ms; (60 Hz), sine	$V_R = 0$ V		130	A	
		t = 10 ms; (50 Hz), sine	$T_{VJ} = 150^\circ\text{C}$		100	A	
		t = 8,3 ms; (60 Hz), sine	$V_R = 0$ V		110	A	
I^2t	value for fusing	t = 10 ms; (50 Hz), sine	$T_{VJ} = 45^\circ\text{C}$		72	A ² s	
		t = 8,3 ms; (60 Hz), sine	$V_R = 0$ V		70	A ² s	
		t = 10 ms; (50 Hz), sine	$T_{VJ} = 150^\circ\text{C}$		50	A ² s	
		t = 8,3 ms; (60 Hz), sine	$V_R = 0$ V		50	A ² s	
C_J	junction capacitance	$V_R = 400$ V; f = 1 MHz	$T_{VJ} = 25^\circ\text{C}$		4	pF	



Package ISO247		Ratings				
Symbol	Definition	Conditions	min.	typ.	max.	Unit
I_{RMS}	RMS current	per terminal			70	A
T_{VJ}	virtual junction temperature		-55		175	°C
T_{op}	operation temperature		-55		150	°C
T_{stg}	storage temperature		-55		150	°C
Weight				6		g
M_D	mounting torque		0.8		1.2	Nm
F_C	mounting force with clip		20		120	N
$d_{Spp/App}$	creepage distance on surface striking distance through air	terminal to terminal	2.7			mm
$d_{Spb/Apb}$		terminal to backside	4.1			mm
V_{ISOL}	isolation voltage	t = 1 second	3600			V
		t = 1 minute	3000			V

Product Marking



Part description

- D = Diode
- M = Standard Rectifier
- A = (up to 1800V)
- 10 = Current Rating [A]
- P = Phase leg
- 1600 = Reverse Voltage [V]
- HR = ISO247 (3)

Ordering	Ordering Number	Marking on Product	Delivery Mode	Quantity	Code No.
Standard	DMA10P1600HR	DMA10P1600HR	Tube	30	522535

Similar Part	Package	Voltage class
DMA10P1200HR	ISO247 (3)	1200

Equivalent Circuits for Simulation

* on die level

$T_{VJ} = 175^{\circ}C$

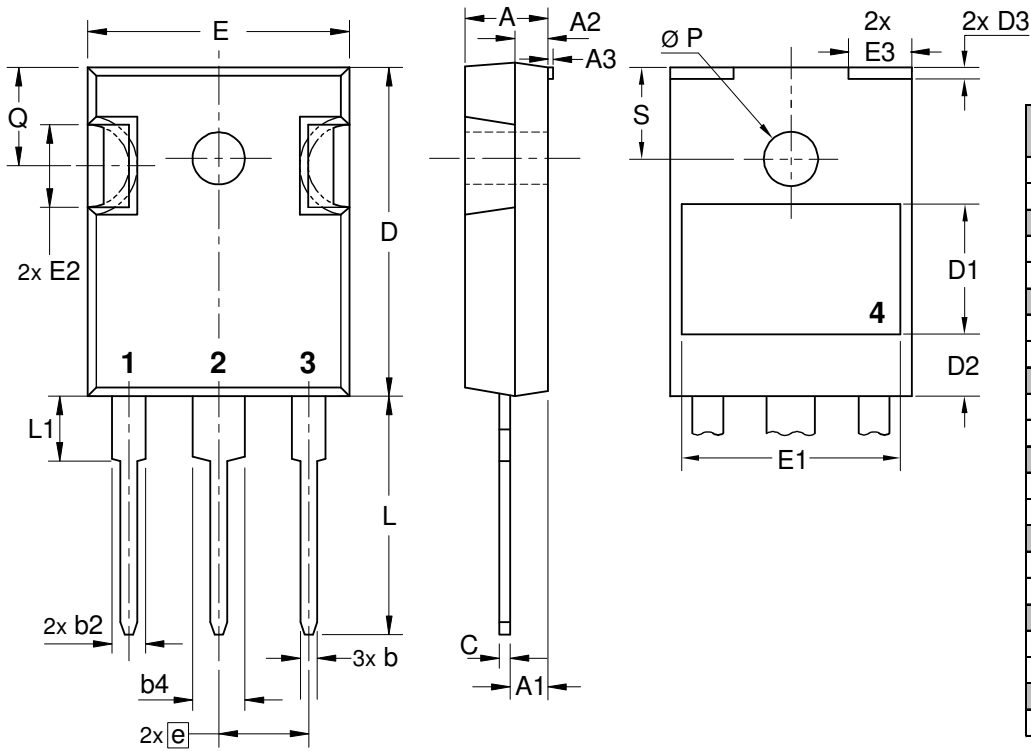


Rectifier

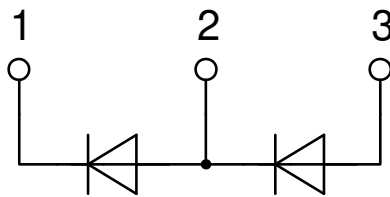
$V_{0 \max}$	threshold voltage	0.81	V
$R_{0 \max}$	slope resistance *	31	mΩ



Outlines ISO247



Dim.	Millimeter		Inches	
	min	max	min	max
A	4.70	5.30	0.185	0.209
A1	2.21	2.59	0.087	0.102
A2	1.50	2.49	0.059	0.098
A3	typ. 0.05		typ. 0.002	
b	0.99	1.40	0.039	0.055
b2	1.65	2.39	0.065	0.094
b4	2.59	3.43	0.102	0.135
c	0.38	0.89	0.015	0.035
D	20.79	21.45	0.819	0.844
D1	typ. 8.90		typ. 0.350	
D2	typ. 2.90		typ. 0.114	
D3	typ. 1.00		typ. 0.039	
E	15.49	16.24	0.610	0.639
E1	typ. 13.45		typ. 0.530	
E2	4.31	5.48	0.170	0.216
E3	typ. 4.00		typ. 0.157	
e	5.46 BSC		0.215 BSC	
L	19.80	20.30	0.780	0.799
L1	-	4.49	-	0.177
Ø P	3.55	3.65	0.140	0.144
Q	5.38	6.19	0.212	0.244
S	6.14 BSC		0.242 BSC	



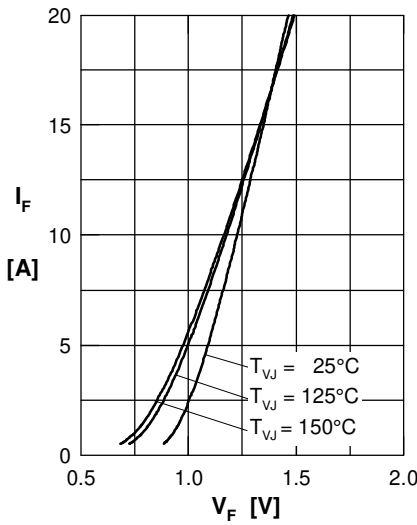
Rectifier


Fig. 1 Forward current versus voltage drop per diode

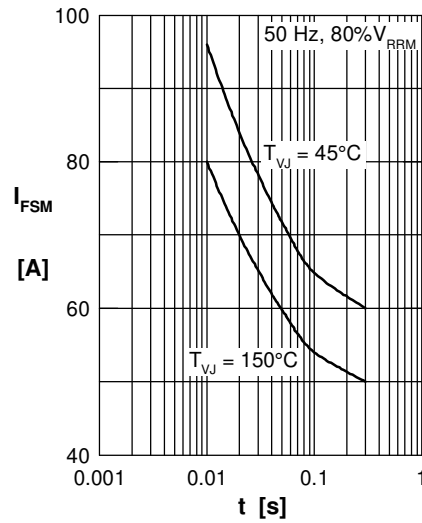


Fig. 2 Surge overload current

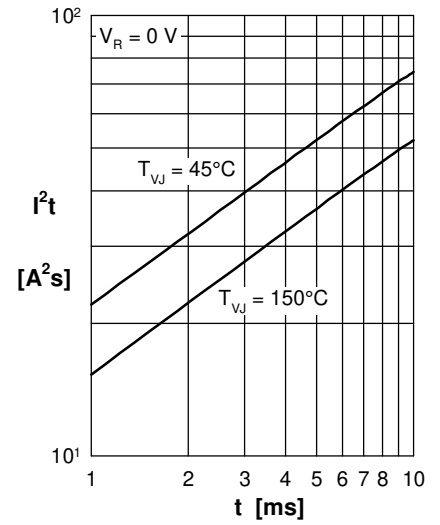
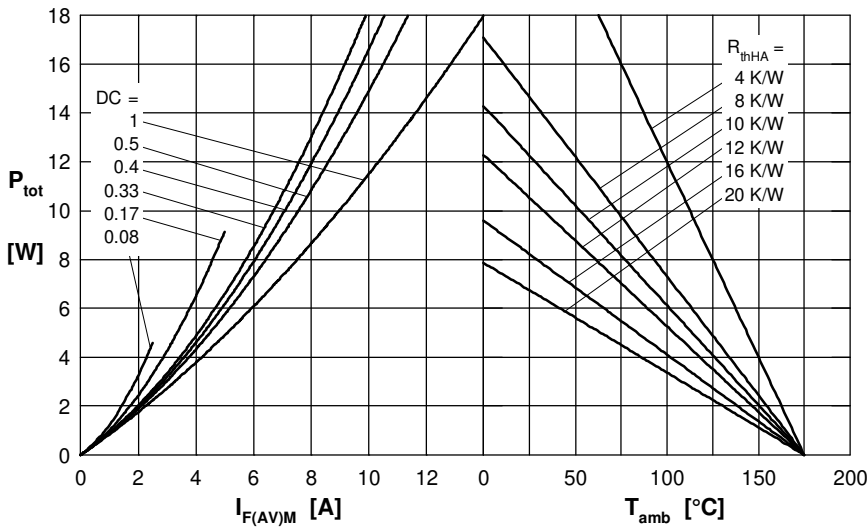

 Fig. 3 I^2t versus time per diode


Fig. 4 Power dissipation vs. direct output current and ambient temperature

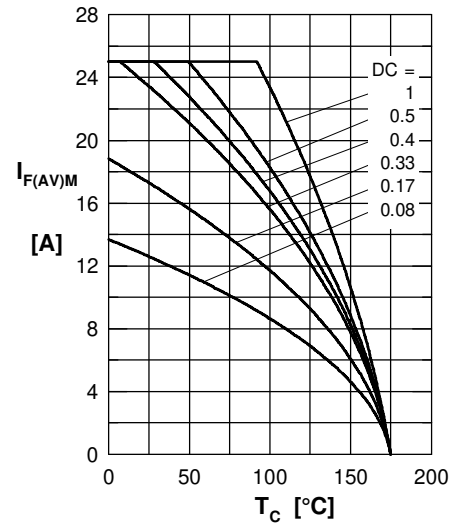


Fig. 5 Max. forward current vs. case temperature

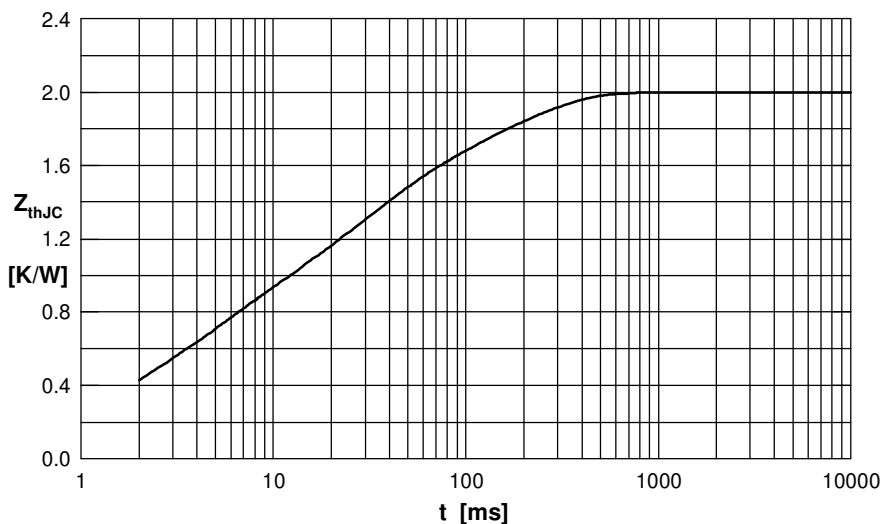


Fig. 6 Transient thermal impedance junction to case

 Constants for Z_{thJC} calculation:

i	R_{thi} (K/W)	t_i (s)
1	0.06	0.0004
2	0.23	0.0020
3	0.40	0.0040
4	0.71	0.0240
5	0.60	0.1500