



Standard Rectifier

$$V_{RRM} = 1200\text{ V}$$

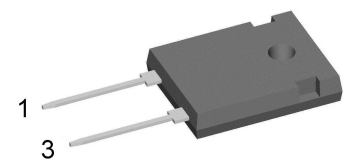
$$I_{FAV} = 50\text{ A}$$

$$V_F = 1.26\text{ V}$$

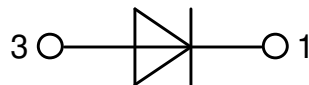
Single Diode

Part number

DMA50I1200HA



Backside: cathode



Features / Advantages:

- Planar passivated chips
- Very low leakage current
- Very low forward voltage drop
- Improved thermal behaviour
- High commutation robustness
- High surge capability

Applications:

- Diode for main rectification
- For single and three phase bridge configurations

Package: TO-247

- Industry standard outline
- RoHS compliant
- Epoxy meets UL 94V-0

Disclaimer Notice

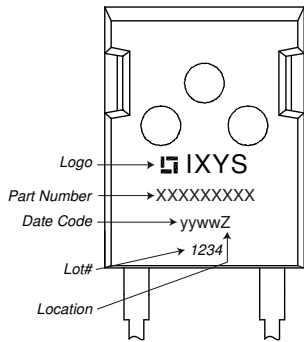
Information furnished is believed to be accurate and reliable. However, users should independently evaluate the suitability of and test each product selected for their own applications. Littelfuse products are not designed for, and may not be used in, all applications. Read complete Disclaimer Notice at www.littelfuse.com/disclaimer-electronics.

Rectifier				Ratings			
Symbol	Definition	Conditions	min.	typ.	max.	Unit	
V_{RSM}	max. non-repetitive reverse blocking voltage	$T_{VJ} = 25^{\circ}C$			1300	V	
V_{RRM}	max. repetitive reverse blocking voltage	$T_{VJ} = 25^{\circ}C$			1200	V	
I_R	reverse current	$V_R = 1200\text{ V}$	$T_{VJ} = 25^{\circ}C$		40	μA	
		$V_R = 1200\text{ V}$	$T_{VJ} = 150^{\circ}C$		1.5	mA	
V_F	forward voltage drop	$I_F = 50\text{ A}$	$T_{VJ} = 25^{\circ}C$		1.30	V	
					1.61	V	
		$I_F = 100\text{ A}$	$T_{VJ} = 150^{\circ}C$		1.26	V	
					1.66	V	
I_{FAV}	average forward current	$T_C = 130^{\circ}C$ 180° sine	$T_{VJ} = 175^{\circ}C$		50	A	
V_{FO}	threshold voltage	} for power loss calculation only	$T_{VJ} = 175^{\circ}C$		0.81	V	
r_F	slope resistance				8.6	m Ω	
R_{thJC}	thermal resistance junction to case				0.45	K/W	
R_{thCH}	thermal resistance case to heatsink			0.3		K/W	
P_{tot}	total power dissipation		$T_C = 25^{\circ}C$		330	W	
I_{FSM}	max. forward surge current	$t = 10\text{ ms}; (50\text{ Hz}), \text{ sine}$	$T_{VJ} = 45^{\circ}C$		650	A	
		$t = 8,3\text{ ms}; (60\text{ Hz}), \text{ sine}$	$V_R = 0\text{ V}$		700	A	
		$t = 10\text{ ms}; (50\text{ Hz}), \text{ sine}$	$T_{VJ} = 150^{\circ}C$		555	A	
		$t = 8,3\text{ ms}; (60\text{ Hz}), \text{ sine}$	$V_R = 0\text{ V}$		595	A	
I^2t	value for fusing	$t = 10\text{ ms}; (50\text{ Hz}), \text{ sine}$	$T_{VJ} = 45^{\circ}C$		2.12	kA ² s	
		$t = 8,3\text{ ms}; (60\text{ Hz}), \text{ sine}$	$V_R = 0\text{ V}$		2.04	kA ² s	
		$t = 10\text{ ms}; (50\text{ Hz}), \text{ sine}$	$T_{VJ} = 150^{\circ}C$		1.54	kA ² s	
		$t = 8,3\text{ ms}; (60\text{ Hz}), \text{ sine}$	$V_R = 0\text{ V}$		1.48	kA ² s	
C_J	junction capacitance	$V_R = 400\text{ V}; f = 1\text{ MHz}$	$T_{VJ} = 25^{\circ}C$		19	pF	



Package TO-247			Ratings			
Symbol	Definition	Conditions	min.	typ.	max.	Unit
I_{RMS}	RMS current	per terminal			70	A
T_{VJ}	virtual junction temperature		-55		175	°C
T_{op}	operation temperature		-55		150	°C
T_{stg}	storage temperature		-55		150	°C
Weight				6		g
M_D	mounting torque		0.8		1.2	Nm
F_C	mounting force with clip		20		120	N

Product Marking



Part description

- D = Diode
- M = Standard Rectifier
- A = (up to 1800V)
- 50 = Current Rating [A]
- I = Single Diode
- 1200 = Reverse Voltage [V]
- HA = TO-247AD (2)

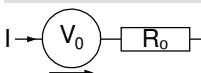
Ordering	Ordering Number	Marking on Product	Delivery Mode	Quantity	Code No.
Standard	DMA50I1200HA	DMA50I1200HA	Tube	30	522988

Similar Part	Package	Voltage class
DMA50I800HA	TO-247AD (2)	800
DMA50I1600HA	TO-247AD (2)	1600

Equivalent Circuits for Simulation

* on die level

$T_{VJ} = 175^{\circ}C$

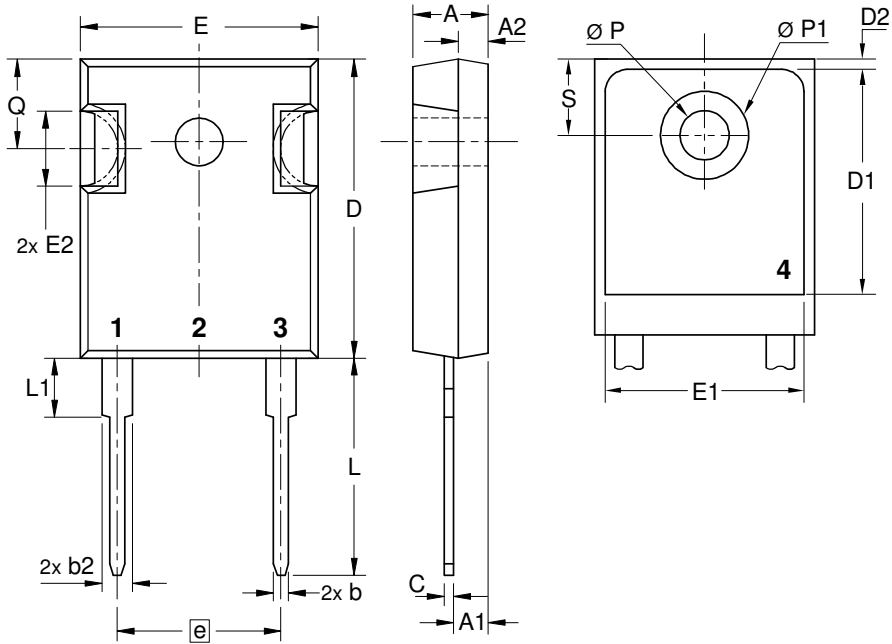


Rectifier

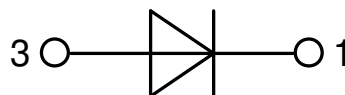
$V_{0\ max}$	threshold voltage	0.81	V
$R_{0\ max}$	slope resistance *	6	mΩ



Outlines TO-247



Sym.	Inches		Millimeter	
	min.	max.	min.	max.
A	0.185	0.209	4.70	5.30
A1	0.087	0.102	2.21	2.59
A2	0.059	0.098	1.50	2.49
D	0.819	0.845	20.79	21.45
E	0.610	0.640	15.48	16.24
E2	0.170	0.216	4.31	5.48
e	0.430 BSC		10.92 BSC	
L	0.780	0.800	19.80	20.30
L1	-	0.177	-	4.49
Ø P	0.140	0.144	3.55	3.65
Q	0.212	0.244	5.38	6.19
S	0.242 BSC		6.14 BSC	
b	0.039	0.055	0.99	1.40
b2	0.065	0.094	1.65	2.39
b4	0.102	0.135	2.59	3.43
c	0.015	0.035	0.38	0.89
D1	0.515	-	13.07	-
D2	0.020	0.053	0.51	1.35
E1	0.530	-	13.45	-
Ø P1	-	0.29	-	7.39



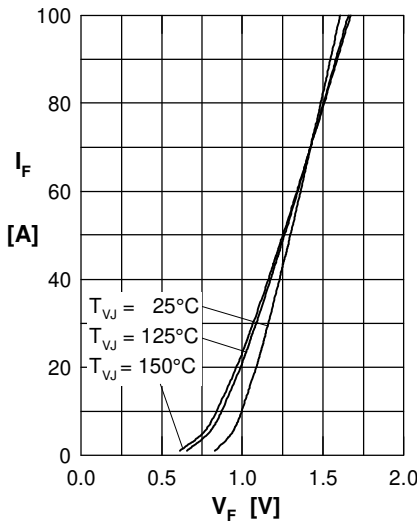
Rectifier


Fig. 1 Forward current versus voltage drop per diode

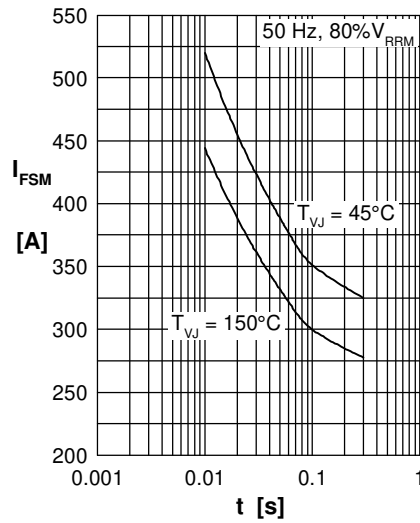


Fig. 2 Surge overload current versus time per diode

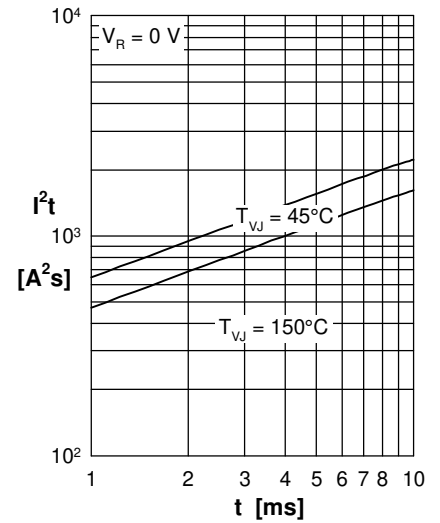
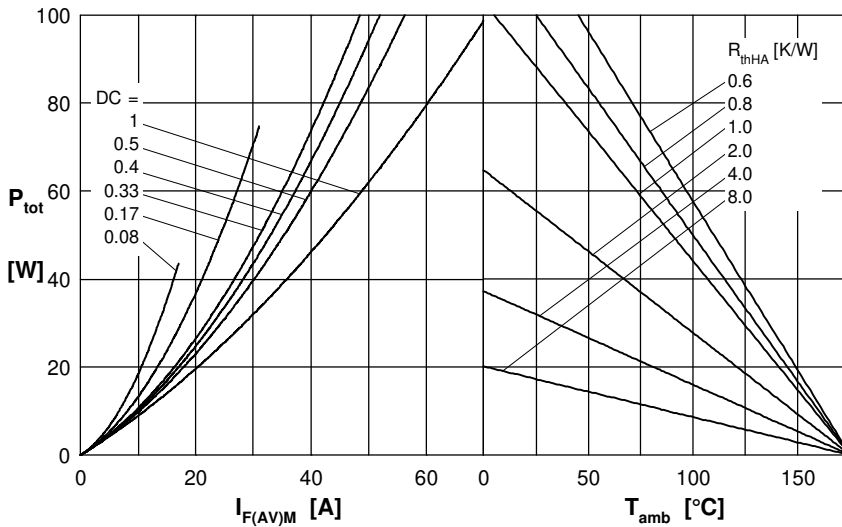

 Fig. 3 I^2t versus time per diode


Fig. 4 Power dissipation versus direct output current and ambient temperature per diode

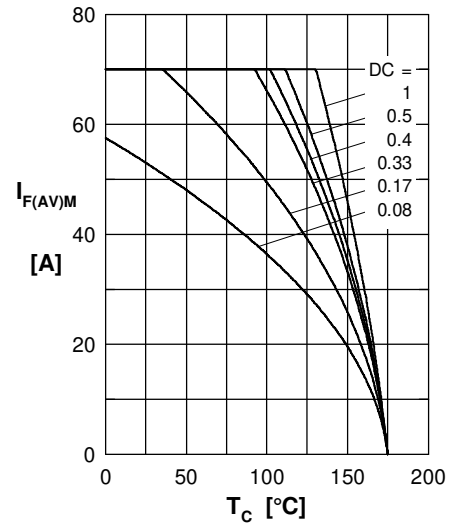


Fig. 5 Max. forward current versus case temperature per diode

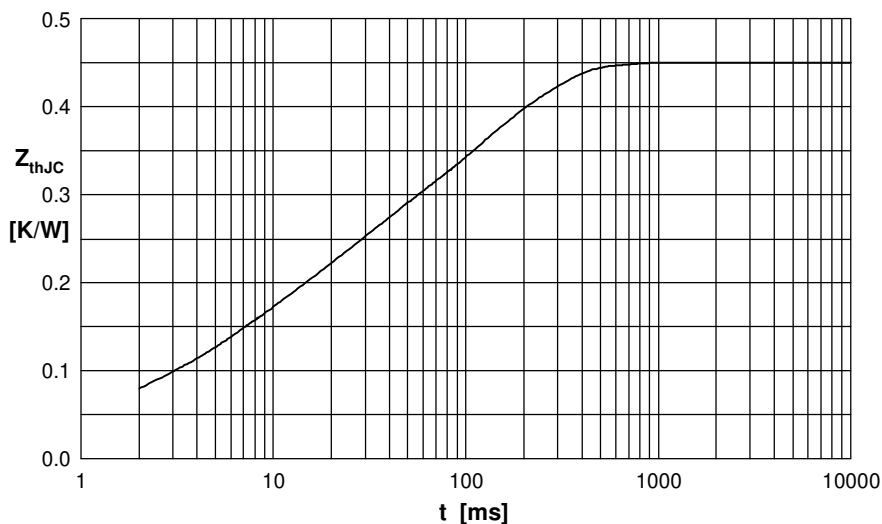


Fig. 6 Transient thermal impedance junction to case versus time per diode

 Constants for Z_{thJC} calculation:

i	R_{thi} (K/W)	t_i (s)
1	0.033	0.0006
2	0.075	0.0038
3	0.124	0.0170
4	0.218	0.1400