



## Standard Rectifier

$$V_{RRM} = 1600V$$

$$I_{FAV} = 80A$$

$$V_F = 1,22V$$

## Single Diode

Part number

**DMA80IM1600HB**

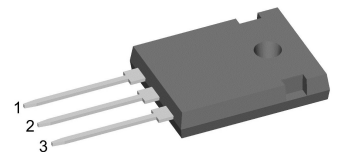

Backside: cathode

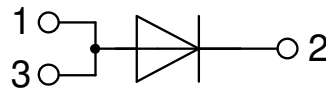

### Features / Advantages:

- Planar passivated chips
- Very low leakage current
- Very low forward voltage drop
- Improved thermal behaviour
- High commutation robustness
- High surge capability

### Applications:

- Diode for main rectification
- For single and three phase bridge configurations

### Package: TO-247

- Industry standard outline
- RoHS compliant
- Epoxy meets UL 94V-0

### Disclaimer Notice

Information furnished is believed to be accurate and reliable. However, users should independently evaluate the suitability of and test each product selected for their own applications. Littelfuse products are not designed for, and may not be used in, all applications. Read complete Disclaimer Notice at [www.littelfuse.com/disclaimer-electronics](http://www.littelfuse.com/disclaimer-electronics).

Rectifier				Ratings			
Symbol	Definition	Conditions	min.	typ.	max.	Unit	
$V_{RSM}$	max. non-repetitive reverse blocking voltage	$T_{VJ} = 25^{\circ}C$			1700	V	
$V_{RRM}$	max. repetitive reverse blocking voltage	$T_{VJ} = 25^{\circ}C$			1600	V	
$I_R$	reverse current	$V_R = 1600\text{ V}$	$T_{VJ} = 25^{\circ}C$		40	$\mu A$	
		$V_R = 1600\text{ V}$	$T_{VJ} = 150^{\circ}C$		1,5	mA	
$V_F$	forward voltage drop	$I_F = 80\text{ A}$	$T_{VJ} = 25^{\circ}C$		1,27	V	
		$I_F = 160\text{ A}$			1,55	V	
		$I_F = 80\text{ A}$	$T_{VJ} = 150^{\circ}C$		1,22	V	
		$I_F = 160\text{ A}$			1,59	V	
$I_{FAV}$	average forward current	$T_C = 125^{\circ}C$ 180° sine	$T_{VJ} = 175^{\circ}C$		80	A	
$V_{FO}$	threshold voltage	} for power loss calculation only	$T_{VJ} = 175^{\circ}C$		0,82	V	
$r_F$	slope resistance				4,8	m $\Omega$	
$R_{thJC}$	thermal resistance junction to case				0,35	K/W	
$R_{thCH}$	thermal resistance case to heatsink			0,25		K/W	
$P_{tot}$	total power dissipation		$T_C = 25^{\circ}C$		430	W	
$I_{FSM}$	max. forward surge current	$t = 10\text{ ms; (50 Hz), sine}$	$T_{VJ} = 45^{\circ}C$		1,30	kA	
		$t = 8,3\text{ ms; (60 Hz), sine}$	$V_R = 0\text{ V}$		1,41	kA	
		$t = 10\text{ ms; (50 Hz), sine}$	$T_{VJ} = 150^{\circ}C$		1,11	kA	
		$t = 8,3\text{ ms; (60 Hz), sine}$	$V_R = 0\text{ V}$		1,20	kA	
$I^2t$	value for fusing	$t = 10\text{ ms; (50 Hz), sine}$	$T_{VJ} = 45^{\circ}C$		8,45	kA <sup>2</sup> s	
		$t = 8,3\text{ ms; (60 Hz), sine}$	$V_R = 0\text{ V}$		8,21	kA <sup>2</sup> s	
		$t = 10\text{ ms; (50 Hz), sine}$	$T_{VJ} = 150^{\circ}C$		6,11	kA <sup>2</sup> s	
		$t = 8,3\text{ ms; (60 Hz), sine}$	$V_R = 0\text{ V}$		5,94	kA <sup>2</sup> s	
$C_J$	junction capacitance	$V_R = 400\text{ V; } f = 1\text{ MHz}$	$T_{VJ} = 25^{\circ}C$		43	pF	



Package TO-247			Ratings			
Symbol	Definition	Conditions	min.	typ.	max.	Unit
$I_{RMS}$	RMS current	per terminal			70	A
$T_{VJ}$	virtual junction temperature		-55		175	°C
$T_{op}$	operation temperature		-55		150	°C
$T_{stg}$	storage temperature		-55		150	°C
<b>Weight</b>				6		g
$M_D$	mounting torque		0,8		1,2	Nm
$F_C$	mounting force with clip		20		120	N

**Product Marking**

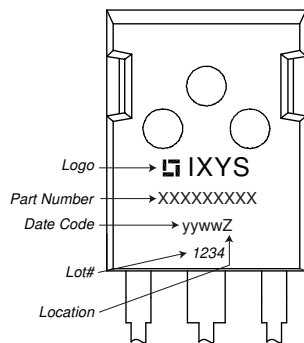

**Part description**

- D = Diode
- M = Standard Rectifier
- A = (up to 1800V)
- 80 = Current Rating [A]
- IM = Single Diode
- 1600 = Reverse Voltage [V]
- HB = TO-247AD (3)

Ordering	Ordering Number	Marking on Product	Delivery Mode	Quantity	Code No.
Standard	DMA80IM1600HB	DMA80IM1600HB	Tube	30	505616

**Equivalent Circuits for Simulation**

*\* on die level*

$T_{VJ} = 175^{\circ}C$

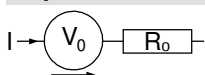

**Rectifier**

$V_{0\ max}$	threshold voltage	0,82	V
$R_{0\ max}$	slope resistance *	2,6	mΩ



**Outlines TO-247**



Sym.	Inches		Millimeter	
	min.	max.	min.	max.
A	0.185	0.209	4.70	5.30
A1	0.087	0.102	2.21	2.59
A2	0.059	0.098	1.50	2.49
D	0.819	0.845	20.79	21.45
E	0.610	0.640	15.48	16.24
E2	0.170	0.216	4.31	5.48
e	0.215 BSC		5.46 BSC	
L	0.780	0.800	19.80	20.30
L1	-	0.177	-	4.49
Ø P	0.140	0.144	3.55	3.65
Q	0.212		5.38	
S	0.242 BSC		6.14 BSC	
b	0.039	0.055	0.99	1.40
b2	0.065	0.094	1.65	2.39
b4	0.102	0.135	2.59	3.43
c	0.015	0.035	0.38	0.89
D1	0.515	-	13.07	-
D2	0.020	0.053	0.51	1.35
E1	0.530	-	13.45	-
Ø P1	-	0.29	-	7.39

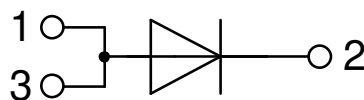



**Rectifier**

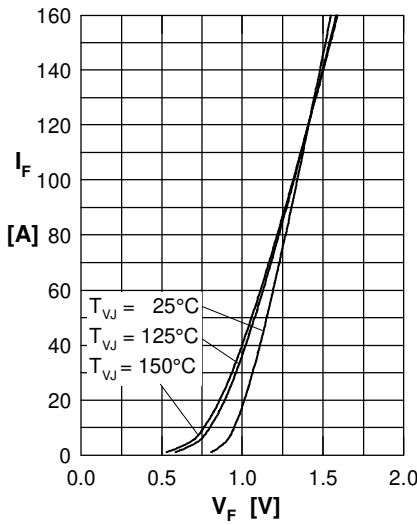

Fig. 1 Forward current versus voltage drop per diode

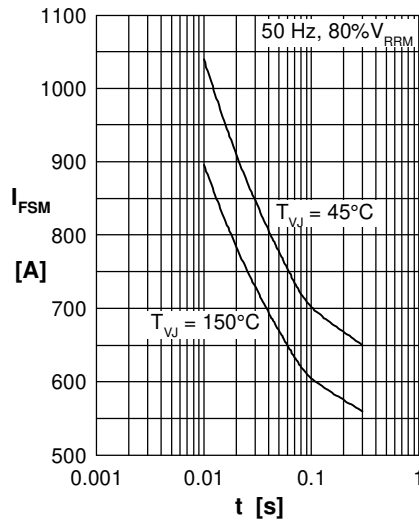

Fig. 2 Surge overload current versus time per diode

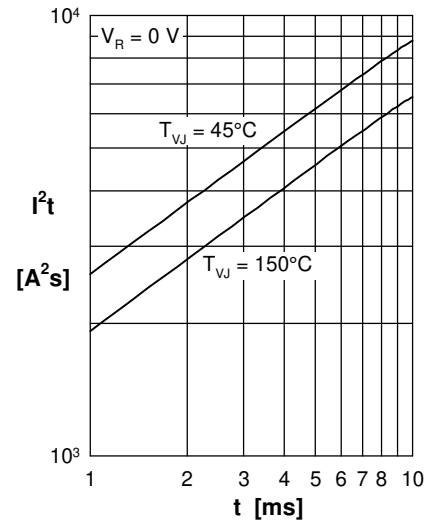

Fig. 3  $I^2t$  versus time per diode

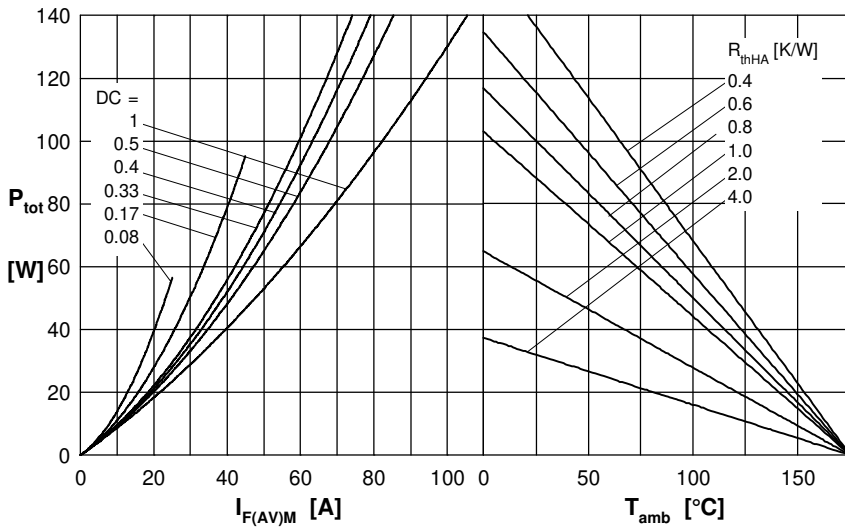

Fig. 4 Power dissipation versus direct output current and ambient temperature per diode

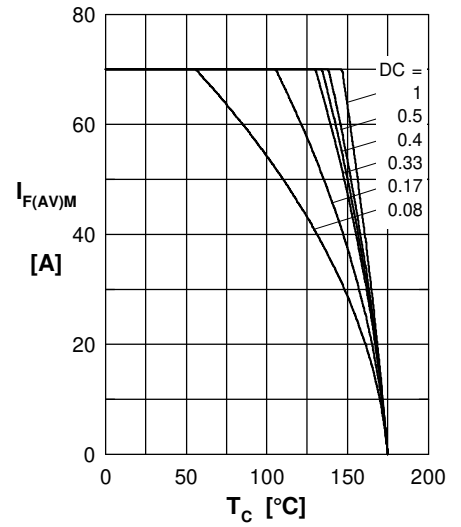

Fig. 5 Max. forward current versus case temperature per diode

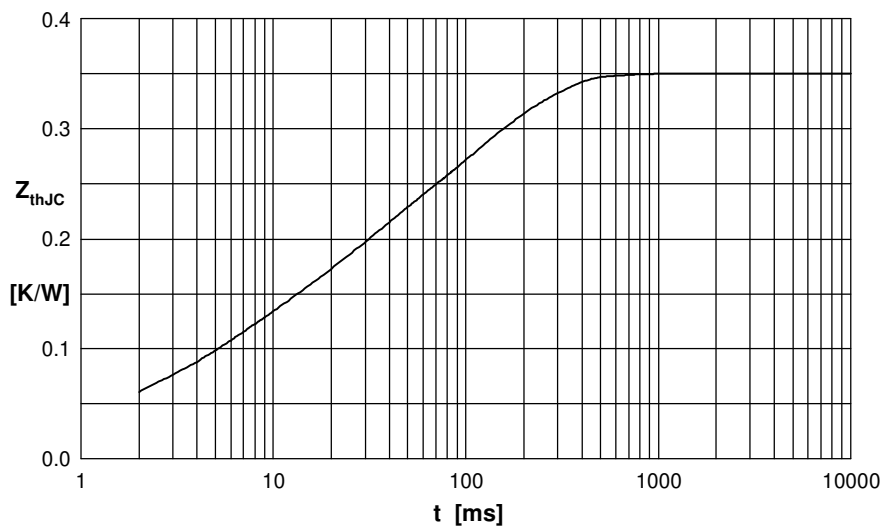

Fig. 6 Transient thermal impedance junction to case versus time per diode

Constants for  $Z_{thJC}$  calculation:

i	$R_{thi}$ (K/W)	$t_i$ (s)
1	0.023	0.0006
2	0.065	0.0038
3	0.094	0.0190
4	0.168	0.1300