

# Standard Rectifier

<b>3~ Rectifier</b>	
$V_{RRM}$	= 1800 V
$I_{DAV}$	= 90 A
$I_{FSM}$	= 350 A

ISOPLUS™  
 Surface Mount Power Device  
 3~ Rectifier Bridge

Part number

**DMA90U1800LB**

Marking on Product: DMA90U1800LB

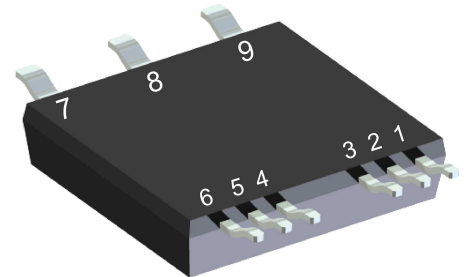

Backside: isolated

 E72873

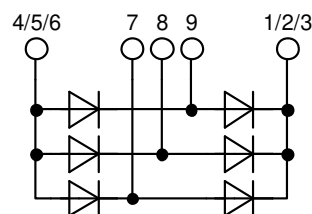

### Features / Advantages:

- Rectifier diode
- Isolated back surface
- Low coupling capacity between pins and heatsink
- Enlarged creepage towards heatsink
- Application friendly pinout
- Low inductive current path
- High reliability

### Applications:

- Line rectifying 50/60 Hz
- Drives
- SMPS
- UPS

### Package: SMPD

- Isolation Voltage: 3000 V~
- Industry convenient outline
- RoHS compliant
- Epoxy meets UL 94V-0
- Soldering pins for PCB mounting
- Backside: DCB ceramic
- Reduced weight
- Advanced power cycling

### Disclaimer Notice

Information furnished is believed to be accurate and reliable. However, users should independently evaluate the suitability of and test each product selected for their own applications. Littelfuse products are not designed for, and may not be used in, all applications. Read complete Disclaimer Notice at [www.littelfuse.com/disclaimer-electronics](http://www.littelfuse.com/disclaimer-electronics).



Rectifier				Ratings			
Symbol	Definition	Conditions		min.	typ.	max.	Unit
$V_{RSM}$	max. non-repetitive reverse blocking voltage					1900	V
$V_{RRM}$	max. repetitive reverse blocking voltage					1800	V
$I_R$	reverse current	$V_R = 1800$ V	$T_{VJ} = 25^\circ\text{C}$			40	$\mu\text{A}$
		$V_R = 1800$ V	$T_{VJ} = 150^\circ\text{C}$			1.5	mA
$V_F$	forward voltage drop	$I_F = 30$ A	$T_{VJ} = 25^\circ\text{C}$			1.26	V
						1.79	V
		$I_F = 90$ A	$T_{VJ} = 150^\circ\text{C}$			1.20	V
						1.93	V
$I_{DAV}$	bridge output current	$T_C = 110^\circ\text{C}$ rectangular	$d = \frac{1}{3}$	$T_{VJ} = 175^\circ\text{C}$		90	A
$V_{F0}$	threshold voltage	} for power loss calculation only		$T_{VJ} = 175^\circ\text{C}$		0.81	V
$r_F$	slope resistance					12.7	m $\Omega$
$R_{thJC}$	thermal resistance junction to case					1.1	K/W
$R_{thCH}$	thermal resistance case to heatsink				0.4		K/W
$P_{tot}$	total power dissipation			$T_C = 25^\circ\text{C}$		135	W
$I_{FSM}$	max. forward surge current	t = 10 ms; (50 Hz), sine	$T_{VJ} = 45^\circ\text{C}$	$V_R = 0$ V		350	A
						380	A
		t = 8,3 ms; (60 Hz), sine	$T_{VJ} = 150^\circ\text{C}$	$V_R = 0$ V		300	A
						320	A
$I^2t$	value for fusing	t = 10 ms; (50 Hz), sine	$T_{VJ} = 45^\circ\text{C}$	$V_R = 0$ V		615	A <sup>2</sup> s
						600	A <sup>2</sup> s
		t = 8,3 ms; (60 Hz), sine	$T_{VJ} = 150^\circ\text{C}$	$V_R = 0$ V		450	A <sup>2</sup> s
						425	A <sup>2</sup> s
$C_J$	junction capacitance	$V_R = 400$ V; f = 1 MHz		$T_{VJ} = 25^\circ\text{C}$		11	pF



Package SMPD		Ratings				
Symbol	Definition	Conditions	min.	typ.	max.	Unit
$I_{RMS}$	RMS current	per terminal			100	A
$T_{VJ}$	virtual junction temperature		-55		175	°C
$T_{op}$	operation temperature		-55		150	°C
$T_{stg}$	storage temperature		-55		150	°C
<b>Weight</b>				8.5		g
$F_C$	mounting force with clip		40		130	N
$d_{Spp/ App}$	creepage distance on surface / striking distance through air	terminal to terminal	1.6			mm
$d_{Spb/ Apb}$		terminal to backside	4.0			mm
$V_{ISOL}$	isolation voltage	t = 1 second	3000			V
		t = 1 minute	2500			V

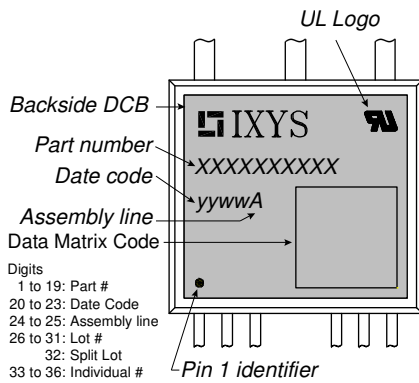

**Part description**

- D = Diode
- M = Standard Rectifier
- A = (up to 1800V)
- 90 = Current Rating [A]
- U = 3- Rectifier Bridge
- 1800 = Reverse Voltage [V]
- LB = SMPD-B

Ordering	Ordering Number	Marking on Product	Delivery Mode	Quantity	Code No.
Standard	DMA90U1800LB-TUB	DMA90U1800LB	Tube	20	517130
Alternative	DMA90U1800LB-TRR	DMA90U1800LB	Tape & Reel	200	524497

**Equivalent Circuits for Simulation**

\* on die level

$T_{VJ} = 175\text{ °C}$

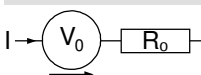

**Rectifier**

$V_{0\ max}$	threshold voltage	0.81	V
$R_{0\ max}$	slope resistance *	10.1	mΩ



**Outlines SMPD**

**A ( 8 : 1 )**

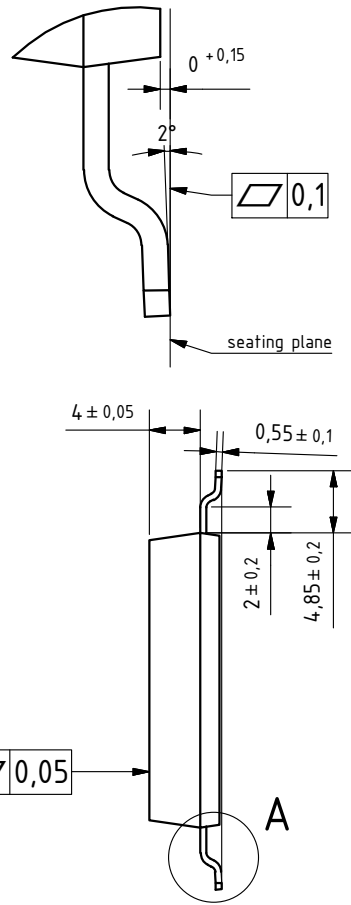
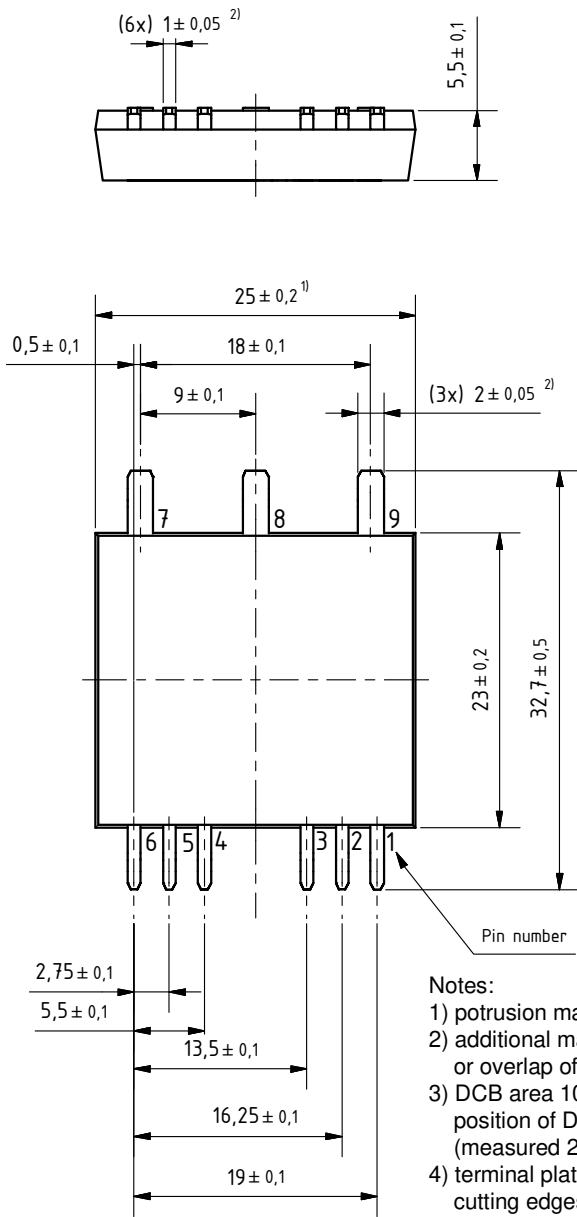

**Notes:**

- 1) protrusion may add 0.2 mm max. on each side
- 2) additional max. 0.05 mm per side by punching misalignment or overlap of dam bar or bending compression
- 3) DCB area 10 to 50  $\mu\text{m}$  convex; position of DCB area in relation to plastic rim:  $\pm 25 \mu\text{m}$  (measured 2 mm from Cu rim)
- 4) terminal plating: 0.2 - 1  $\mu\text{m}$  Ni + 10 - 25  $\mu\text{m}$  Sn (gal v.) cutting edges may be partially free of plating

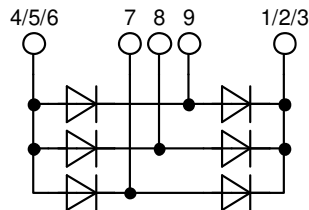



**Rectifier**

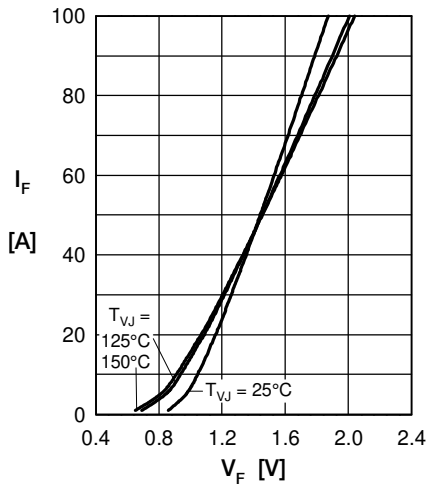

Fig. 1 Forward current vs. voltage drop per diode

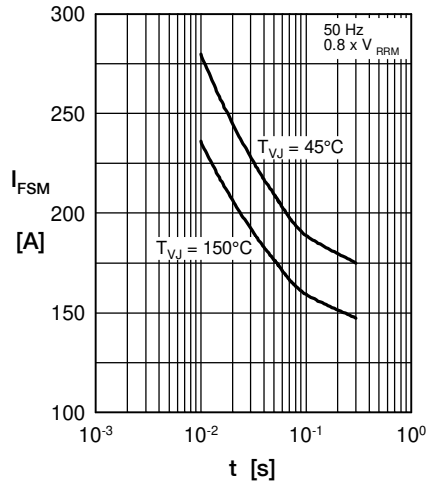

Fig. 2 Surge overload current vs. time per diode

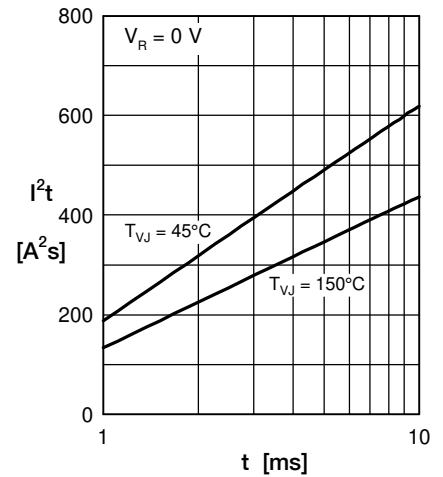

Fig. 3  $I^2t$  vs. time per diode

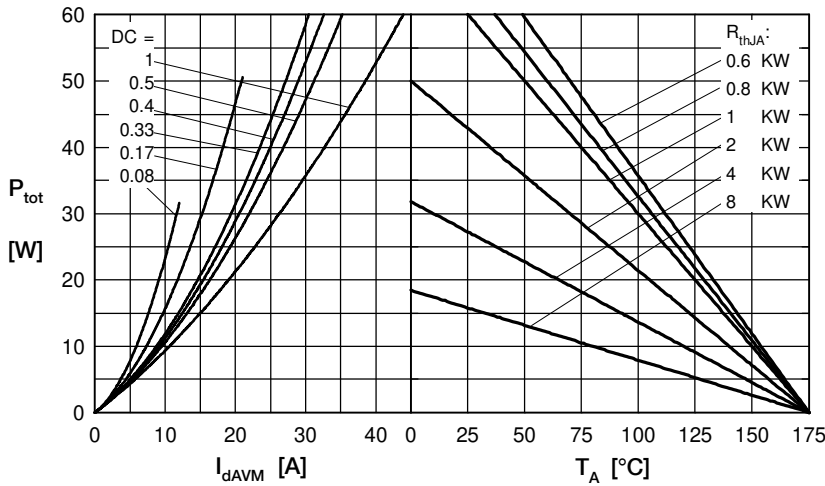

Fig. 4 Power dissipation vs. forward current and ambient temperature per diode

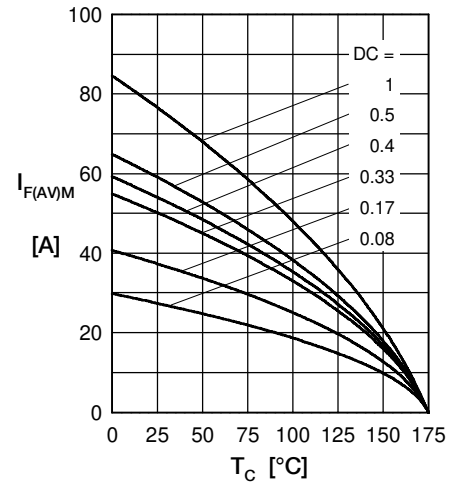

Fig. 5 Max. forward current vs. case temperature per diode

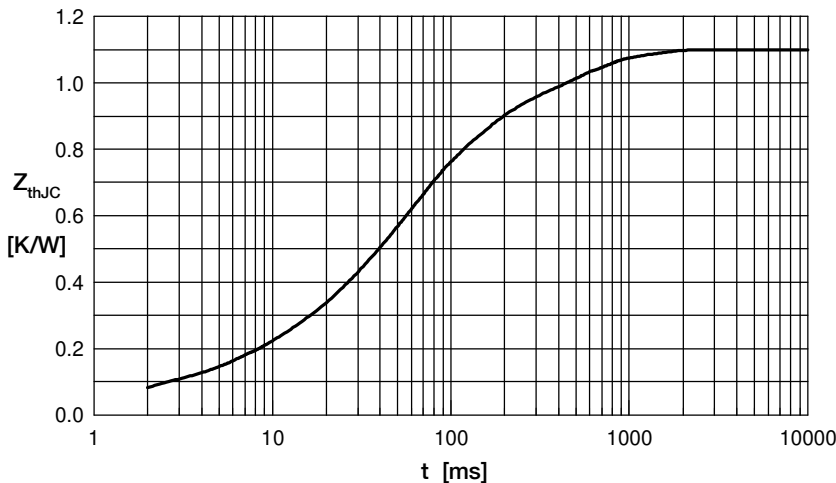

Fig. 6 Transient thermal impedance junction to case vs. time per diode

Constants for  $Z_{thJC}$  calculation:

i	$R_{th}$ (K/W)	$t_i$ (s)
1	0.030	0.0003
2	0.072	0.0045
3	0.092	0.0530
4	0.606	0.0520
5	0.300	0.4000