



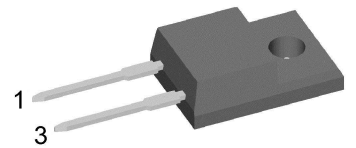
# HiPerFRED<sup>2</sup>

$V_{RRM}$	=	400 V
$I_{FAV}$	=	15 A
$t_{rr}$	=	45 ns

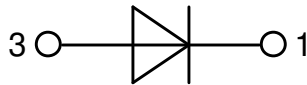
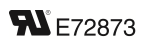
High Performance Fast Recovery Diode  
Low Loss and Soft Recovery  
Single Diode

Part number

**DPG15I400PM**



Backside: isolated



**Features / Advantages:**

- Planar passivated chips
- Very low leakage current
- Very short recovery time
- Improved thermal behaviour
- Very low I<sub>rm</sub>-values
- Very soft recovery behaviour
- Avalanche voltage rated for reliable operation
- Soft reverse recovery for low EMI/RFI
- Low I<sub>rm</sub> reduces:
  - Power dissipation within the diode
  - Turn-on loss in the commutating switch

**Applications:**

- Antiparallel diode for high frequency switching devices
- Antisaturation diode
- Snubber diode
- Free wheeling diode
- Rectifiers in switch mode power supplies (SMPS)
- Uninterruptible power supplies (UPS)

**Package: TO-220FP**

- Isolation Voltage: 2500 V~
- Industry standard outline
- RoHS compliant
- Epoxy meets UL 94V-0
- Soldering pins for PCB mounting
- Base plate: Plastic overmolded tab
- Reduced weight

**Disclaimer Notice**

Information furnished is believed to be accurate and reliable. However, users should independently evaluate the suitability of and test each product selected for their own applications. Littelfuse products are not designed for, and may not be used in, all applications. Read complete Disclaimer Notice at [www.littelfuse.com/disclaimer-electronics](http://www.littelfuse.com/disclaimer-electronics).

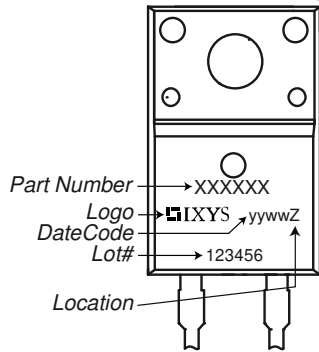


Fast Diode				Ratings			
Symbol	Definition	Conditions	min.	typ.	max.	Unit	
$V_{RSM}$	max. non-repetitive reverse blocking voltage	$T_{VJ} = 25^{\circ}C$			400	V	
$V_{RRM}$	max. repetitive reverse blocking voltage	$T_{VJ} = 25^{\circ}C$			400	V	
$I_R$	reverse current, drain current	$V_R = 400 V$	$T_{VJ} = 25^{\circ}C$		1	$\mu A$	
		$V_R = 400 V$	$T_{VJ} = 150^{\circ}C$		0.18	mA	
$V_F$	forward voltage drop	$I_F = 15 A$	$T_{VJ} = 25^{\circ}C$		1.39	V	
		$I_F = 30 A$			1.63	V	
		$I_F = 15 A$	$T_{VJ} = 150^{\circ}C$		1.14	V	
		$I_F = 30 A$			1.40	V	
$I_{FAV}$	average forward current	$T_C = 90^{\circ}C$ rectangular $d = 0.5$	$T_{VJ} = 175^{\circ}C$		15	A	
$V_{FO}$	threshold voltage	} for power loss calculation only	$T_{VJ} = 175^{\circ}C$		0.84	V	
$r_F$	slope resistance				16.5	m $\Omega$	
$R_{thJC}$	thermal resistance junction to case				4.2	K/W	
$R_{thCH}$	thermal resistance case to heatsink			0.5		K/W	
$P_{tot}$	total power dissipation		$T_C = 25^{\circ}C$		35	W	
$I_{FSM}$	max. forward surge current	$t = 10 ms; (50 Hz), sine; V_R = 0 V$	$T_{VJ} = 45^{\circ}C$		190	A	
$C_J$	junction capacitance	$V_R = 200 V \quad f = 1 MHz$	$T_{VJ} = 25^{\circ}C$		16	pF	
$I_{RM}$	max. reverse recovery current	} $I_F = 15 A; V_R = 270 V$ $-di_F / dt = 200 A/\mu s$	$T_{VJ} = 25^{\circ}C$		4	A	
			$T_{VJ} = 125^{\circ}C$		5.5	A	
$t_{rr}$	reverse recovery time		$T_{VJ} = 25^{\circ}C$		45	ns	
			$T_{VJ} = 125^{\circ}C$		70	ns	



Package TO-220FP		Ratings				
Symbol	Definition	Conditions	min.	typ.	max.	Unit
$I_{RMS}$	RMS current	per terminal			35	A
$T_{VJ}$	virtual junction temperature		-55		175	°C
$T_{op}$	operation temperature		-55		150	°C
$T_{stg}$	storage temperature		-55		150	°C
<b>Weight</b>				2		g
$M_D$	mounting torque		0.4		0.6	Nm
$F_C$	mounting force with clip		20		60	N
$d_{Spp/App}$	creepage distance on surface   striking distance through air	terminal to terminal	3.2	2.7		mm
$d_{Spb/Apb}$		terminal to backside	2.5	2.5		mm
$V_{ISOL}$	isolation voltage	t = 1 second	2500			V
		t = 1 minute	2100			V

**Product Marking**



**Part description**

- D = Diode
- P = HiPerFRED
- G = extreme fast
- 15 = Current Rating [A]
- I = Single Diode
- 400 = Reverse Voltage [V]
- PM = TO-220ACFP (2)

Ordering	Ordering Number	Marking on Product	Delivery Mode	Quantity	Code No.
Standard	DPG15I400PM	DPG15I400PM	Tube	50	503814

**Equivalent Circuits for Simulation**

\* on die level

$T_{VJ} = 175^{\circ}C$

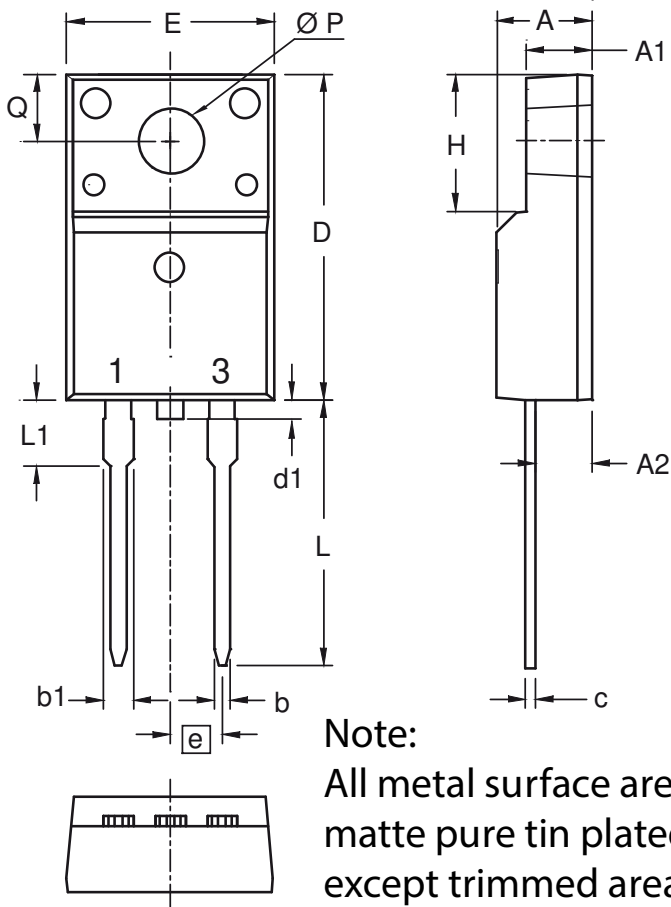


**Fast Diode**

$V_{0\ max}$	threshold voltage	0.84	V
$R_{0\ max}$	slope resistance *	13.3	mΩ



**Outlines TO-220FP**



Dim.	Millimeters		Inches	
	min	max	min	max
A	4.50	4.90	0.177	0.193
A1	2.34	2.74	0.092	0.108
A2	2.56	2.96	0.101	0.117
b	0.70	0.90	0.028	0.035
b1	1.27	1.47	0.050	0.058
c	0.45	0.60	0.018	0.024
D	15.67	16.07	0.617	0.633
d1	0	1.10	0	0.043
E	9.96	10.36	0.392	0.408
e	2.54 BSC		0.100 BSC	
H	6.48	6.88	0.255	0.271
L	12.68	13.28	0.499	0.523
L1	3.03	3.43	0.119	0.135
ØP	3.08	3.28	0.121	0.129
Q	3.20	3.40	0.126	0.134



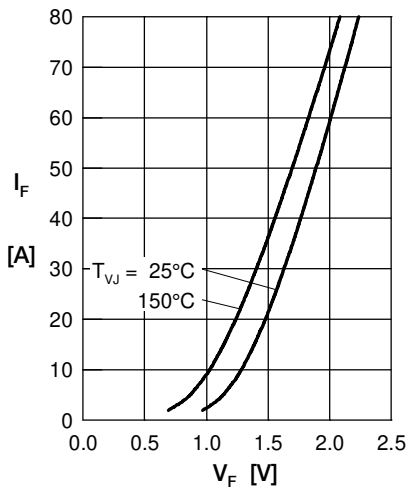
**Fast Diode**


Fig. 1 Forward current  $I_F$  versus  $V_F$

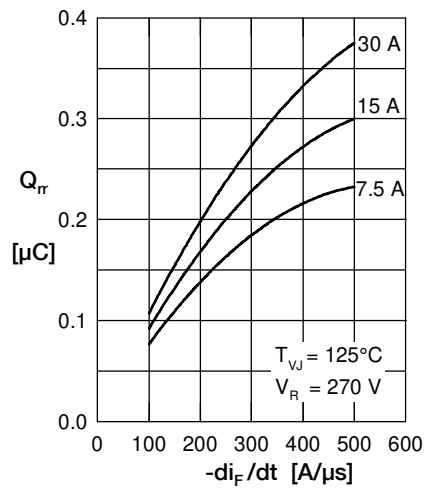


Fig. 2 Typ. reverse recov. charge  $Q_{rr}$  versus  $-di_F/dt$

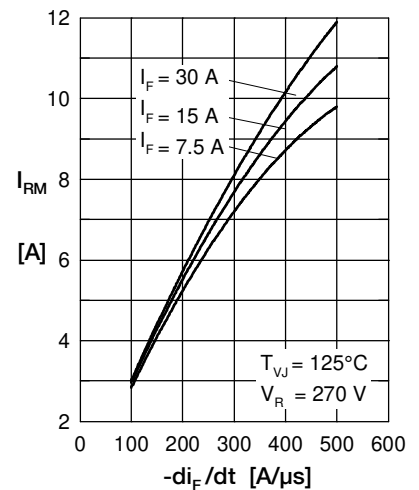


Fig. 3 Typ. peak reverse current  $I_{RM}$  versus  $-di_F/dt$

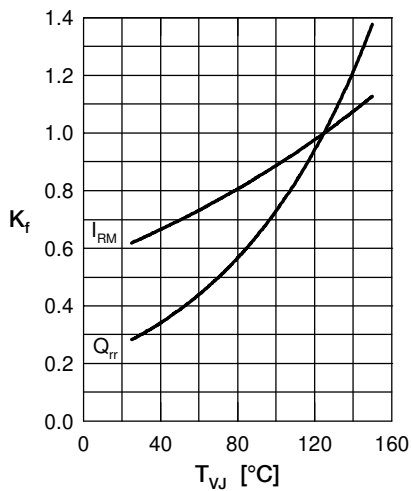


Fig. 4 Dynamic parameters  $Q_{rr}$ ,  $I_{RM}$  versus  $T_{VJ}$

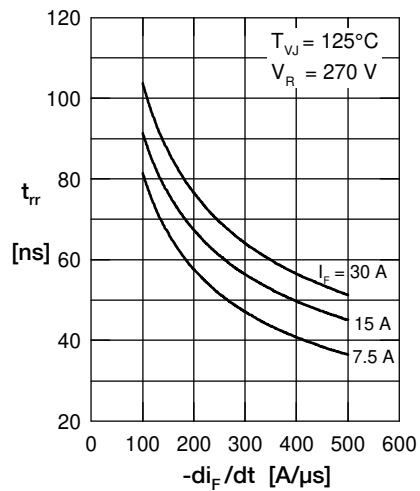


Fig. 5 Typ. recovery time  $t_{rr}$  versus  $-di_F/dt$

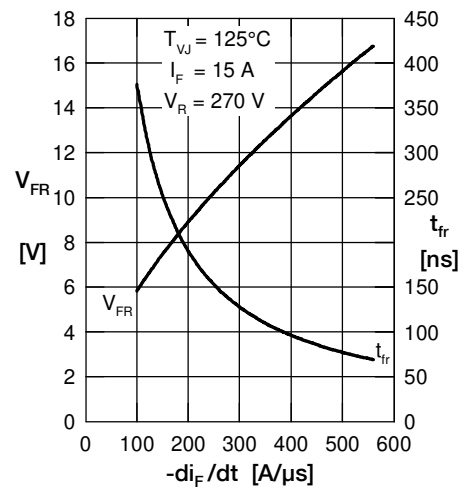


Fig. 6 Typ. peak forward voltage  $V_{FR}$  and  $t_{fr}$  versus  $di_F/dt$

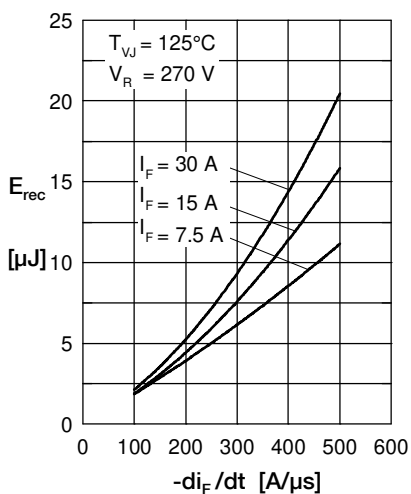


Fig. 7 Typ. recovery energy  $E_{rec}$  versus  $-di_F/dt$

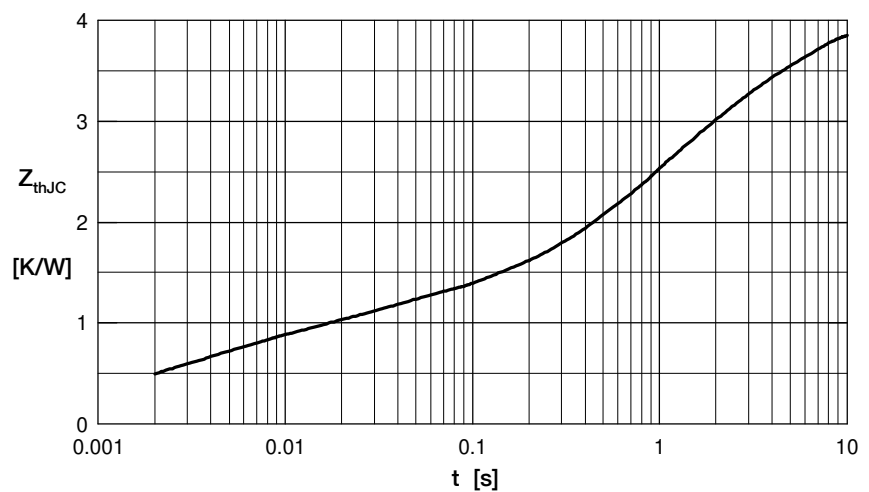


Fig. 8 Transient thermal resistance junction to case