

HiPerFRED²

$$V_{RRM} = 400 \text{ V}$$

$$I_{FAV} = 2 \times 15 \text{ A}$$

$$t_{rr} = 45 \text{ ns}$$

High Performance Fast Recovery Diode
 Low Loss and Soft Recovery
 Common Cathode

Part number

DPG30C400HB

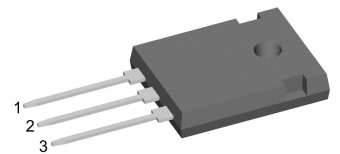

Backside: cathode

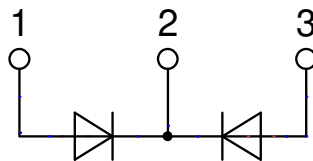

Features / Advantages:

- Planar passivated chips
- Very low leakage current
- Very short recovery time
- Improved thermal behaviour
- Very low I_{rm} -values
- Very soft recovery behaviour
- Avalanche voltage rated for reliable operation
- Soft reverse recovery for low EMI/RFI
- Low I_{rm} reduces:
 - Power dissipation within the diode
 - Turn-on loss in the commutating switch

Applications:

- Antiparallel diode for high frequency switching devices
- Antisaturation diode
- Snubber diode
- Free wheeling diode
- Rectifiers in switch mode power supplies (SMPS)
- Uninterruptible power supplies (UPS)

Package: TO-247

- Industry standard outline
- RoHS compliant
- Epoxy meets UL 94V-0

Disclaimer Notice

Information furnished is believed to be accurate and reliable. However, users should independently evaluate the suitability of and test each product selected for their own applications. Littelfuse products are not designed for, and may not be used in, all applications. Read complete Disclaimer Notice at www.littelfuse.com/disclaimer-electronics.



Fast Diode				Ratings			
Symbol	Definition	Conditions		min.	typ.	max.	Unit
V_{RSM}	max. non-repetitive reverse blocking voltage					400	V
V_{RRM}	max. repetitive reverse blocking voltage					400	V
I_R	reverse current, drain current	$V_R = 400\text{ V}$		$T_{VJ} = 25^\circ\text{C}$		1	μA
		$V_R = 400\text{ V}$		$T_{VJ} = 150^\circ\text{C}$		0.18	mA
V_F	forward voltage drop	$I_F = 15\text{ A}$		$T_{VJ} = 25^\circ\text{C}$		1.38	V
		$I_F = 30\text{ A}$				1.61	V
		$I_F = 15\text{ A}$		$T_{VJ} = 150^\circ\text{C}$		1.13	V
		$I_F = 30\text{ A}$				1.39	V
I_{FAV}	average forward current	$T_C = 140^\circ\text{C}$		$T_{VJ} = 175^\circ\text{C}$		15	A
		rectangular	$d = 0.5$				
V_{FO}	threshold voltage			$T_{VJ} = 175^\circ\text{C}$		0.84	V
r_F	slope resistance	} for power loss calculation only				15.9	m Ω
R_{thJC}	thermal resistance junction to case					1.7	K/W
R_{thCH}	thermal resistance case to heatsink				0.3		K/W
P_{tot}	total power dissipation			$T_C = 25^\circ\text{C}$		90	W
I_{FSM}	max. forward surge current	$t = 10\text{ ms}; (50\text{ Hz}), \text{ sine}; V_R = 0\text{ V}$		$T_{VJ} = 45^\circ\text{C}$		190	A
C_J	junction capacitance	$V_R = 200\text{ V}$ $f = 1\text{ MHz}$		$T_{VJ} = 25^\circ\text{C}$		16	pF
I_{RM}	max. reverse recovery current			$T_{VJ} = 25^\circ\text{C}$		4	A
		} $I_F = 15\text{ A}; V_R = 270\text{ V}$		$T_{VJ} = 125^\circ\text{C}$		5.5	A
t_{rr}	reverse recovery time	} $-di_F/dt = 200\text{ A}/\mu\text{s}$		$T_{VJ} = 25^\circ\text{C}$		45	ns
				$T_{VJ} = 125^\circ\text{C}$		70	ns



Package TO-247			Ratings			
Symbol	Definition	Conditions	min.	typ.	max.	Unit
I_{RMS}	RMS current	per terminal ¹⁾			35	A
T_{VJ}	virtual junction temperature		-55		175	°C
T_{op}	operation temperature		-55		150	°C
T_{stg}	storage temperature		-55		150	°C
Weight				6		g
M_D	mounting torque		0.8		1.2	Nm
F_C	mounting force with clip		20		120	N

Product Marking

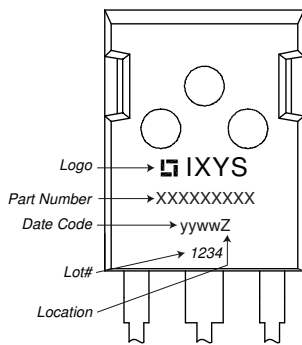

Part description

- D = Diode
- P = HiPerFRED
- G = extreme fast
- 30 = Current Rating [A]
- C = Common Cathode
- 400 = Reverse Voltage [V]
- HB = TO-247AD (3)

Ordering	Ordering Number	Marking on Product	Delivery Mode	Quantity	Code No.
Standard	DPG30C400HB	DPG30C400HB	Tube	30	505790

Similar Part	Package	Voltage class
DPG30C400PB	TO-220AB (3)	400

Equivalent Circuits for Simulation

** on die level*

$T_{VJ} = 175^{\circ}C$

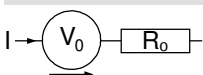

Fast Diode

$V_{0\ max}$	threshold voltage	0.84	V
$R_{0\ max}$	slope resistance *	13.3	mΩ



Outlines TO-247

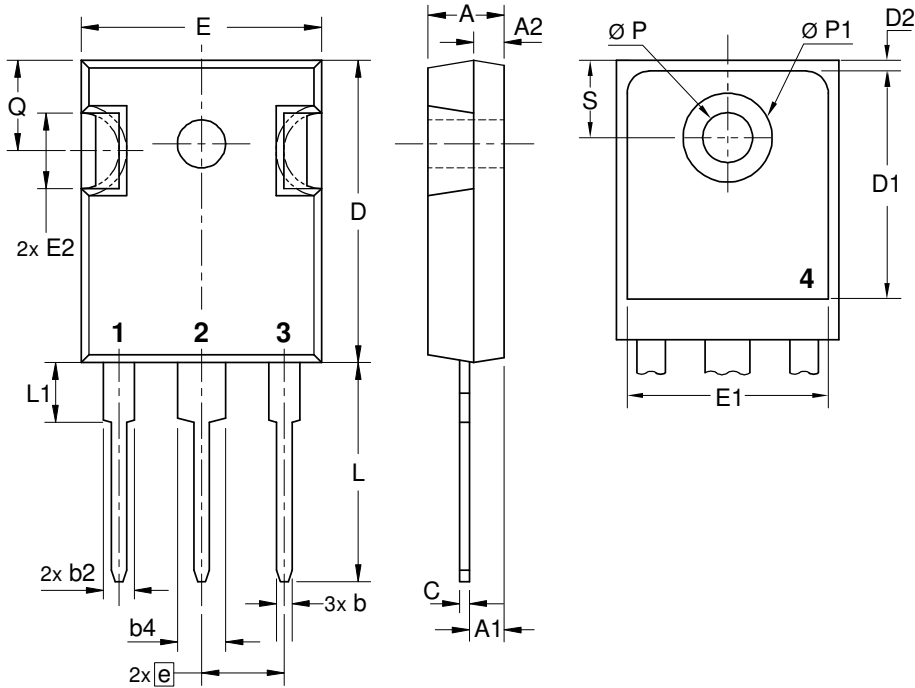

Sym.	Inches		Millimeter	
	min.	max.	min.	max.
A	0.185	0.209	4.70	5.30
A1	0.087	0.102	2.21	2.59
A2	0.059	0.098	1.50	2.49
D	0.819	0.845	20.79	21.45
E	0.610	0.640	15.48	16.24
E2	0.170	0.216	4.31	5.48
e	0.215 BSC		5.46 BSC	
L	0.780	0.800	19.80	20.30
L1	-	0.177	-	4.49
Ø P	0.140	0.144	3.55	3.65
Q	0.212		5.38	
S	0.242 BSC		6.14 BSC	
b	0.039	0.055	0.99	1.40
b2	0.065	0.094	1.65	2.39
b4	0.102	0.135	2.59	3.43
c	0.015	0.035	0.38	0.89
D1	0.515	-	13.07	-
D2	0.020	0.053	0.51	1.35
E1	0.530	-	13.45	-
Ø P1	-	0.29	-	7.39

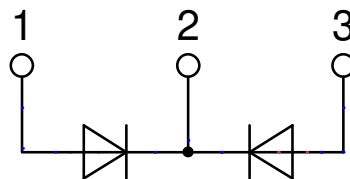



Fast Diode

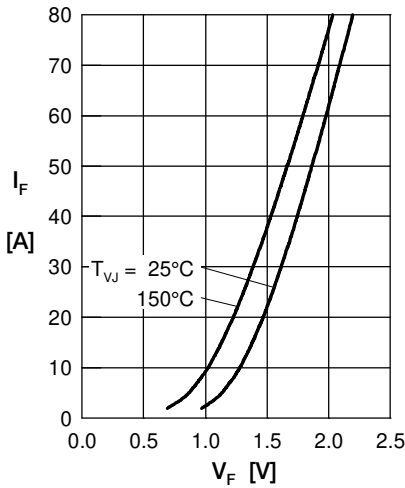

Fig. 1 Forward current I_F versus V_F

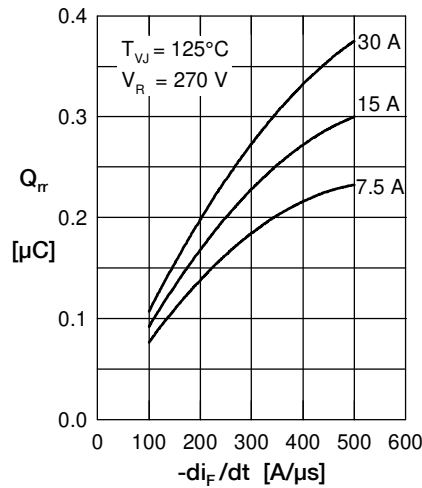

Fig. 2 Typ. reverse recov. charge Q_{rr} versus $-di_F/dt$

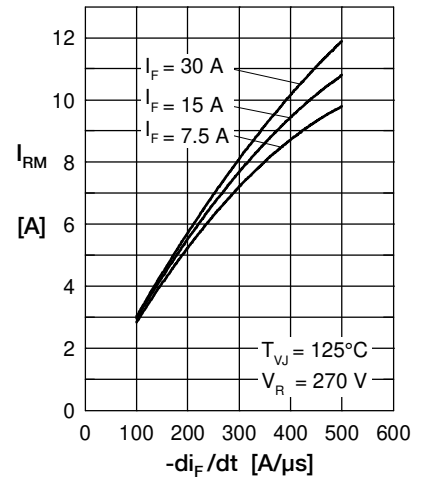

Fig. 3 Typ. peak reverse current I_{RM} versus $-di_F/dt$

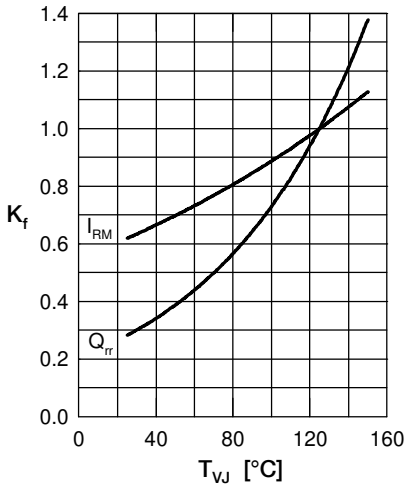

Fig. 4 Typ. dynamic parameters Q_{rr} , I_{RM} versus T_{VJ}

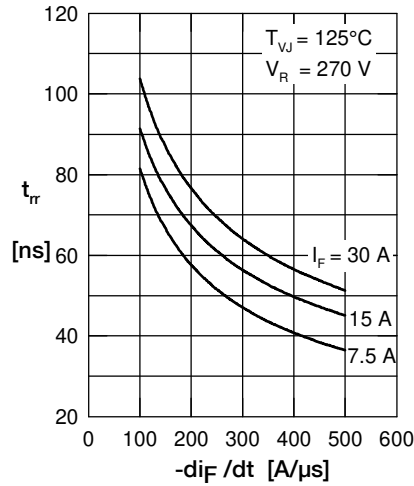

Fig. 5 Typ. recovery time t_{rr} versus $-di_F/dt$

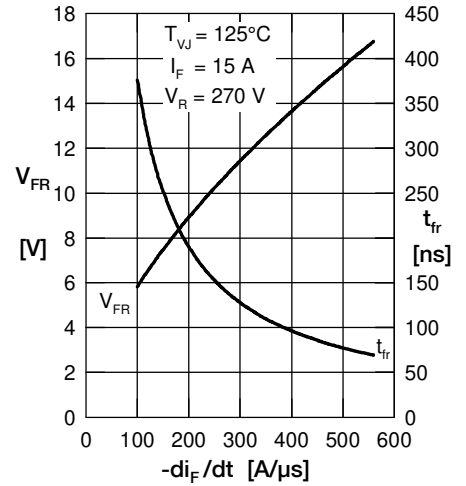

Fig. 6 Typ. peak forward voltage V_{FR} and t_{rr} versus di_F/dt

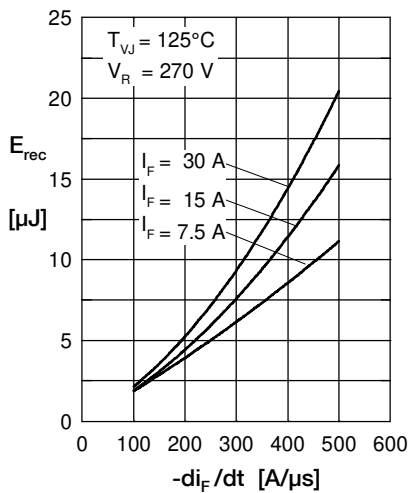

Fig. 7 Typ. recovery energy E_{rec} versus $-di_F/dt$

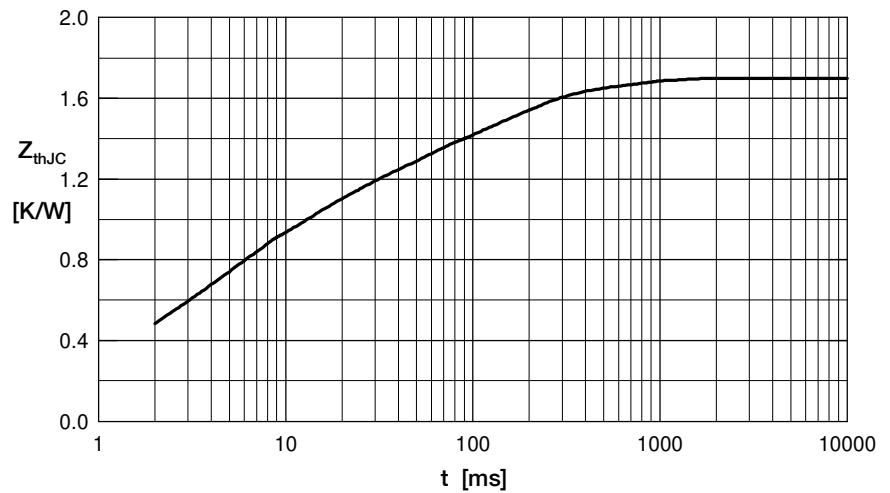

Fig. 8 Transient thermal resistance junction to case