

HiPerFRED

$V_{RRM} = 600\text{ V}$
 $I_{DAV} = 60\text{ A}$
 $t_{rr} = 40\text{ ns}$

High Performance Fast Recovery Diode
 Low Loss and Soft Recovery
 1~ Rectifier Bridge

Part number

DPG60B600LB

Marking on Product: DPG60B600LB

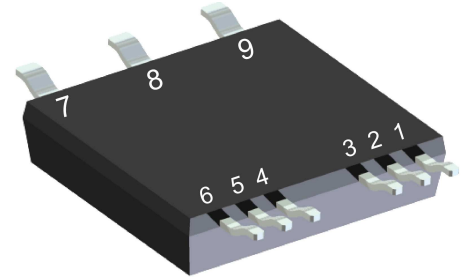

Backside: isolated

 E72873

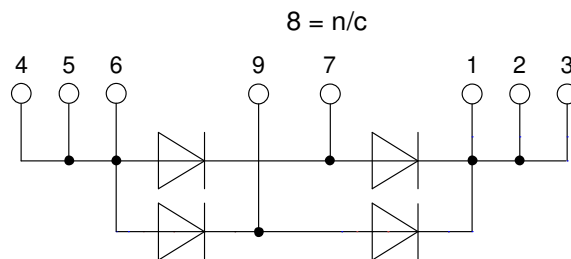

Features / Advantages:

- Planar passivated chips
- Very low leakage current
- Very short recovery time
- Improved thermal behaviour
- Very low I_{rm} -values
- Very soft recovery behaviour
- Avalanche voltage rated for reliable operation
- Soft reverse recovery for low EMI/RFI
- Low I_{rm} reduces:
 - Power dissipation within the diode
 - Turn-on loss in the commutating switch

Applications:

- Rectifiers in switch mode power supplies (SMPS)

Package: SMPD

- Isolation Voltage: 3000 V~
- Industry convenient outline
- RoHS compliant
- Epoxy meets UL 94V-0
- Soldering pins for PCB mounting
- Backside: DCB ceramic
- Reduced weight
- Advanced power cycling

Disclaimer Notice

Information furnished is believed to be accurate and reliable. However, users should independently evaluate the suitability of and test each product selected for their own applications. Littelfuse products are not designed for, and may not be used in, all applications. Read complete Disclaimer Notice at www.littelfuse.com/disclaimer-electronics.



Fast Diode				Ratings			
Symbol	Definition	Conditions	min.	typ.	max.	Unit	
V_{RSM}	max. non-repetitive reverse blocking voltage	$T_{VJ} = 25^{\circ}C$			600	V	
V_{RRM}	max. repetitive reverse blocking voltage	$T_{VJ} = 25^{\circ}C$			600	V	
I_R	reverse current, drain current	$V_R = 600 V$	$T_{VJ} = 25^{\circ}C$		250	μA	
		$V_R = 600 V$	$T_{VJ} = 150^{\circ}C$		2	mA	
V_F	forward voltage drop	$I_F = 30 A$	$T_{VJ} = 25^{\circ}C$		2.51	V	
		$I_F = 60 A$			3.19	V	
		$I_F = 30 A$	$T_{VJ} = 150^{\circ}C$		1.59	V	
		$I_F = 60 A$			2.21	V	
I_{DAV}	bridge output current	$T_C = 125^{\circ}C$ rectangular $d = 0.5$	$T_{VJ} = 175^{\circ}C$		60	A	
V_{FO}	threshold voltage	} for power loss calculation only	$T_{VJ} = 175^{\circ}C$		0.85	V	
r_F	slope resistance				17	m Ω	
R_{thJC}	thermal resistance junction to case				1.1	K/W	
R_{thCH}	thermal resistance case to heatsink			0.40		K/W	
P_{tot}	total power dissipation		$T_C = 25^{\circ}C$		135	W	
I_{FSM}	max. forward surge current	$t = 10 ms; (50 Hz), sine; V_R = 0 V$	$T_{VJ} = 45^{\circ}C$		250	A	
C_J	junction capacitance	$V_R = 300 V$ $f = 1 MHz$	$T_{VJ} = 25^{\circ}C$		30	pF	
I_{RM}	max. reverse recovery current	} $I_F = 30 A; V_R = 300 V$ $-di_F / dt = 400 A/\mu s$	$T_{VJ} = 25^{\circ}C$		5.5	A	
			$T_{VJ} = 125^{\circ}C$		12	A	
t_{rr}	reverse recovery time		$T_{VJ} = 25^{\circ}C$		40	ns	
			$T_{VJ} = 125^{\circ}C$		85	ns	



Package SMPD		Ratings				
Symbol	Definition	Conditions	min.	typ.	max.	Unit
I_{RMS}	RMS current	per terminal			50	A
T_{VJ}	virtual junction temperature		-55		175	°C
T_{op}	operation temperature		-55		150	°C
T_{stg}	storage temperature		-55		150	°C
Weight				8.5		g
F_C	mounting force with clip		40		130	N
$d_{Spp/ App}$	creepage distance on surface / striking distance through air	terminal to terminal	1.6			mm
$d_{Spb/ Apb}$		terminal to backside	4.0			mm
V_{ISOL}	isolation voltage	t = 1 second	3000			V
		t = 1 minute	2500			V

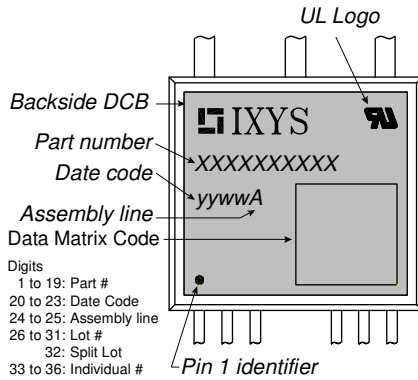

Part description

- D = Diode
- P = HiPerFRED
- G = extreme fast
- 60 = Current Rating [A]
- B = 1- Rectifier Bridge
- 600 = Reverse Voltage [V]
- LB = SMPD-B

Ordering	Ordering Number	Marking on Product	Delivery Mode	Quantity	Code No.
Standard	DPG60B600LB-TUB	DPG60B600LB	Tube	20	524759
Alternative	DPG60B600LB-TRR	DPG60B600LB	Tape & Reel	200	516148

Equivalent Circuits for Simulation

* on die level

$T_{VJ} = 175\text{ °C}$



$V_{0\ max}$	threshold voltage	0.85	V
$R_{0\ max}$	slope resistance *	17	mΩ



Outlines SMPD

A (8 : 1)

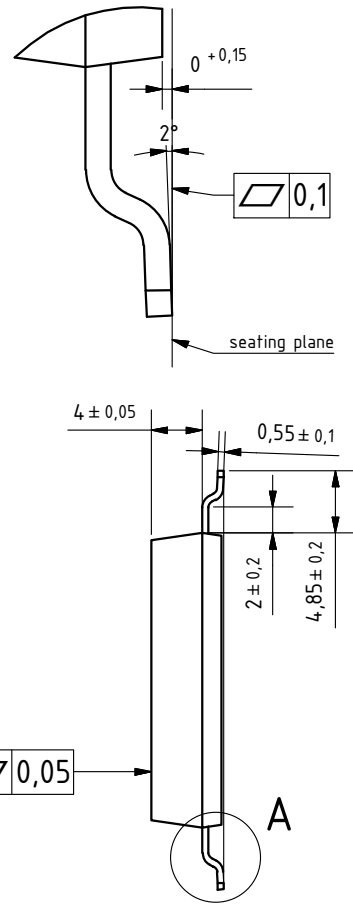
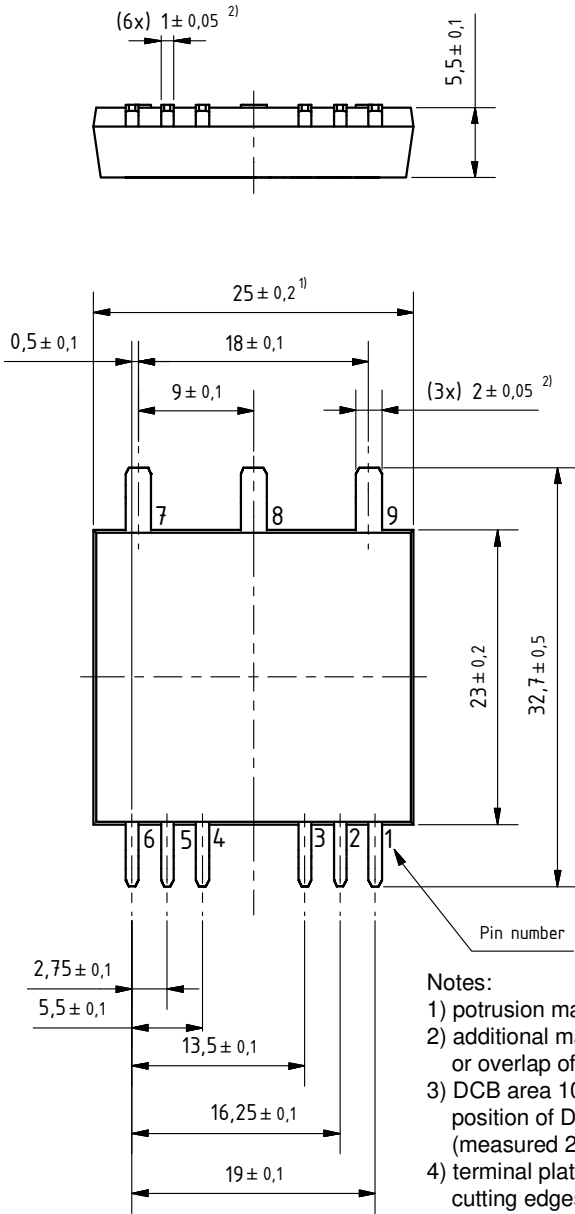

Notes:

- 1) protusion may add 0.2 mm max. on each side
- 2) additional max. 0.05 mm per side by punching misalignment or overlap of dam bar or bending compression
- 3) DCB area 10 to 50 μm convex; position of DCB area in relation to plastic rim: $\pm 25 \mu\text{m}$ (measured 2 mm from Cu rim)
- 4) terminal plating: 0.2 - 1 μm Ni + 10 - 25 μm Sn (gal v.) cutting edges may be partially free of plating

8 = n/c

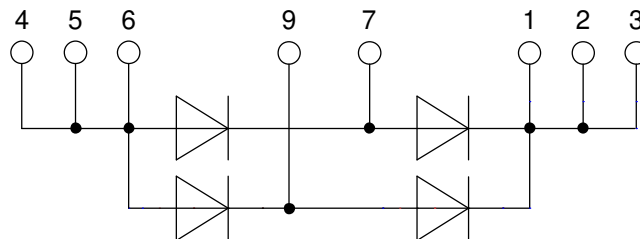

Fast Diode

 Fig. 1 Forward current I_F versus V_F

 Fig. 2 Typ. reverse recov. charge Q_r versus $-di_F/dt$

 Fig. 3 Typ. peak reverse current I_{RM} versus $-di_F/dt$

 Fig. 4 Dynamic parameters Q_r , I_{RM} versus T_{VJ}

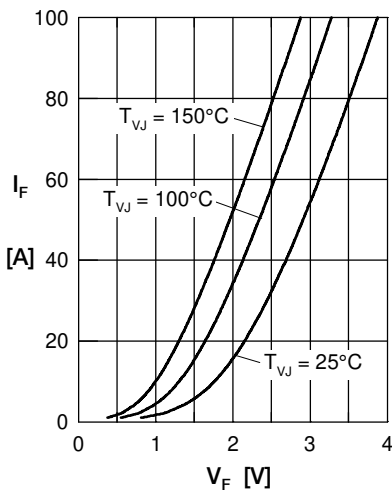
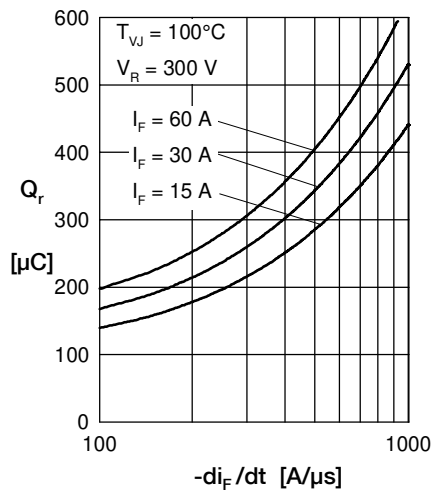
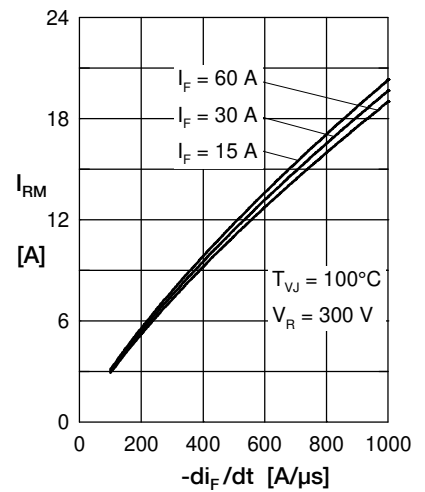
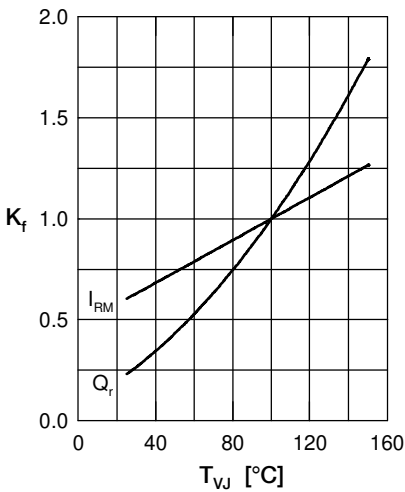
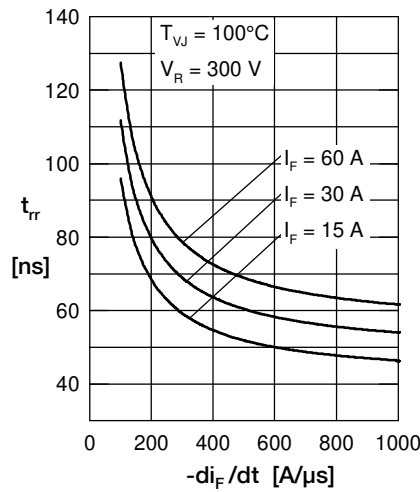
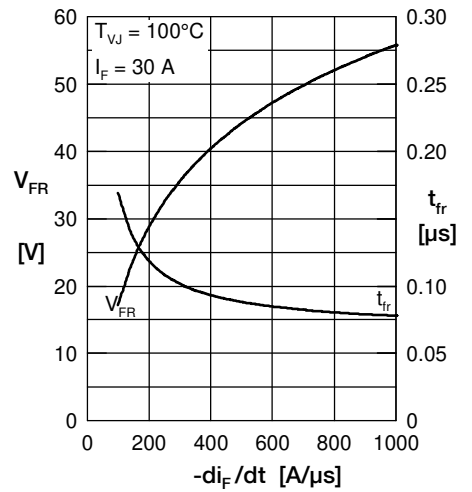
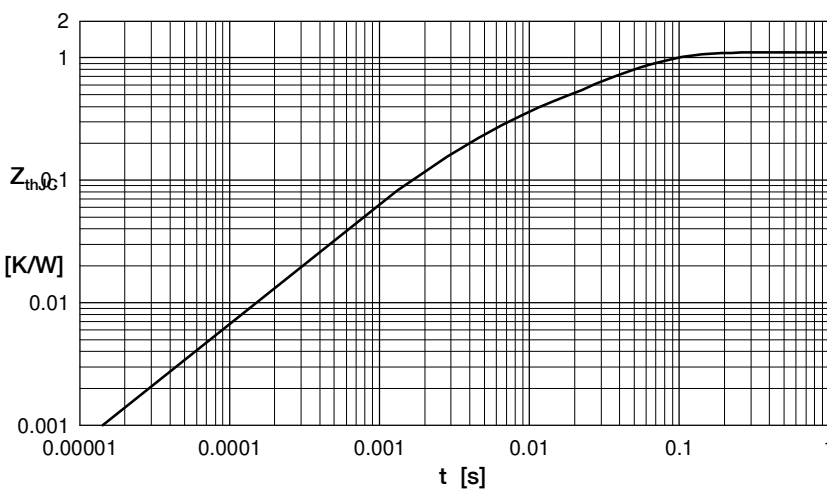
 Fig. 5 Typ. recovery time t_{tr} versus $-di_F/dt$

 Fig. 6 Typ. peak forward voltage V_{FR} and t_{tr} versus di_F/dt

Fig. 7 Transient thermal impedance junction to case

 Constants for Z_{thJC} calculation:

i	R_{thi} (K/W)	t_i (s)
1	0.465	0.0052
2	0.179	0.0003
3	0.256	0.0396