



Schottky Diode Gen 2

$V_{RRM} = 150\text{ V}$
 $I_{FAV} = 2 \times 75\text{ A}$
 $V_F = 0.74\text{ V}$

High Performance Schottky Diode
Low Loss and Soft Recovery
Parallel legs

Part number

DSA120X150LB

Marking on Product: *DSA120X150LB*

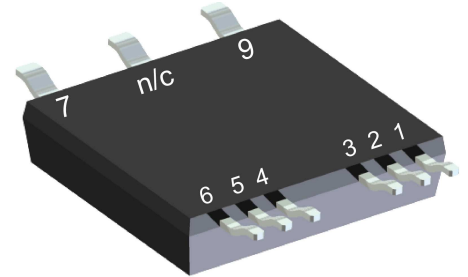

Backside: isolated

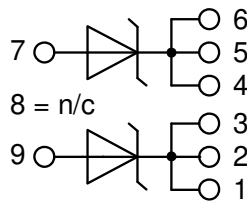
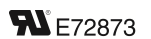

Features / Advantages:

- Very low V_f
- Extremely low switching losses
- Low I_{rm} values
- Improved thermal behaviour
- High reliability circuit operation
- Low voltage peaks for reduced protection circuits
- Low noise switching

Applications:

- Rectifiers in switch mode power supplies (SMPS)
- Free wheeling diode in low voltage converters

Package: SMPD

- Isolation Voltage: 3000 V~
- Industry convenient outline
- RoHS compliant
- Epoxy meets UL 94V-0
- Soldering pins for PCB mounting
- Backside: DCB ceramic
- Reduced weight
- Advanced power cycling

Disclaimer Notice

Information furnished is believed to be accurate and reliable. However, users should independently evaluate the suitability of and test each product selected for their own applications. Littelfuse products are not designed for, and may not be used in, all applications. Read complete Disclaimer Notice at www.littelfuse.com/disclaimer-electronics.



Schottky				Ratings			
Symbol	Definition	Conditions		min.	typ.	max.	Unit
V_{RSM}	max. non-repetitive reverse blocking voltage					150	V
V_{RRM}	max. repetitive reverse blocking voltage					150	V
I_R	reverse current, drain current	$V_R = 150\text{ V}$		$T_{VJ} = 25^\circ\text{C}$		1	mA
		$V_R = 150\text{ V}$		$T_{VJ} = 125^\circ\text{C}$		5	mA
V_F	forward voltage drop	$I_F = 60\text{ A}$		$T_{VJ} = 25^\circ\text{C}$		0.93	V
		$I_F = 120\text{ A}$				1.13	V
		$I_F = 60\text{ A}$		$T_{VJ} = 125^\circ\text{C}$		0.74	V
		$I_F = 120\text{ A}$				0.95	V
I_{FAV}	average forward current	$T_C = 135^\circ\text{C}$	rectangular	$T_{VJ} = 175^\circ\text{C}$		75	A
V_{FO}	threshold voltage	} for power loss calculation only		$T_{VJ} = 175^\circ\text{C}$		0.51	V
r_F	slope resistance					1.3	mΩ
R_{thJC}	thermal resistance junction to case					0.8	K/W
R_{thCH}	thermal resistance case to heatsink				0.40		K/W
P_{tot}	total power dissipation			$T_C = 25^\circ\text{C}$		185	W
I_{FSM}	max. forward surge current	$t = 10\text{ ms}; (50\text{ Hz}), \text{ sine}; V_R = 0\text{ V}$		$T_{VJ} = 45^\circ\text{C}$		700	A
C_J	junction capacitance	$V_R = 24\text{ V}$	$f = 1\text{ MHz}$	$T_{VJ} = 25^\circ\text{C}$		481	pF



Package SMPD		Ratings				
Symbol	Definition	Conditions	min.	typ.	max.	Unit
I_{RMS}	RMS current	per terminal			100	A
T_{VJ}	virtual junction temperature		-55		175	°C
T_{op}	operation temperature		-55		150	°C
T_{stg}	storage temperature		-55		150	°C
Weight				8.5		g
F_C	mounting force with clip		40		130	N
$d_{Spp/App}$	creepage distance on surface / striking distance through air	terminal to terminal	1.6			mm
$d_{Spb/Apb}$		terminal to backside	4.0			mm
V_{ISOL}	isolation voltage	t = 1 second	3000			V
		t = 1 minute	2500			V

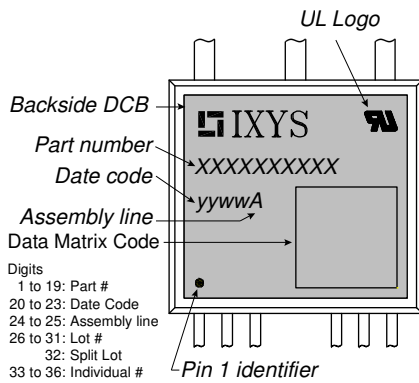

Part description

- D = Diode
- S = Schottky Diode
- A = low VF
- 120 = Current Rating [A]
- X = Parallel legs
- 150 = Reverse Voltage [V]
- LB = SMPD-B

Ordering	Ordering Number	Marking on Product	Delivery Mode	Quantity	Code No.
Standard	DSA120X150LB-TUB	DSA120X150LB	Tube	20	524766
Alternative	DSA120X150LB-TRR	DSA120X150LB	Tape & Reel	200	517173

Equivalent Circuits for Simulation

* on die level

$T_{VJ} = 175\text{ °C}$



Schottky

$V_{0\ max}$	threshold voltage	0.51	V
$R_{0\ max}$	slope resistance *	1.3	mΩ



Schottky

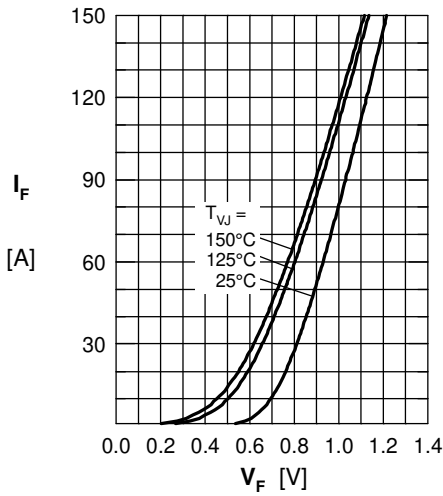

Fig. 1 Maximum forward voltage drop characteristics

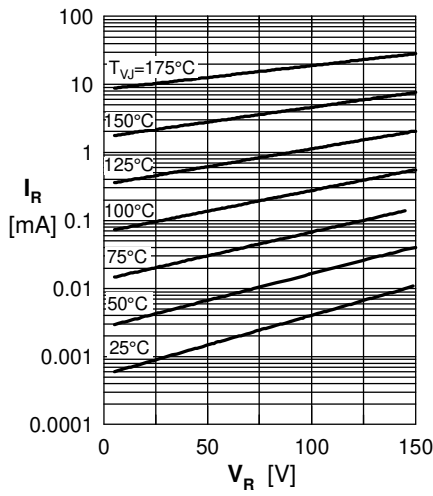

Fig. 2 Typ. reverse current I_R vs. reverse voltage V_R

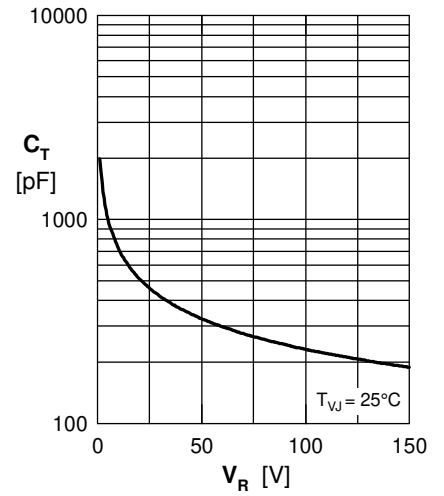

Fig. 3 Typ. junction capacitance C_T vs. reverse voltage V_R

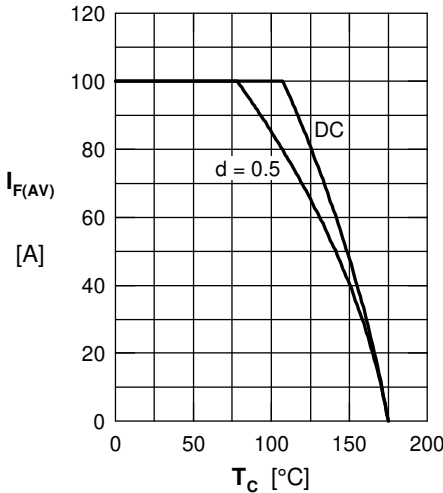

Fig. 4 Average forward current $I_{F(AV)}$ vs. case temperature T_C

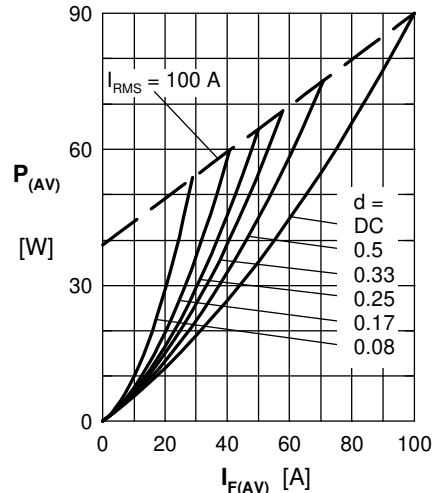

Fig. 5 Forward power loss @ $T_J = 175^\circ\text{C}$

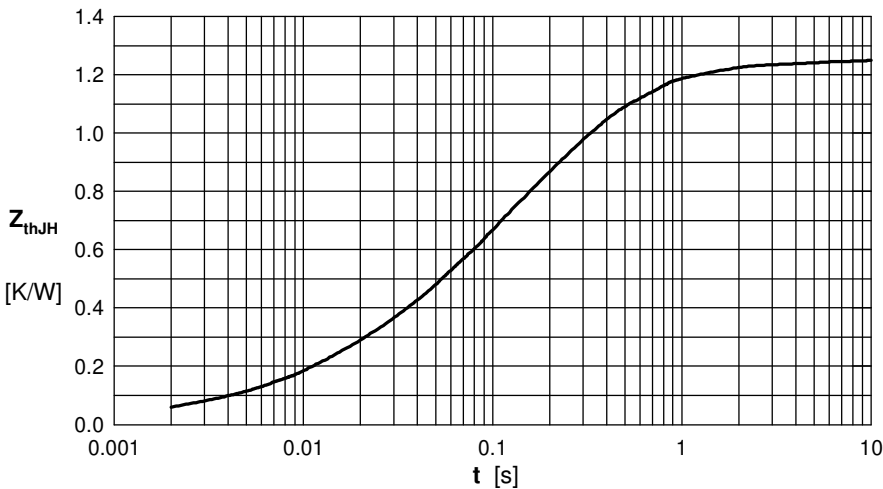

Fig. 6 Transient thermal impedance junction

Note: All curves are per diode