

Super Fast Recovery Diode

preliminary data

$$I_{FAVM} = 63 \text{ A}$$

$$V_{RRM} = 1800 \text{ V}$$

$$t_{rr} = 40 \text{ ns}$$

Part number
DSDI60-18A

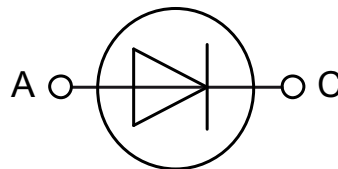
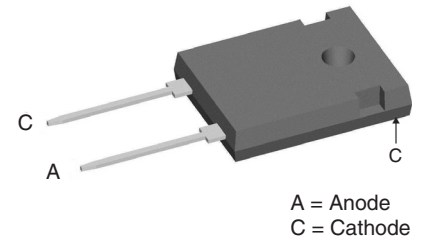

Features / Advantages:

- Planar passivated chips
- Very short recovery time
- Extremely low switching losses
- Low I_{RM} values
- Soft recovery behaviour
- High reliability circuit operation
- Low voltage peaks for reduced protection circuits
- Low noise switching
- Low losses
- Operating at lower temperature or space saving by reduced cooling

Applications:

- Antiparallel diode for high frequency switching devices
- Anti saturation diode
- Snubber diode
- Free wheeling diode in converters and motor control circuits
- Rectifiers in switch mode power supplies (SMPS)
- Inductive heating and melting
- Uninterruptible power supplies (UPS)
- Ultrasonic cleaners and welders

Package: TO-247 AD

- International standard package JEDEC TO-247 AD
- Creepage distance between leads 8.5 mm
- Epoxy meets UL 94V-0

Disclaimer Notice

Information furnished is believed to be accurate and reliable. However, users should independently evaluate the suitability of and test each product selected for their own applications. Littelfuse products are not designed for, and may not be used in, all applications. Read complete Disclaimer Notice at www.littelfuse.com/disclaimer-electronics.



preliminary data

Diode				Ratings			
Symbol	Definitions	Conditions	min.	typ.	max.		
V_{RRM}	max. repetitive reverse voltage				1800	V	
V_{RSM}	max. non-repetitive reverse voltage				1800	V	
I_{FRMS}	RMS forward current		$T_{VJ} = 150^{\circ}\text{C}$		100	A	
I_{FAVM} ①	max. average forward current	rectangular, d = 0.5	$T_C = 60^{\circ}\text{C}$		63	A	
I_{FRM}	max. repetitive forward current	$t_p < 10 \mu\text{s}$ rep. rating, pulse width limited by T_{VJM}			800	A	
I_{FSM}	max. surge forward current	t = 10 ms (50 Hz), sine	$T_{VJ} = 45^{\circ}\text{C}$		500	A	
		t = 8.3 ms (60 Hz), sine			540	A	
		t = 10 ms (50 Hz), sine	$T_{VJ} = 150^{\circ}\text{C}$		450	A	
		t = 8.3 ms (60 Hz), sine			480	A	
I^2t	I^2t value for fusing	t = 10 ms (50 Hz), sine	$T_{VJ} = 45^{\circ}\text{C}$		1250	A ² s	
		t = 8.3 ms (60 Hz), sine			1200	A ² s	
		t = 10 ms (50 Hz), sine	$T_{VJ} = 150^{\circ}\text{C}$		1000	A ² s	
		t = 8.3 ms (60 Hz), sine			950	A ² s	
I_R	reverse current	$V_R = V_{RRM}$	$T_{VJ} = 25^{\circ}\text{C}$	1	2	mA	
		$V_R = 0.8 \cdot V_{RRM}$	$T_{VJ} = 25^{\circ}\text{C}$	0.5		mA	
		$V_R = 0.8 \cdot V_{RRM}$	$T_{VJ} = 125^{\circ}\text{C}$	3		mA	
V_F	forward voltage	$I_F = 70 \text{ A}$	$T_{VJ} = 125^{\circ}\text{C}$	2.6		V	
			$T_{VJ} = 25^{\circ}\text{C}$		4.1	V	
V_{TO}	threshold voltage		$T_{VJ} = 150^{\circ}\text{C}$		1.9	V	
r_T	slope resistance	for power-loss calculations only	$T_{VJ} = 150^{\circ}\text{C}$		10	mΩ	
P_{tot}	total power dissipation		$T_{VJ} = 25^{\circ}\text{C}$		416	W	
R_{thJC}	thermal resistance junction to case				0.4	K/W	
R_{thCH}	thermal resistance junction to heatsink			0.25		K/W	
t_{rr}	reverse recovery time	$I_F = 1 \text{ A}; -di/dt = 200 \text{ A}/\mu\text{s}; V_R = 30 \text{ V}$	$T_{VJ} = 25^{\circ}\text{C}$		40	ns	
t_{rr}	reverse recovery time	$I_F = 70 \text{ A}; -di_F/dt = 500 \text{ A}/\mu\text{s}$	$T_{VJ} = 25^{\circ}\text{C}$		300	ns	
I_{RM}	max. reverse recovery current	$V_R = 1000 \text{ V}$			60	A	
t_{rr}	reverse recovery time	$I_F = 70 \text{ A}; -di_F/dt = 500 \text{ A}/\mu\text{s}$	$T_{VJ} = 125^{\circ}\text{C}$		400	ns	
I_{RM}	max. reverse recovery current	$V_R = 1000 \text{ V}$			85	A	

① I_{FAVM} rating includes reverse blocking losses at T_{VJM} , $V_R = 0.8 V_{RRM}$, duty cycle d = 0.5

preliminary data

Package TO-247 AD			Ratings			
Symbol	Definitions	Conditions	min.	typ.	max.	
I_{RMS}	RMS current				70	A
T_{VJ}	virtual junction temperature		-40		150	°C
T_{op}	operation temperature		-40		125	°C
T_{stg}	storage temperature		-40		150	°C
Weight				6		g
M_D	mounting torque		0.8		1.2	Nm
F_c	mounting force with clip		20		120	N

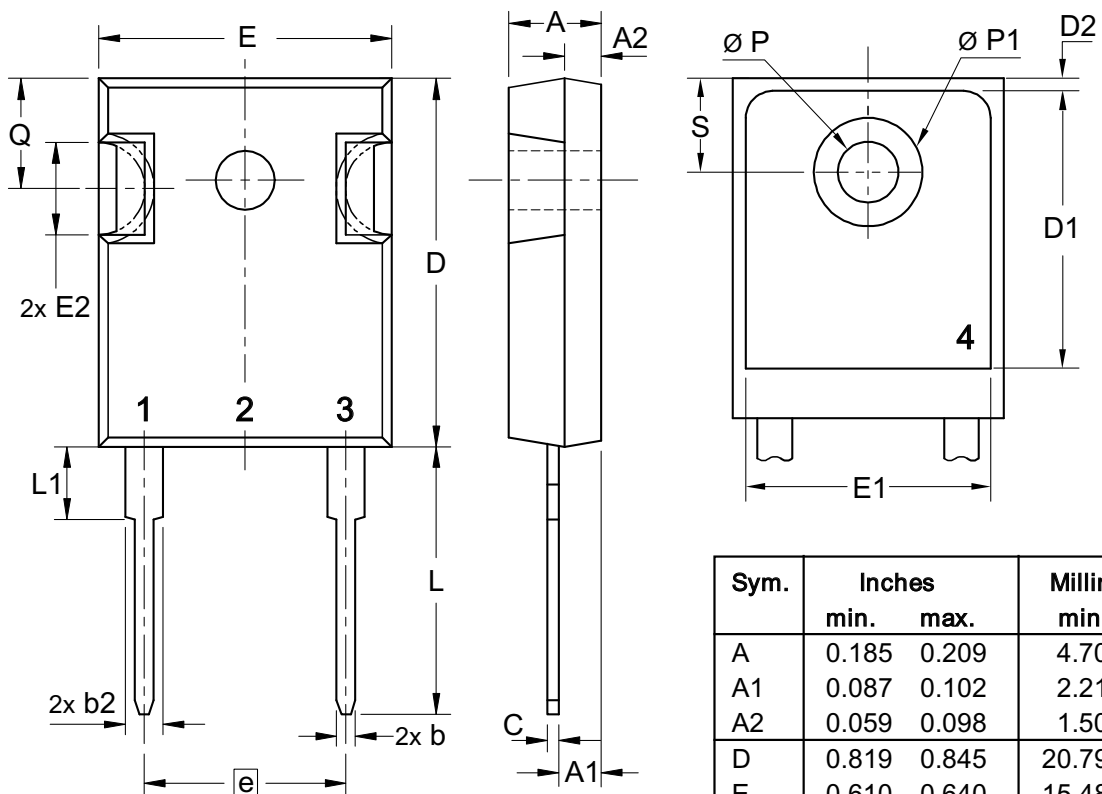

Sym.	Inches		Millimeter	
	min.	max.	min.	max.
A	0.185	0.209	4.70	5.30
A1	0.087	0.102	2.21	2.59
A2	0.059	0.098	1.50	2.49
D	0.819	0.845	20.79	21.45
E	0.610	0.640	15.48	16.24
E2	0.170	0.216	4.31	5.48
e	0.430 BSC		10.92 BSC	
L	0.780	0.800	19.80	20.30
L1	-	0.177	-	4.49
Ø P	0.140	0.144	3.55	3.65
Q	0.212	0.244	5.38	6.19
S	0.242 BSC		6.14 BSC	
b	0.039	0.055	0.99	1.40
b2	0.065	0.094	1.65	2.39
b4	0.102	0.135	2.59	3.43
c	0.015	0.035	0.38	0.89
D1	0.515	-	13.07	-
D2	0.020	0.053	0.51	1.35
E1	0.530	-	13.45	-
Ø P1	-	0.29	-	7.39

