



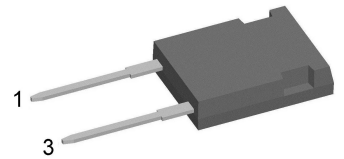
HiPerDynFRED

$V_{RRM} = 1200\text{ V}$
 $I_{FAV} = 15\text{ A}$
 $t_{rr} = 15\text{ ns}$

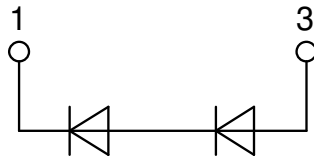
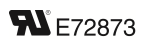
High Performance Dynamic Fast Recovery Diode
 Extreme Low Loss and Soft Recovery
 Single Diode

Part number

DSEP15-12CR



Backside: isolated



Features / Advantages:

- Planar passivated chips
- Very low leakage current
- Very short recovery time
- Improved thermal behaviour
- Very low I_{rm}-values
- Very soft recovery behaviour
- Soft reverse recovery for low EMI/RFI
- Low I_{rm} reduces:
 - Power dissipation within the diode
 - Turn-on loss in the commutating switch

Applications:

- Antiparallel diode for high frequency switching devices
- Antisaturation diode
- Snubber diode
- Free wheeling diode
- Rectifiers in switch mode power supplies (SMPS)
- Uninterruptible power supplies (UPS)

Package: ISOPLUS247

- Isolation Voltage: 3600 V~
- Industry standard outline
- RoHS compliant
- Epoxy meets UL 94V-0
- Soldering pins for PCB mounting
- Backside: DCB ceramic
- Reduced weight
- Advanced power cycling

Disclaimer Notice

Information furnished is believed to be accurate and reliable. However, users should independently evaluate the suitability of and test each product selected for their own applications. Littelfuse products are not designed for, and may not be used in, all applications. Read complete Disclaimer Notice at www.littelfuse.com/disclaimer-electronics.

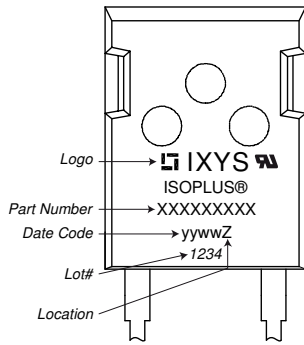


| Fast Diode | | | | Ratings | | | |
|------------|--|---|-------------------------|---------|------|------------|--|
| Symbol | Definition | Conditions | min. | typ. | max. | Unit | |
| V_{RSM} | max. non-repetitive reverse blocking voltage | $T_{VJ} = 25^{\circ}C$ | | | 1200 | V | |
| V_{RRM} | max. repetitive reverse blocking voltage | $T_{VJ} = 25^{\circ}C$ | | | 1200 | V | |
| I_R | reverse current, drain current | $V_R = 1200 V$ | $T_{VJ} = 25^{\circ}C$ | | 100 | μA | |
| | | $V_R = 1200 V$ | $T_{VJ} = 150^{\circ}C$ | | 0.5 | mA | |
| V_F | forward voltage drop | $I_F = 15 A$ | $T_{VJ} = 25^{\circ}C$ | | 4.04 | V | |
| | | $I_F = 30 A$ | | | 4.45 | V | |
| | | $I_F = 15 A$ | $T_{VJ} = 150^{\circ}C$ | | 2.67 | V | |
| | | $I_F = 30 A$ | | | 3.10 | V | |
| I_{FAV} | average forward current | $T_C = 135^{\circ}C$ rectangular $d = 0.5$ | $T_{VJ} = 175^{\circ}C$ | | 15 | A | |
| V_{FO} | threshold voltage | } for power loss calculation only | $T_{VJ} = 175^{\circ}C$ | | 1.82 | V | |
| r_F | slope resistance | | | | 29.8 | m Ω | |
| R_{thJC} | thermal resistance junction to case | | | | 1 | K/W | |
| R_{thCH} | thermal resistance case to heatsink | | | 0.3 | | K/W | |
| P_{tot} | total power dissipation | | $T_C = 25^{\circ}C$ | | 150 | W | |
| I_{FSM} | max. forward surge current | $t = 10 ms; (50 Hz), sine; V_R = 0 V$ | $T_{VJ} = 45^{\circ}C$ | | 110 | A | |
| C_J | junction capacitance | $V_R = 400 V \quad f = 1 MHz$ | $T_{VJ} = 25^{\circ}C$ | | 9 | pF | |
| I_{RM} | max. reverse recovery current | } $I_F = 15 A; V_R = 800 V$ $-di_F / dt = 600 A/\mu s$ | $T_{VJ} = 25^{\circ}C$ | | 10 | A | |
| | | | $T_{VJ} = 125^{\circ}C$ | | 15 | A | |
| t_{rr} | reverse recovery time | | $T_{VJ} = 25^{\circ}C$ | | 15 | ns | |
| | | | $T_{VJ} = 125^{\circ}C$ | | 110 | ns | |



| Package ISOPLUS247 | | Ratings | | | | |
|--------------------|--|-------------------------------------|--------------|------|------|------|
| Symbol | Definition | Conditions | min. | typ. | max. | Unit |
| I_{RMS} | RMS current | per terminal | | | 70 | A |
| T_{VJ} | virtual junction temperature | | -55 | | 175 | °C |
| T_{op} | operation temperature | | -55 | | 150 | °C |
| T_{stg} | storage temperature | | -55 | | 150 | °C |
| Weight | | | | 6 | | g |
| F_C | mounting force with clip | | 20 | | 120 | N |
| $d_{Spp/ App}$ | creepage distance on surface / striking distance through air | terminal to terminal | 5.4 | | | mm |
| $d_{Spb/ Apb}$ | | terminal to backside | 4.1 | | | mm |
| V_{ISOL} | isolation voltage | t = 1 second t = 1 minute | 3600 3000 | | | V |
| | | 50/60 Hz, RMS; $I_{ISOL} \leq 1$ mA | | | | V |

Product Marking



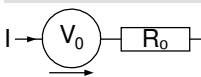
| Ordering | Ordering Number | Marking on Product | Delivery Mode | Quantity | Code No. |
|----------|-----------------|--------------------|---------------|----------|----------|
| Standard | DSEP15-12CR | DSEP15-12CR | Tube | 30 | 482137 |

| Similar Part | Package | Voltage class |
|--------------|--------------|---------------|
| DSEP12-12A | TO-220AC (2) | 1200 |
| DSEP12-12B | TO-220AC (2) | 1200 |

Equivalent Circuits for Simulation

* on die level

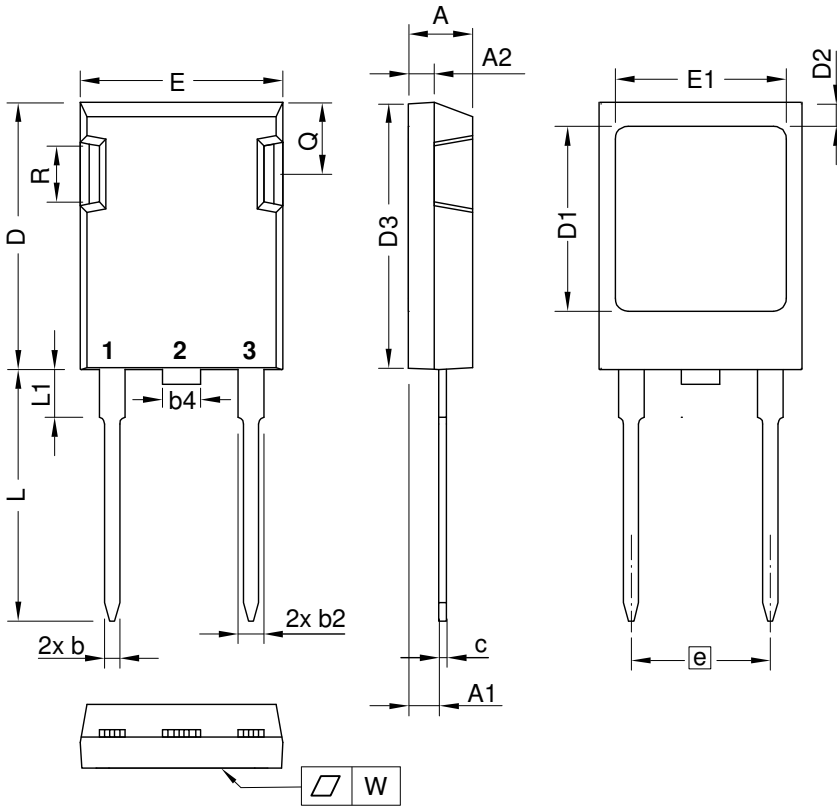
$T_{VJ} = 175^{\circ}C$



| Symbol | Definition | Value | Unit |
|--------------|--------------------|-------|------|
| $V_{0\ max}$ | threshold voltage | 1.82 | V |
| $R_{0\ max}$ | slope resistance * | 23.5 | mΩ |



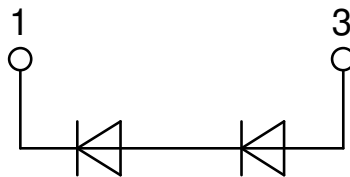
Outlines ISOPLUS247



| Dim. | Millimeter | | Inches | |
|------|------------|-------|-----------|-------|
| | min | max | min | max |
| A | 4.83 | 5.21 | 0.190 | 0.205 |
| A1 | 2.29 | 2.54 | 0.090 | 0.100 |
| A2 | 1.91 | 2.16 | 0.075 | 0.085 |
| b | 1.14 | 1.40 | 0.045 | 0.055 |
| b2 | 1.91 | 2.20 | 0.075 | 0.087 |
| b4 | 2.92 | 3.24 | 0.115 | 0.128 |
| c | 0.61 | 0.83 | 0.024 | 0.033 |
| D | 20.80 | 21.34 | 0.819 | 0.840 |
| D1 | 15.75 | 16.26 | 0.620 | 0.640 |
| D2 | 1.65 | 2.15 | 0.065 | 0.085 |
| D3 | 20.30 | 20.70 | 0.799 | 0.815 |
| E | 15.75 | 16.13 | 0.620 | 0.635 |
| E1 | 13.21 | 13.72 | 0.520 | 0.540 |
| e | 10.90 BSC | | 0.429 BSC | |
| L | 19.81 | 20.60 | 0.780 | 0.811 |
| L1 | 3.81 | 4.38 | 0.150 | 0.172 |
| Q | 5.59 | 6.20 | 0.220 | 0.244 |
| R | 4.25 | 5.50 | 0.167 | 0.217 |
| W | - | 0.10 | - | 0.004 |

Die konvexe Form des Substrates ist typ. < 0.04 mm über der Kunststoffoberfläche der Bauteilunterseite
The convex bow of substrate is typ. < 0.04 mm over plastic surface level of device bottom side

Die Gehäuseabmessungen entsprechen dem Typ TO-247 AD gemäß JEDEC außer Schraubloch und L_{max} .
This drawing will meet all dimensions requirement of JEDEC outline TO-247 AD except screw hole and except L_{max} .



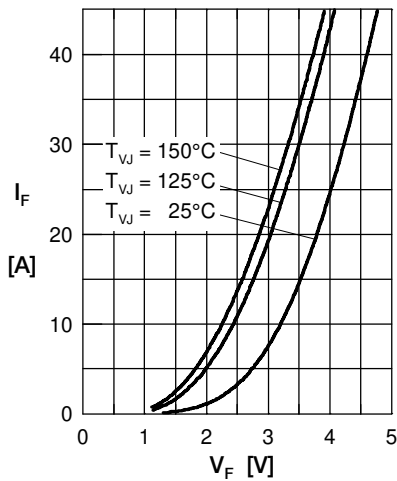
Fast Diode


Fig. 1 Forward current I_F versus V_F

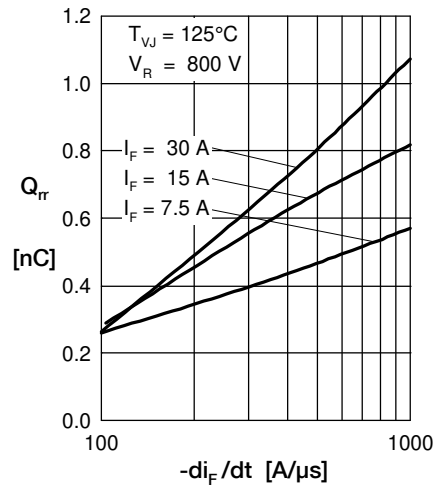


Fig. 2 Typ. reverse recov charge Q_r versus $-di_F/dt$

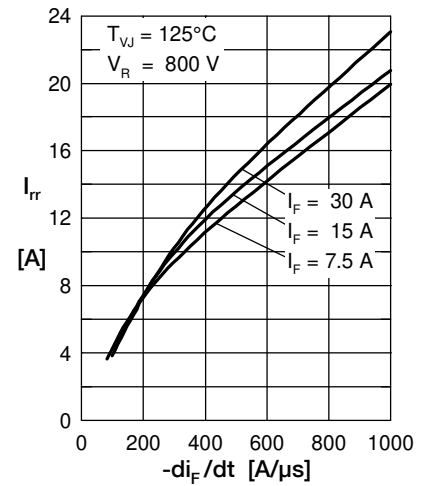


Fig. 3 Peak reverse current I_{RM} versus $-di_F/dt$

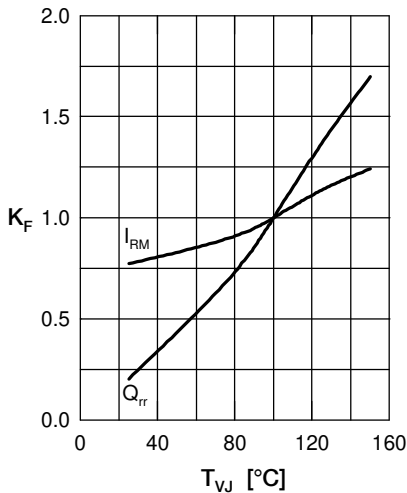


Fig. 4 Typ. dynamic parameters Q_r , I_{RM} versus T_{VJ}

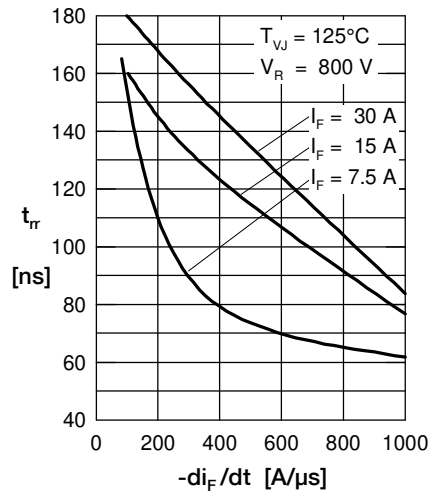


Fig. 5 Typ. recovery time t_{rr} versus $-di_F/dt$

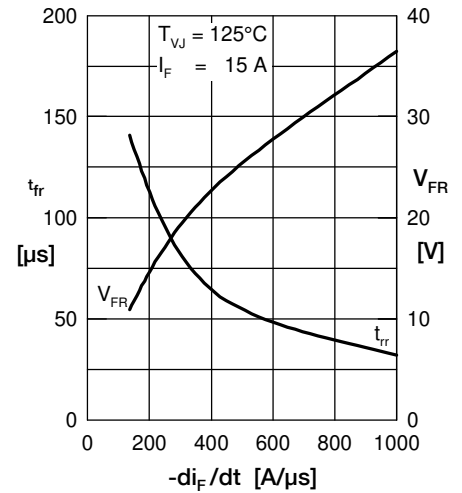


Fig. 6 Typ. peak forward voltage V_{FR} and t_{rr} versus di_F/dt

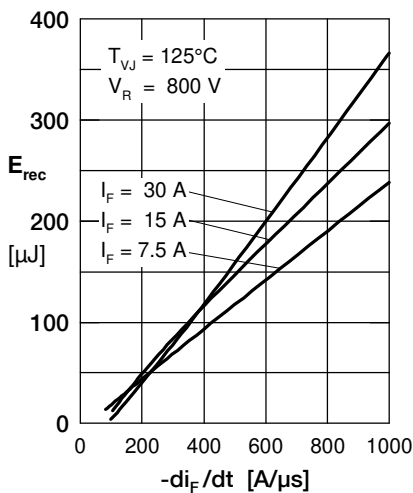


Fig. 7 Typ. recovery energy E_{rec} versus $-di_F/dt$

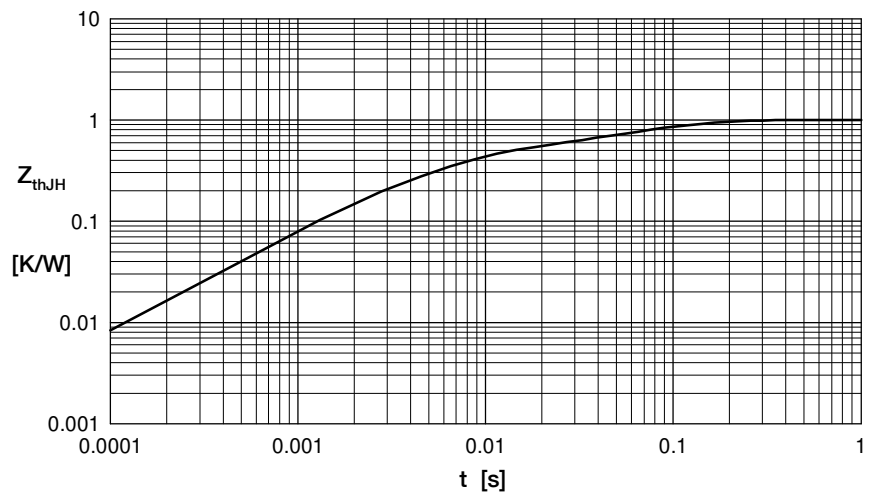


Fig. 8 Transient thermal resistance junction to case