

HiPerFRED

$$V_{RRM} = 1200\text{ V}$$

$$I_{FAV} = 60\text{ A}$$

$$t_{rr} = 40\text{ ns}$$

High Performance Fast Recovery Diode
 Low Loss and Soft Recovery
 Single Diode

Part number

DSEP60-12AZ

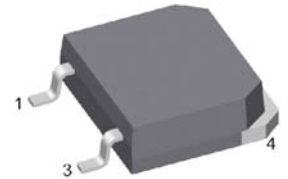

Backside: cathode

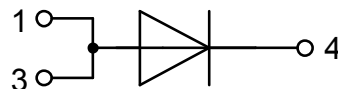

Features / Advantages:

- Planar passivated chips
- Very low leakage current
- Very short recovery time
- Improved thermal behaviour
- Very low I_{rm} -values
- Very soft recovery behaviour
- Avalanche voltage rated for reliable operation
- Soft reverse recovery for low EMI/RFI
- Low I_{rm} reduces:
 - Power dissipation within the diode
 - Turn-on loss in the commutating switch

Applications:

- Antiparallel diode for high frequency switching devices
- Antisaturation diode
- Snubber diode
- Free wheeling diode
- Rectifiers in switch mode power supplies (SMPS)
- Uninterruptible power supplies (UPS)

Package: TO-268AA (D3Pak-HV)

- Industry standard outline
- RoHS compliant
- Epoxy meets UL 94V-0

Disclaimer Notice

Information furnished is believed to be accurate and reliable. However, users should independently evaluate the suitability of and test each product selected for their own applications. Littelfuse products are not designed for, and may not be used in, all applications. Read complete Disclaimer Notice at www.littelfuse.com/disclaimer-electronics.



Fast Diode				Ratings			
Symbol	Definition	Conditions	min.	typ.	max.	Unit	
V_{RSM}	max. non-repetitive reverse blocking voltage	$T_{VJ} = 25^{\circ}C$			1200	V	
V_{RRM}	max. repetitive reverse blocking voltage	$T_{VJ} = 25^{\circ}C$			1200	V	
I_R	reverse current, drain current	$V_R = 1200 V$	$T_{VJ} = 25^{\circ}C$		650	μA	
		$V_R = 1200 V$	$T_{VJ} = 150^{\circ}C$		2,5	mA	
V_F	forward voltage drop	$I_F = 60 A$	$T_{VJ} = 25^{\circ}C$		2,66	V	
		$I_F = 120 A$			3,18	V	
		$I_F = 60 A$	$T_{VJ} = 150^{\circ}C$		1,81	V	
		$I_F = 120 A$			2,40	V	
I_{FAV}	average forward current	$T_C = 115^{\circ}C$ rectangular $d = 0.5$	$T_{VJ} = 175^{\circ}C$		60	A	
V_{FO}	threshold voltage	} for power loss calculation only	$T_{VJ} = 175^{\circ}C$		1,08	V	
r_F	slope resistance				9,4	m Ω	
R_{thJC}	thermal resistance junction to case				0,45	K/W	
R_{thCH}	thermal resistance case to heatsink			0,15		K/W	
P_{tot}	total power dissipation		$T_C = 25^{\circ}C$		330	W	
I_{FSM}	max. forward surge current	$t = 10 ms; (50 Hz), sine; V_R = 0 V$	$T_{VJ} = 45^{\circ}C$		500	A	
C_J	junction capacitance	$V_R = 600 V$ $f = 1 MHz$	$T_{VJ} = 25^{\circ}C$		30	pF	
I_{RM}	max. reverse recovery current	} $I_F = 60 A; V_R = 600 V$ $-di_F/dt = 200 A/\mu s$	$T_{VJ} = 25^{\circ}C$		13	A	
			$T_{VJ} = 100^{\circ}C$		20	A	
t_{rr}	reverse recovery time		$T_{VJ} = 25^{\circ}C$		80	ns	
			$T_{VJ} = 100^{\circ}C$		220	ns	



Package TO-268AA (D3Pak-HV)			Ratings			
Symbol	Definition	Conditions	min.	typ.	max.	Unit
I_{RMS}	RMS current	per terminal			70	A
T_{VJ}	virtual junction temperature		-55		175	°C
T_{op}	operation temperature		-55		150	°C
T_{stg}	storage temperature		-55		150	°C
Weight				4		g
F_C	mounting force with clip		20		120	N
$d_{Spp/App}$	creepage distance on surface striking distance through air	terminal to terminal	9,4			mm
$d_{Spb/Apb}$		terminal to backside	5,6			mm

Product Marking

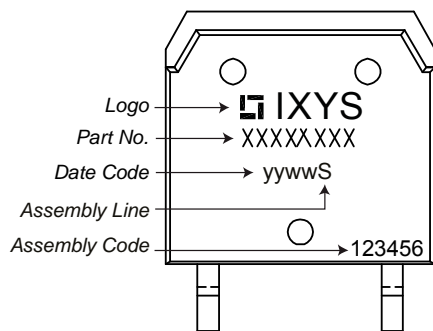

Ordering	Ordering Number	Marking on Product	Delivery Mode	Quantity	Code No.
Standard	DSEP60-12AZ-TUB	DSEP60-12AZ-TUB	Tube	30	522712

Similar Part	Package	Voltage class
DSEP90-12AZ	TO-268AA (D3Pak) (2HV)	1200
DSEI120-12AZ	TO-268AA (D3Pak) (2HV)	1200

Equivalent Circuits for Simulation

* on die level

$T_{VJ} = 175^{\circ}C$

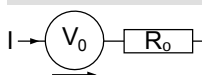

Fast Diode

$V_{0 \max}$	threshold voltage	1,08	V
$R_{0 \max}$	slope resistance *	6,8	mΩ



Outlines TO-268AA (D3Pak-HV)

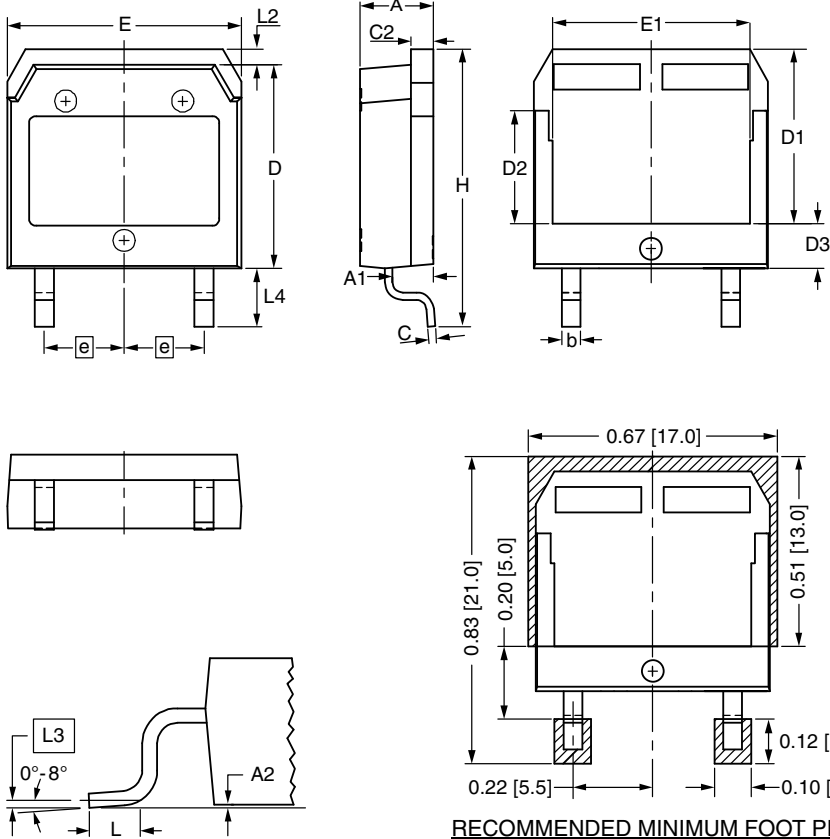

Dim.	Millimeter		Inches	
	min	max	min	max
A	4.90	5.10	0.193	0.201
A1	2.70	2.90	0.106	0.114
A2	0.02	0.25	0.001	0.010
b	1.15	1.45	0.045	0.057
C	0.40	0.65	0.016	0.026
C2	1.45	1.60	0.057	0.063
D	13.80	14.00	0.543	0.551
D1	11.80	12.10	0.465	0.476
D2	7.50	7.80	0.295	0.307
D3	2.90	3.20	0.114	0.126
E	15.85	16.05	0.624	0.632
E1	13.30	13.60	0.524	0.535
e	5.450 BSC		0.215 BSC	
H	18.70	19.10	0.736	0.752
L	1.70	2.00	0.067	0.079
L2	1.00	1.15	0.039	0.045
L3	0.250 BSC		0.010 BSC	
L4	3.80	4.10	0.150	0.161

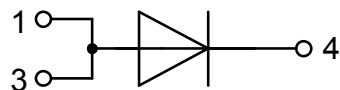

Fast Diode

 Fig. 1 Forward current I_F versus V_F

 Fig. 2 Typ. reverse recov. charge Q_r versus $-di_F/dt$

 Fig. 3 Typ. peak reverse current I_{RM} versus $-di_F/dt$

 Fig. 4 Typ. dynamic parameters Q_r , I_{RM} versus T_{VJ}

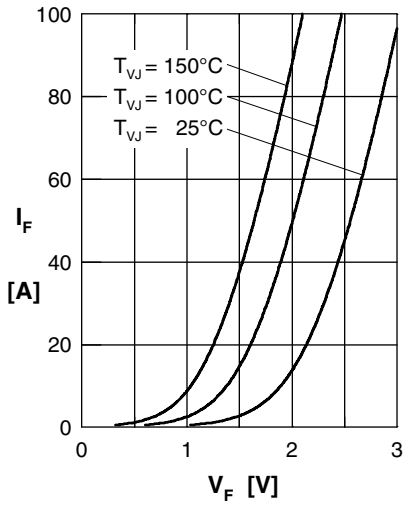
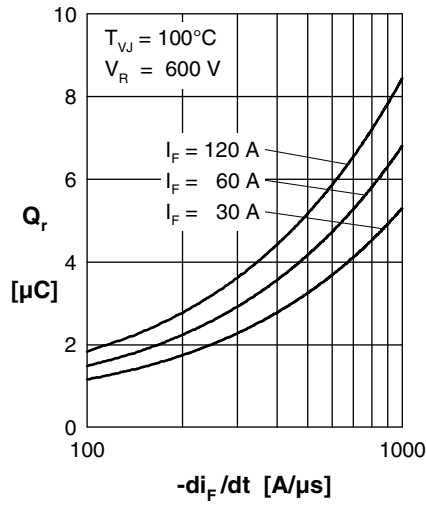
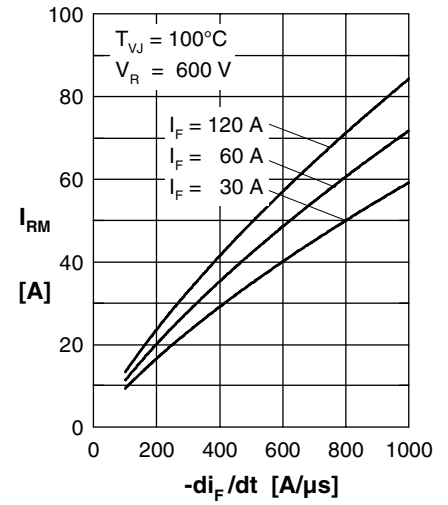
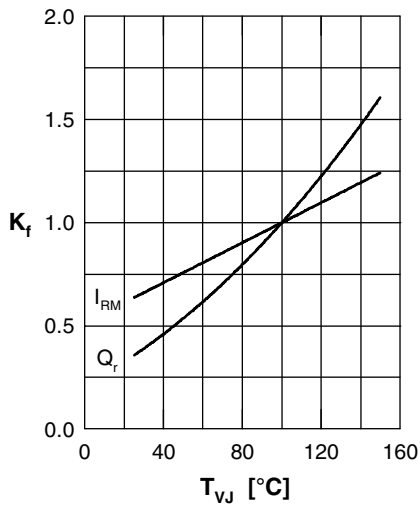
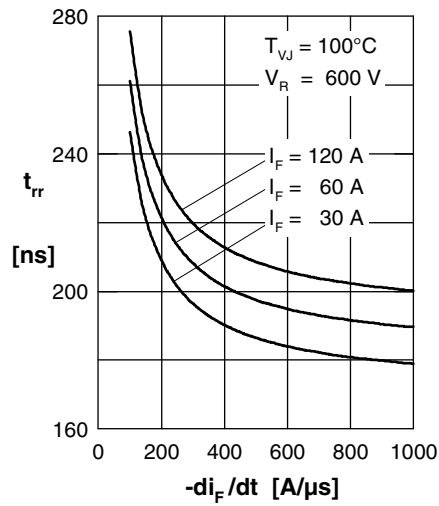
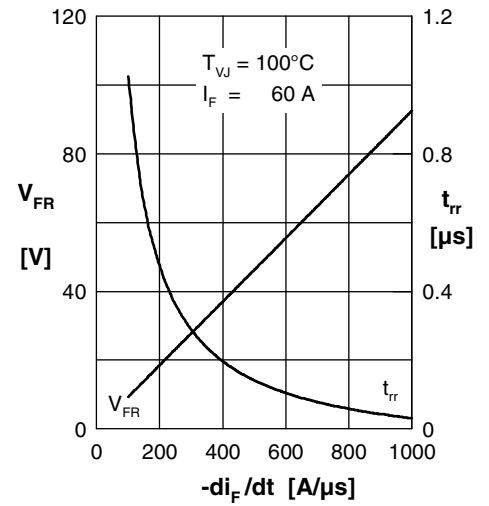
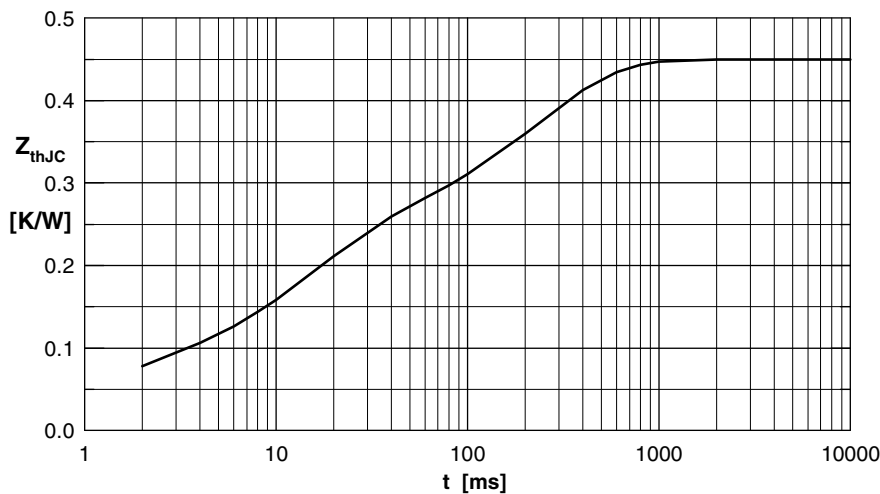
 Fig. 5 Typ. recovery time t_{rr} versus $-di_F/dt$

 Fig. 6 Typ. peak forward voltage V_{FR} and t_{rr} versus di_F/dt

Fig. 7 Transient thermal resistance junction to case

 Constants for Z_{thJC} calculation:

i	R_{thi} (K/W)	t_i (s)
1	0.0050	0.0001
2	0.0550	0.0010
3	0.1750	0.0140
4	0.2150	0.2300