



Standard Rectifier

$$V_{RRM} = 2 \times 1200 \text{ V}$$

$$I_{FAV} = 25 \text{ A}$$

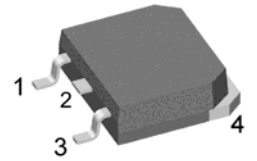
$$V_F = 1,16 \text{ V}$$

Phase leg

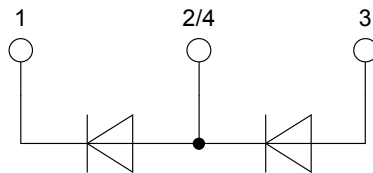
Part number

DSP25-12AT

Marking on Product: DSP25-12AT



Backside: anode/cathode



Features / Advantages:

- Planar passivated chips
- Very low leakage current
- Very low forward voltage drop
- Improved thermal behaviour

Applications:

- Diode for main rectification
- For single and three phase bridge configurations

Package: TO-268AA (D3Pak)

- Industry standard outline
- RoHS compliant
- Epoxy meets UL 94V-0

Disclaimer Notice

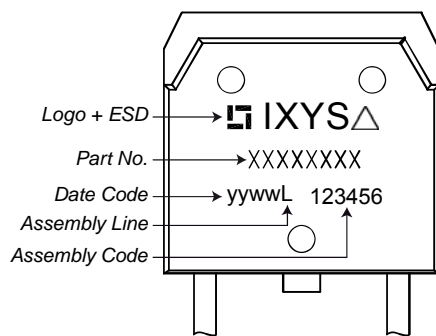
Information furnished is believed to be accurate and reliable. However, users should independently evaluate the suitability of and test each product selected for their own applications. Littelfuse products are not designed for, and may not be used in, all applications. Read complete Disclaimer Notice at www.littelfuse.com/disclaimer-electronics.

Rectifier			Ratings			
Symbol	Definition	Conditions	min.	typ.	max.	Unit
V_{RSM}	max. non-repetitive reverse blocking voltage	$T_{VJ} = 25^{\circ}C$			1300	V
V_{RRM}	max. repetitive reverse blocking voltage	$T_{VJ} = 25^{\circ}C$			1200	V
I_R	reverse current	$V_R = 1200 V$	$T_{VJ} = 25^{\circ}C$		40	μA
		$V_R = 1200 V$	$T_{VJ} = 150^{\circ}C$		1,5	mA
V_F	forward voltage drop	$I_F = 25 A$	$T_{VJ} = 25^{\circ}C$		1,23	V
		$I_F = 50 A$			1,47	V
		$I_F = 25 A$	$T_{VJ} = 150^{\circ}C$		1,16	V
		$I_F = 50 A$			1,50	V
I_{FAV}	average forward current	$T_C = 135^{\circ}C$ 180° sine	$T_{VJ} = 175^{\circ}C$		25	A
V_{F0}	threshold voltage	} for power loss calculation only	$T_{VJ} = 175^{\circ}C$		0,81	V
r_F	slope resistance				13,8	m Ω
R_{thJC}	thermal resistance junction to case				0,9	K/W
R_{thCH}	thermal resistance case to heatsink			0,15		K/W
P_{tot}	total power dissipation		$T_C = 25^{\circ}C$		160	W
I_{FSM}	max. forward surge current	$t = 10 ms; (50 Hz), sine$	$T_{VJ} = 45^{\circ}C$		300	A
		$t = 8,3 ms; (60 Hz), sine$	$V_R = 0 V$		325	A
		$t = 10 ms; (50 Hz), sine$	$T_{VJ} = 150^{\circ}C$		255	A
		$t = 8,3 ms; (60 Hz), sine$	$V_R = 0 V$		275	A
I^2t	value for fusing	$t = 10 ms; (50 Hz), sine$	$T_{VJ} = 45^{\circ}C$		450	A ² s
		$t = 8,3 ms; (60 Hz), sine$	$V_R = 0 V$		440	A ² s
		$t = 10 ms; (50 Hz), sine$	$T_{VJ} = 150^{\circ}C$		325	A ² s
		$t = 8,3 ms; (60 Hz), sine$	$V_R = 0 V$		315	A ² s
C_J	junction capacitance	$V_R = 400 V; f = 1 MHz$	$T_{VJ} = 25^{\circ}C$		10	pF



Package TO-268AA (D3Pak)			Ratings			
Symbol	Definition	Conditions	min.	typ.	max.	Unit
I_{RMS}	RMS current	per terminal			70	A
T_{VJ}	virtual junction temperature		-40		175	°C
T_{op}	operation temperature		-40		150	°C
T_{stg}	storage temperature		-40		150	°C
Weight				5		g
F_C	mounting force with clip		20		120	N

Product Marking



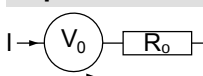
Ordering	Ordering Number	Marking on Product	Delivery Mode	Quantity	Code No.
Standard	DSP25-12AT-TUB	DSP25-12AT	Tube	30	456055
Alternative	DSP25-12AT-TRL	DSP25-12AT	Tape & Reel	400	510578

Similar Part	Package	Voltage class
DSP25-12A	TO-247AD (3)	1200
DSP25-16AT	TO-268AA (D3Pak) (2)	1600
DSP25-16A	TO-247AD (3)	1600
DSP25-16AR	ISOPLUS247 (3)	1600

Equivalent Circuits for Simulation

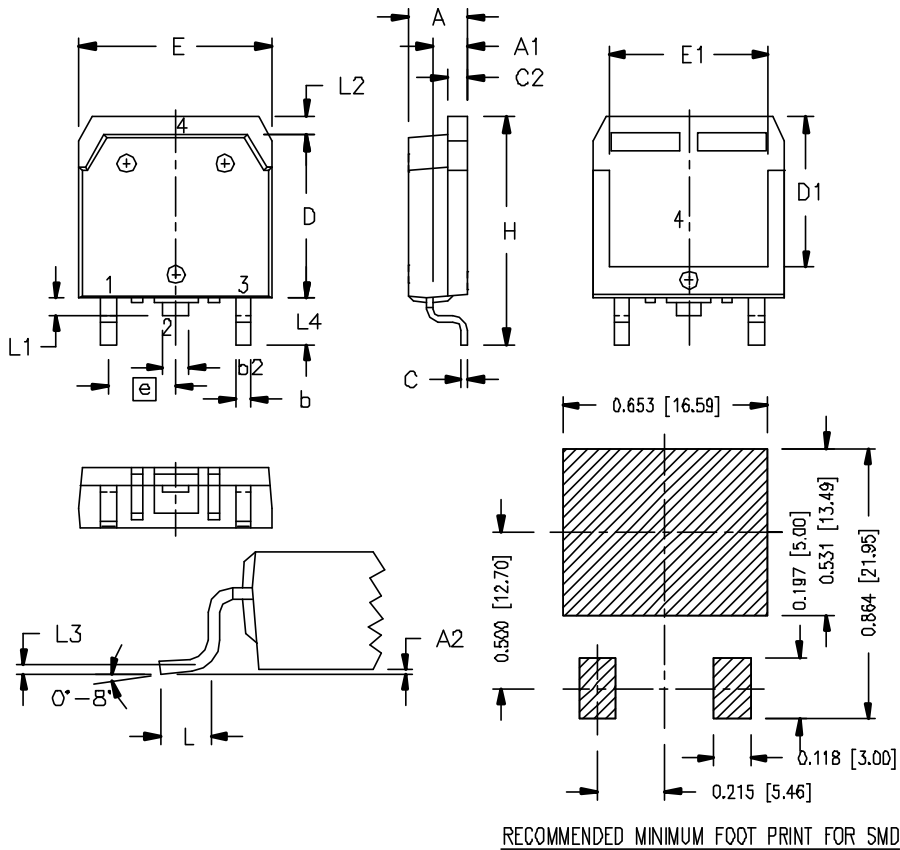
* on die level

$T_{VJ} = 175^{\circ}C$

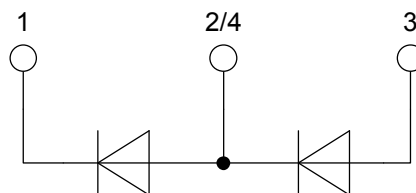


Rectifier

$V_{0\ max}$	threshold voltage	0,81	V
$R_{0\ max}$	slope resistance *	11,2	mΩ

Outlines TO-268AA (D3Pak)


Dim.	Millimeter		Inches	
	min	max	min	max
A	4.90	5.10	0.193	0.201
A1	2.70	2.90	0.106	0.114
A2	0.02	0.25	0.001	0.100
b	1.15	1.45	0.045	0.057
b2	1.90	2.10	0.075	0.083
C	0.40	0.65	0.016	0.026
C2	1.45	1.60	0.057	0.063
D	13.80	14.00	0.543	0.551
D1	12.40	12.70	0.488	0.500
E	15.85	16.05	0.624	0.632
E1	13.30	13.60	0.524	0.535
e	5.45 BSC		0.215 BSC	
H	18.70	19.10	0.736	0.752
L	2.40	2.70	0.094	0.106
L1	1.20	1.40	0.047	0.055
L2	1.00	1.15	0.039	0.045
L3	0.25 BSC		0.100 BSC	
L4	3.80	4.10	0.150	0.161



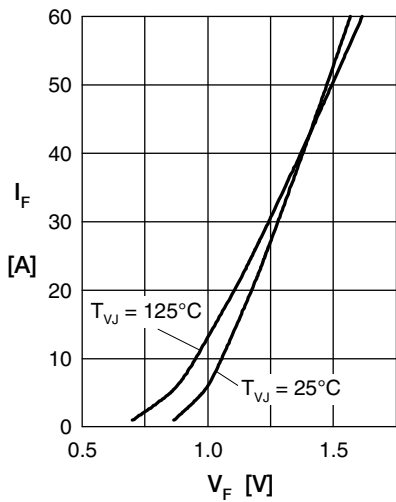
Rectifier


Fig. 1 Forward current versus voltage drop per diode

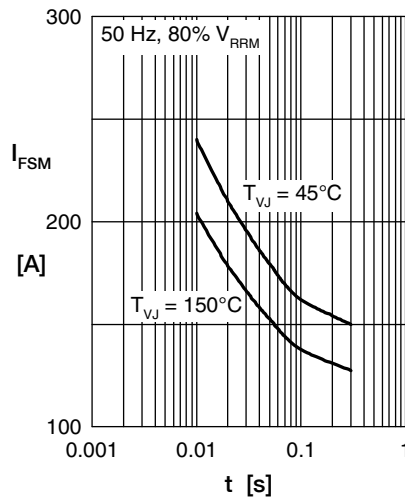


Fig. 2 Surge overload current

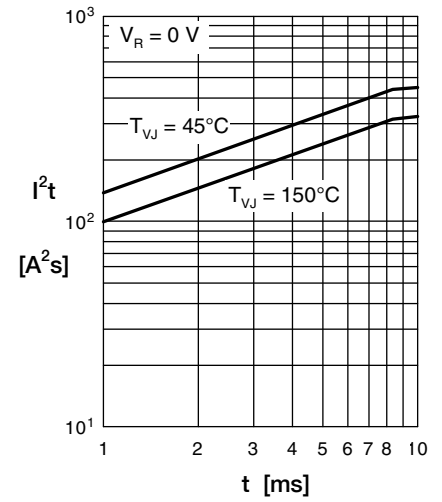
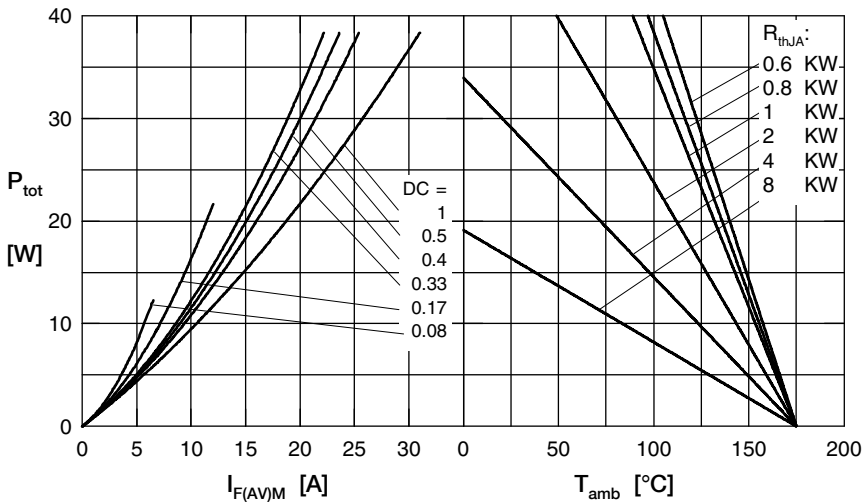

 Fig. 3 I^2t versus time per diode


Fig. 4 Power dissipation vs. direct output current and ambient temperature

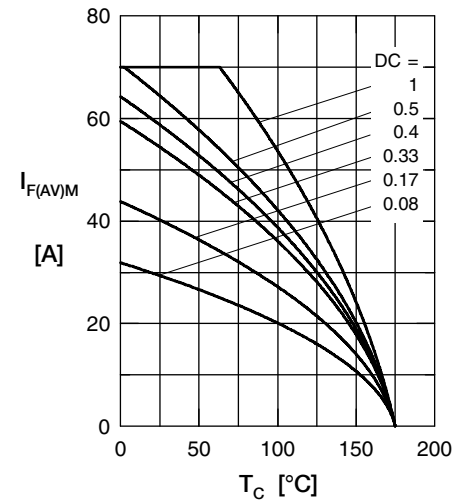


Fig. 5 Max. forward current vs. case temperature

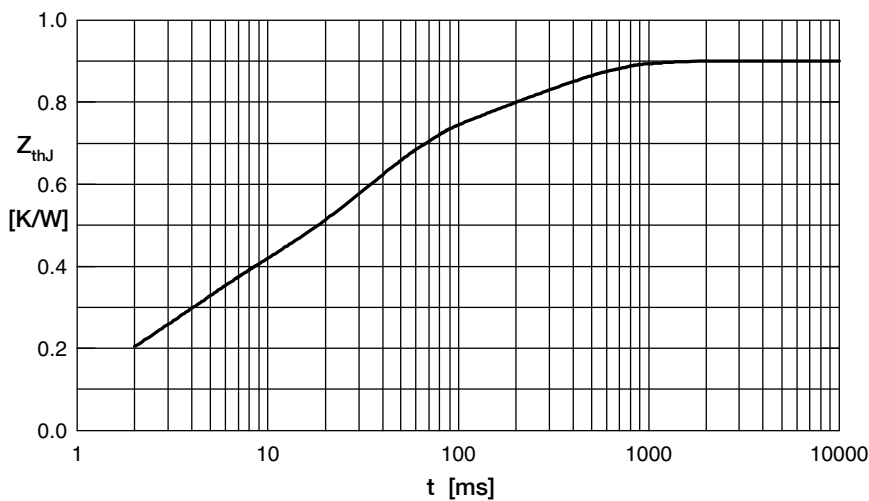


Fig. 6 Transient thermal impedance junction to case

 Constants for Z_{thJC} calculation:

i	R_{thi} (K/W)	t_i (s)
1	0.03	0.0004
2	0.08	0.002
3	0.2	0.003
4	0.39	0.03
5	0.2	0.29