



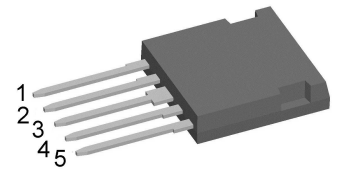
# Standard Rectifier

<b>3~ Rectifier</b>	
$V_{RRM}$	= 1600 V
$I_{DAV}$	= 50 A
$I_{FSM}$	= 270 A

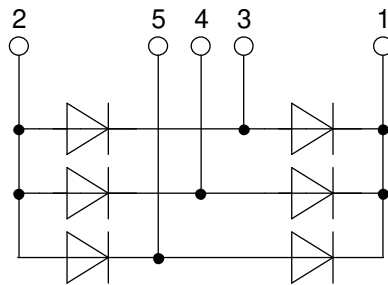
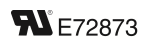
## 3~ Rectifier Bridge

**Part number**

**FUO50-16N**



Backside: isolated



### Features / Advantages:

- Package with DCB ceramic
- Improved temperature and power cycling
- Planar passivated chips
- Very low forward voltage drop
- Very low leakage current

### Applications:

- Diode for main rectification
- For single and three phase bridge configurations

### Package: i4-Pac

- Isolation Voltage: 3000 V~
- Industry convenient outline
- RoHS compliant
- Epoxy meets UL 94V-0
- Soldering pins for PCB mounting
- Backside: DCB ceramic
- Reduced weight
- Advanced power cycling

### Disclaimer Notice

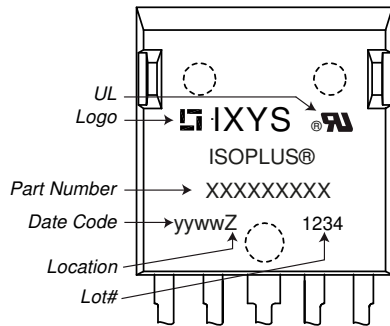
Information furnished is believed to be accurate and reliable. However, users should independently evaluate the suitability of and test each product selected for their own applications. Littelfuse products are not designed for, and may not be used in, all applications. Read complete Disclaimer Notice at [www.littelfuse.com/disclaimer-electronics](http://www.littelfuse.com/disclaimer-electronics).

Rectifier				Ratings			
Symbol	Definition	Conditions		min.	typ.	max.	Unit
$V_{RSM}$	max. non-repetitive reverse blocking voltage					1700	V
$V_{RRM}$	max. repetitive reverse blocking voltage					1600	V
$I_R$	reverse current	$V_R = 1600$ V		$T_{VJ} = 25^\circ\text{C}$		20	$\mu\text{A}$
		$V_R = 1600$ V		$T_{VJ} = 150^\circ\text{C}$		1	mA
$V_F$	forward voltage drop	$I_F = 15$ A		$T_{VJ} = 25^\circ\text{C}$		1.15	V
		$I_F = 45$ A				1.50	V
		$I_F = 15$ A		$T_{VJ} = 150^\circ\text{C}$		1.04	V
		$I_F = 45$ A				1.55	V
$I_{DAV}$	bridge output current	$T_C = 120^\circ\text{C}$		$T_{VJ} = 175^\circ\text{C}$		50	A
		rectangular	$d = \frac{1}{3}$				
$V_{FO}$	threshold voltage			$T_{VJ} = 175^\circ\text{C}$		0.78	V
$r_F$	slope resistance					17	m $\Omega$
						} for power loss calculation only	
$R_{thJC}$	thermal resistance junction to case					2.1	K/W
$R_{thCH}$	thermal resistance case to heatsink				0.2		K/W
$P_{tot}$	total power dissipation			$T_C = 25^\circ\text{C}$		70	W
$I_{FSM}$	max. forward surge current	$t = 10$ ms; (50 Hz), sine		$T_{VJ} = 45^\circ\text{C}$		270	A
		$t = 8,3$ ms; (60 Hz), sine		$V_R = 0$ V		290	A
		$t = 10$ ms; (50 Hz), sine		$T_{VJ} = 150^\circ\text{C}$		230	A
		$t = 8,3$ ms; (60 Hz), sine		$V_R = 0$ V		250	A
$I^2t$	value for fusing	$t = 10$ ms; (50 Hz), sine		$T_{VJ} = 45^\circ\text{C}$		365	A <sup>2</sup> s
		$t = 8,3$ ms; (60 Hz), sine		$V_R = 0$ V		350	A <sup>2</sup> s
		$t = 10$ ms; (50 Hz), sine		$T_{VJ} = 150^\circ\text{C}$		265	A <sup>2</sup> s
		$t = 8,3$ ms; (60 Hz), sine		$V_R = 0$ V		260	A <sup>2</sup> s
$C_J$	junction capacitance	$V_R = 400$ V; $f = 1$ MHz		$T_{VJ} = 25^\circ\text{C}$		8	pF



Package i4-Pac		Ratings				
Symbol	Definition	Conditions	min.	typ.	max.	Unit
$I_{RMS}$	RMS current	per terminal			50	A
$T_{VJ}$	virtual junction temperature		-55		175	°C
$T_{op}$	operation temperature		-55		150	°C
$T_{stg}$	storage temperature		-55		150	°C
<b>Weight</b>				6		g
$F_C$	mounting force with clip		20		120	N
$d_{Spp/ App}$	creepage distance on surface / striking distance through air	terminal to terminal	1.7			mm
$d_{Spb/ Apb}$		terminal to backside	5.1			mm
$V_{ISOL}$	isolation voltage	t = 1 second	3000			V
		t = 1 minute	2500			V

**Product Marking**



Ordering	Ordering Number	Marking on Product	Delivery Mode	Quantity	Code No.
Standard	FUO50-16N	FUO50-16N	Tube	25	498637

**Equivalent Circuits for Simulation**

\* on die level

$T_{VJ} = 175^{\circ}C$

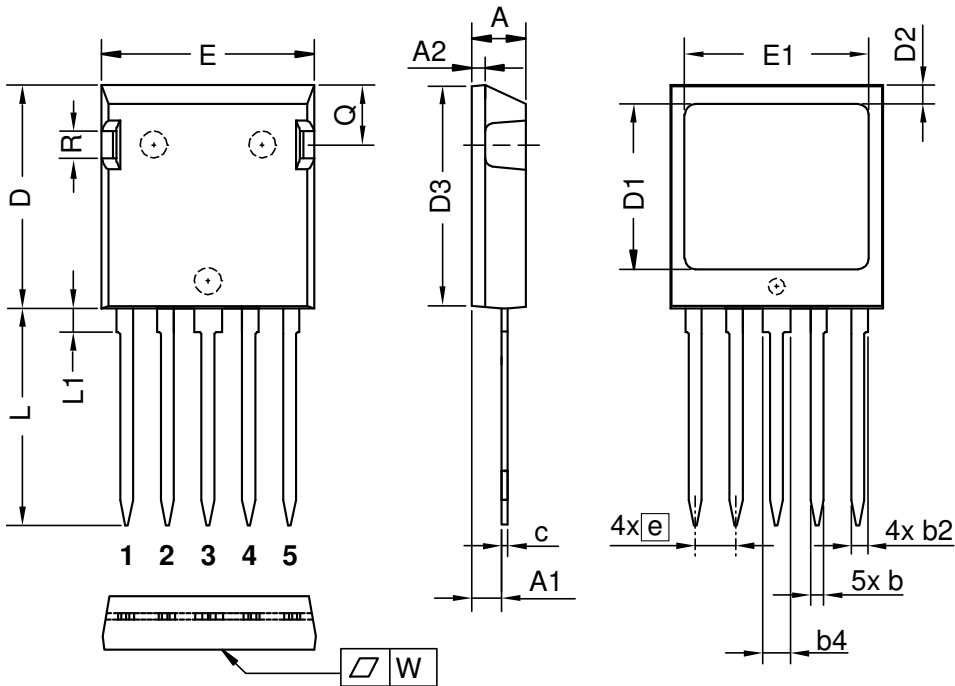


**Rectifier**

$V_{0\ max}$	threshold voltage	0.78	V
$R_{0\ max}$	slope resistance *	14	mΩ

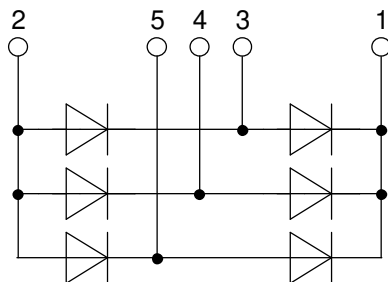


**Outlines i4-Pac**



Dim.	Millimeter		Inches	
	min	max	min	max
A	4.83	5.21	0.190	0.205
A1	2.59	3.00	0.102	0.118
A2	1.17	2.16	0.046	0.085
b	1.14	1.40	0.045	0.055
b2	1.47	1.73	0.058	0.068
b4	2.54	2.79	0.100	0.110
c	0.51	0.74	0.020	0.029
D	20.80	21.34	0.819	0.840
D1	14.99	15.75	0.590	0.620
D2	1.65	2.03	0.065	0.080
D3	20.30	20.70	0.799	0.815
E	19.56	20.29	0.770	0.799
E1	16.76	17.53	0.660	0.690
e	3.81 BSC		0.150 BSC	
L	19.81	21.34	0.780	0.840
L1	2.11	2.59	0.083	0.102
Q	5.33	6.20	0.210	0.244
R	2.54	4.57	0.100	0.180
W	-	0.10	-	0.004

Die konvexe Form des Substrates ist typ. < 0.05 mm über der Kunststoffoberfläche der Bauteilunterseite  
The convexbow of substrate is typ. < 0.05 mm over plastic surface level of device bottom side



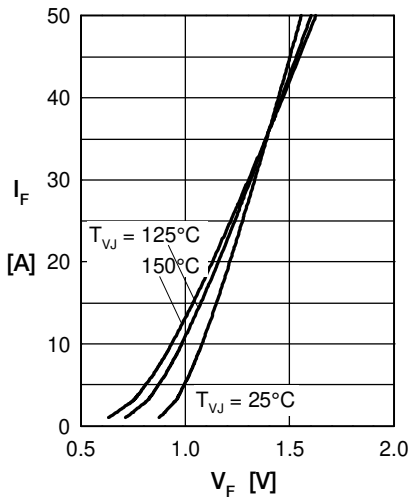
**Rectifier**


Fig. 1 Forward current versus voltage drop per diode

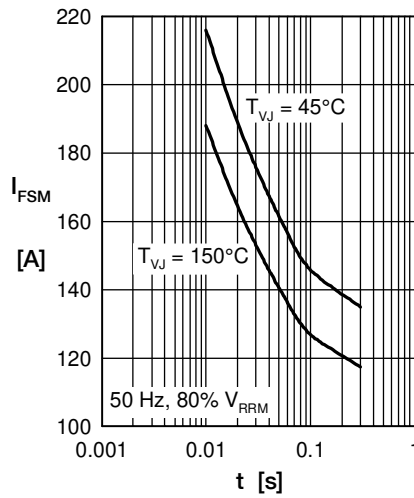


Fig. 2 Surge overload current

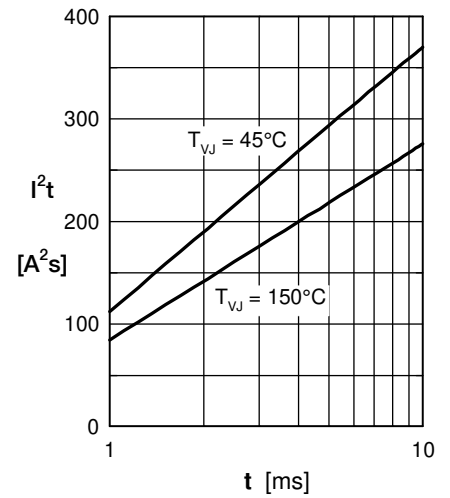
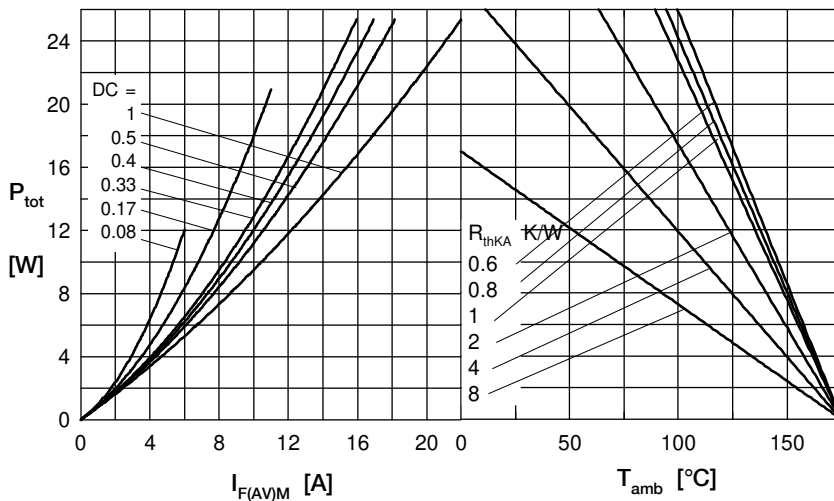

 Fig. 3  $I^2t$  versus time per diode


Fig. 4 Power dissipation vs. direct output current &amp; ambient temperature

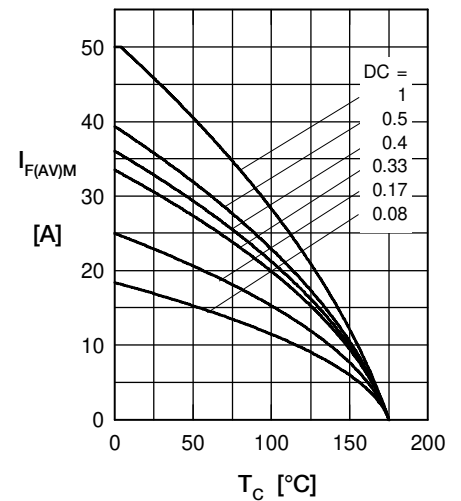


Fig. 5 Max. forward current vs. case temperature

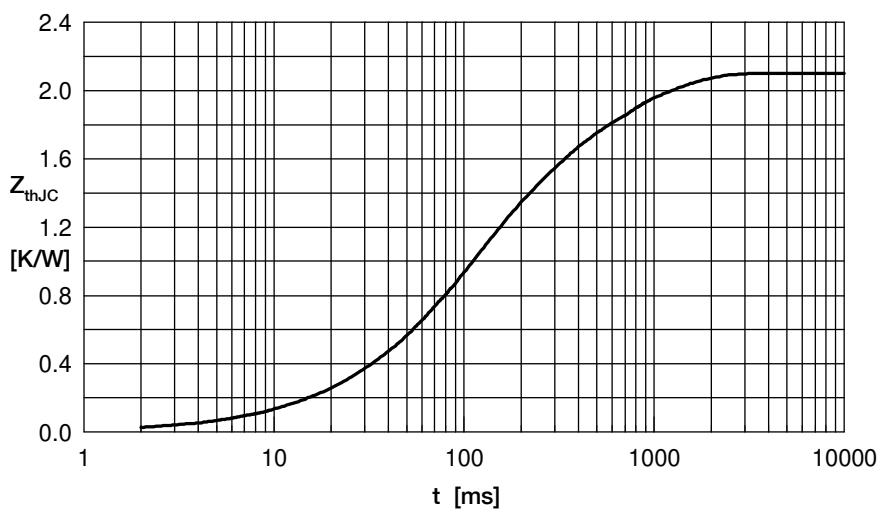


Fig. 6 Transient thermal impedance junction to case

 Constants for  $Z_{thJC}$  calculation:

i	$R_{thi}$ (K/W)	$t_i$ (s)
1	1.159	0.1015
2	0.1286	0.1026
3	0.2651	0.4919
4	0.5473	0.62