

Three phase full Bridge

with Trench MOSFETs
in DCB isolated high current package

$V_{DSS} = 150\text{ V}$
 $I_{D25} = 50\text{ A}$
 $R_{DSon\ typ.} = 19\text{ m}\Omega$

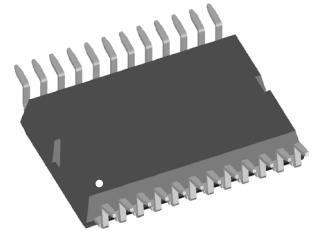
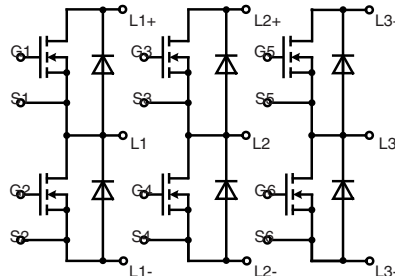

MOSFETs			
Symbol	Conditions	Maximum Ratings	
V_{DSS}	$T_{VJ} = 25^{\circ}\text{C to } 150^{\circ}\text{C}$	150	V
V_{GS}	continous	± 15	V
	transient	± 20	V
I_{D25}	$T_C = 25^{\circ}\text{C}$	50	A
I_{D90}	$T_C = 90^{\circ}\text{C}$	38	A
I_{D110}	$T_C = 110^{\circ}\text{C}$	33	A
I_{F25}	$T_C = 25^{\circ}\text{C}$ (diode)	150	A
I_{F90}	$T_C = 90^{\circ}\text{C}$ (diode)	85	A
I_{F110}	$T_C = 110^{\circ}\text{C}$ (diode)	65	A

Applications

AC drives

- in automobiles
 - electric power steering
 - starter generator
- in industrial vehicles
 - propulsion drives
 - fork lift drives
- in battery supplied equipment

Features

- MOSFETs in trench technology:
 - low R_{DSon}
 - optimized intrinsic reverse diode
- package:
 - high level of integration
 - high current capability
 - aux. terminals for MOSFET control
 - terminals for soldering or welding connections
 - isolated DCB ceramic base plate with optimized heat transfer
- Space and weight savings

Symbol	Conditions	Characteristic Values				
		$(T_{VJ} = 25^{\circ}\text{C}, \text{ unless otherwise specified})$				
		min.	typ.	max.		
$R_{DSon}^{1)}$	on chip level at $V_{GS} = 10\text{ V}; I_D = 38\text{ A}$	$T_{VJ} = 25^{\circ}\text{C}$		19	24	$\text{m}\Omega$
		$T_{VJ} = 125^{\circ}\text{C}$		38		$\text{m}\Omega$
$V_{GS(th)}$	$V_{DS} = 20\text{ V}; I_D = 1\text{ mA}$	2.5		4.5	V	
I_{DSS}	$V_{DS} = V_{DSS}; V_{GS} = 0\text{ V}$		0.5	5	μA mA	
I_{GSS}	$V_{GS} = \pm 20\text{ V}; V_{DS} = 0\text{ V}$			0.2	μA	
Q_g	$V_{GS} = 10\text{ V}; V_{DS} = 75\text{ V}; I_D = 38\text{ A}$		97		nC	
Q_{gs}			29		nC	
Q_{gd}			30		nC	
C_{iss}	$V_{GS} = 10\text{ V}; V_{DS} = 25\text{ V}; f = 1\text{ MHz}$		5800		pF	
C_{oss}			490		pF	
C_{rss}			85		pF	
$t_{d(on)}$	inductive load $V_{GS} = 10\text{ V}; V_{DS} = 75\text{ V}$ $I_D = 38\text{ A}; R_{G(on)} = 39\ \Omega; R_{G(off)} = 4.7\ \Omega$ $T_J = 125^{\circ}\text{C}$		120		ns	
t_r			50		ns	
$t_{d(off)}$			100		ns	
t_f			25		ns	
E_{on}			0.25		mJ	
E_{off}			0.05		mJ	
E_{recoff}		0.02		mJ		
R_{thJC}			1.0		K/W	
R_{thJH}	with heat transfer paste (IXYS test setup)		1.3	1.6	K/W	

¹⁾ $V_{DS} = I_D \cdot (R_{DS(on)} + 2R_{Pin\ to\ Chip})$

Source-Drain Diode

Symbol	Conditions	Characteristic Values		
		min.	typ.	max.
($T_J = 25^\circ\text{C}$, unless otherwise specified)				
V_{SD}	(diode) $I_F = 38\text{ A}$; $V_{GS} = 0\text{ V}$	0.85	1.0	V
t_{rr}	$I_F = 38\text{ A}$; $-di_F/dt = 900\text{ A}/\mu\text{s}$; $R_{G(on)} = 39\ \Omega$; $V_R = 75\text{ V}$; $T_{VJ} = 125^\circ\text{C}$		65	ns
Q_{RM}			1.6	μC
I_{RM}			40	A

Component

Symbol	Conditions	Maximum Ratings	
I_{RMS}	per pin in main current paths (L+, L-, N-, L1, L2, L3) may be additionally limited by external connections 2 pins for output L1, L2, L3	75	A
T_J		-55...+175	$^\circ\text{C}$
T_{stg}		-55...+125	$^\circ\text{C}$
V_{ISOL}	$I_{ISOL} \leq 1\text{ mA}$, 50/60 Hz, $f = 1\text{ minute}$	1000	V~
F_c	mounting force with clip	50 - 250	N

Symbol	Conditions	Characteristic Values		
		min.	typ.	max.
$R_{pin\ to\ chip}^{1)}$	L+ to L1/L2/L3 or L- to L1/L2/L3		0.9	$\text{m}\Omega$
C_p	coupling capacity between shorted pins and back side metallization		160	pF
Weight			13	g

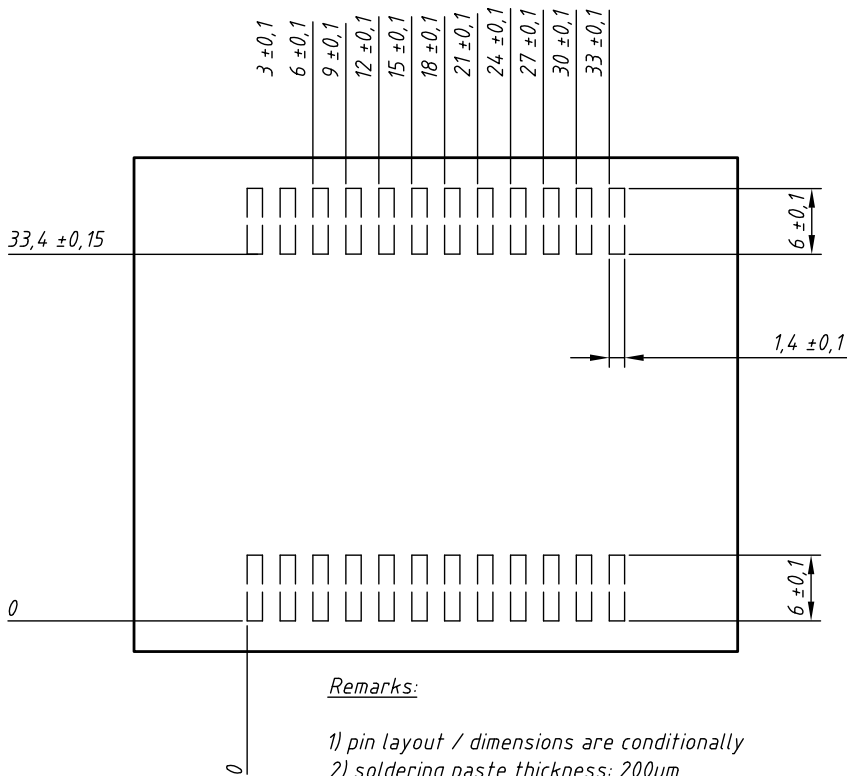
¹⁾ $V_{DS} = I_D \cdot (R_{DS(on)} + 2R_{Pin\ to\ Chip})$
Recommended printed circuit board lay-out

IXYS reserves the right to change limits, test conditions and dimensions.

20170529c

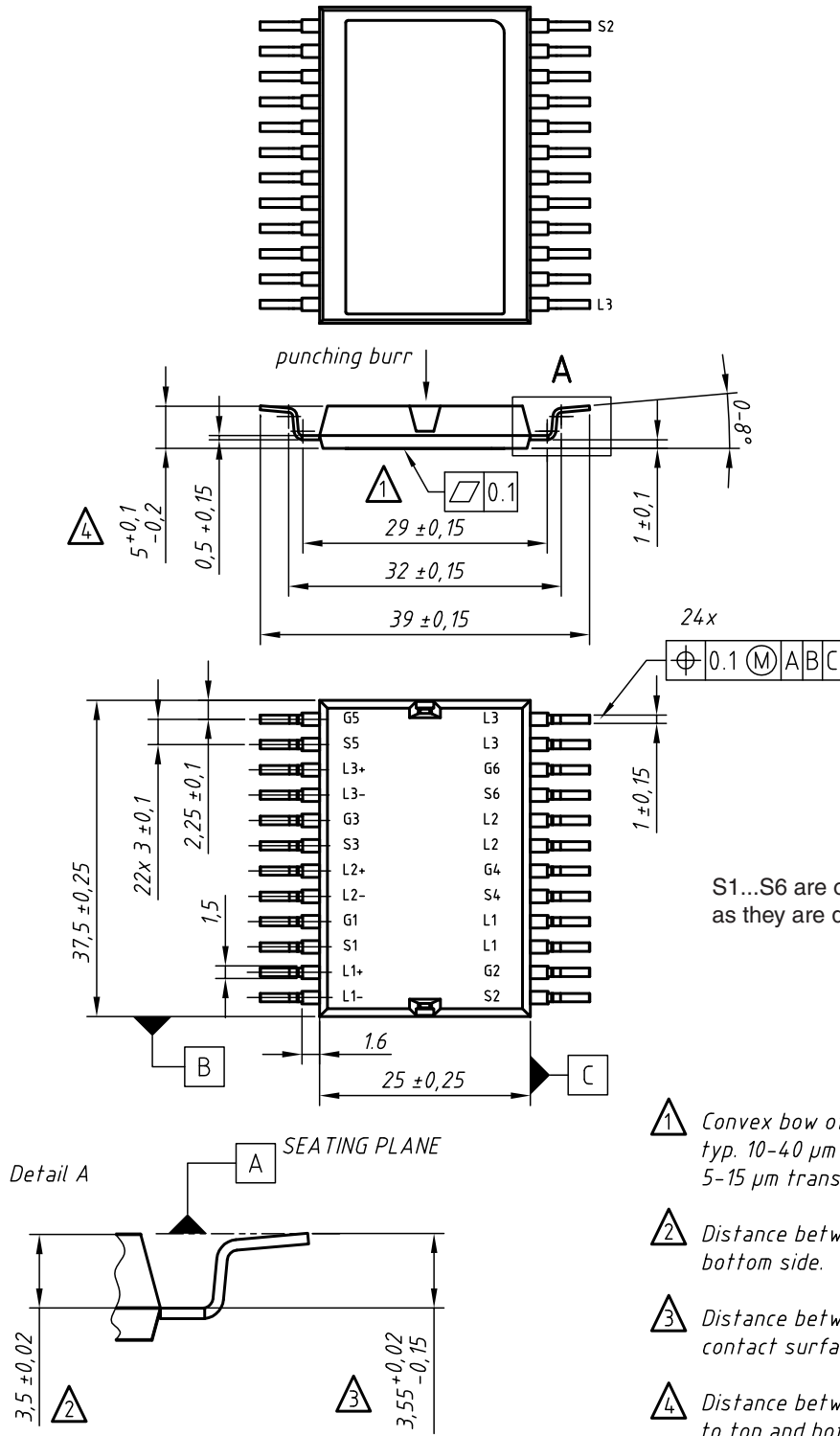

S1...S6 are only for the use of the gate drive as they are designed as Kelvin contacts

- $\triangle 1$ Convex bow of substrate, typ. 10-40 μm longitudinal and 5-15 μm transversal
- $\triangle 2$ Distance between pin and case bottom side.
- $\triangle 3$ Distance between pin and contact surface.
- $\triangle 4$ Distance between parallel planes aligned to top and bottom sides of the package

contact pin:

- galv. tin plating, per pin side: Sn 10...25 μm , undercoating Ni 0,2...1 μm
- stamping edges may be free of tin
- punching burr: $\leq 0,05\text{mm}$

Leads	Ordering	Part Name & Packing Unit Marking	Part Marking	Delivering Mode	Base Qty.	Ordering Code
SMD	Standard	GMM 3x60-015X2 - SMD	GMM 3x60-015X2	Tube	13	518037

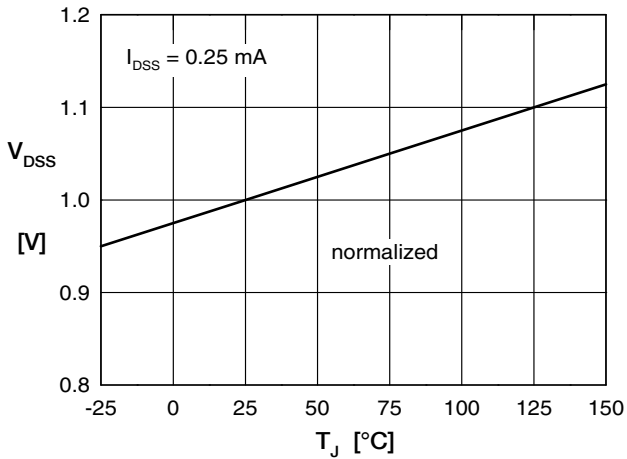

Fig. 1 Drain source breakdown voltage V_{DSS} vs. junction temperature T_{VJ}

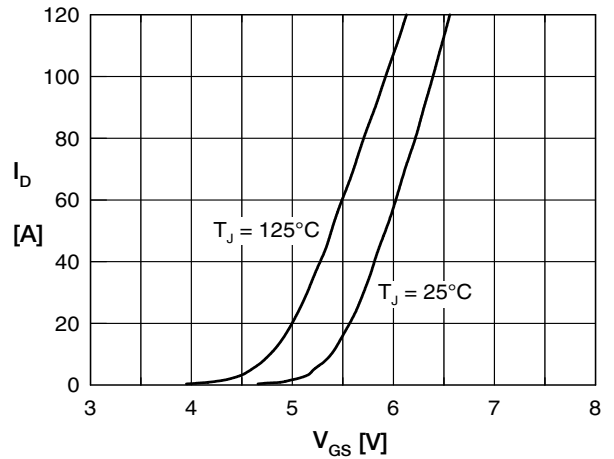

Fig. 2 Typ. transfer characteristics

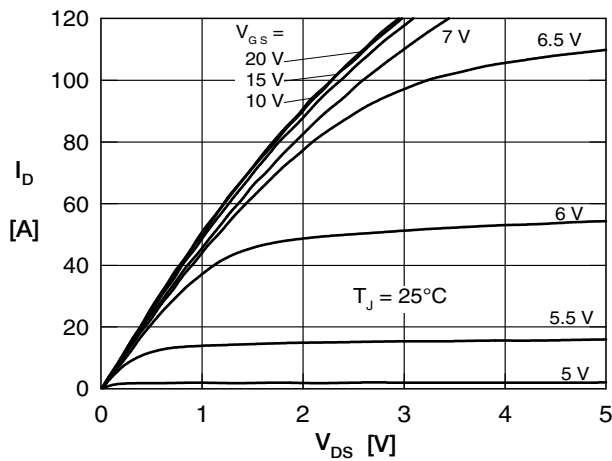

Fig. 3 Typ. output characteristics

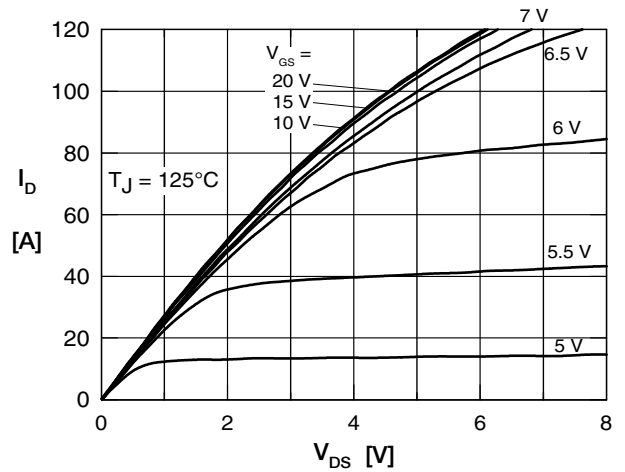

Fig. 4 Typ. output characteristics

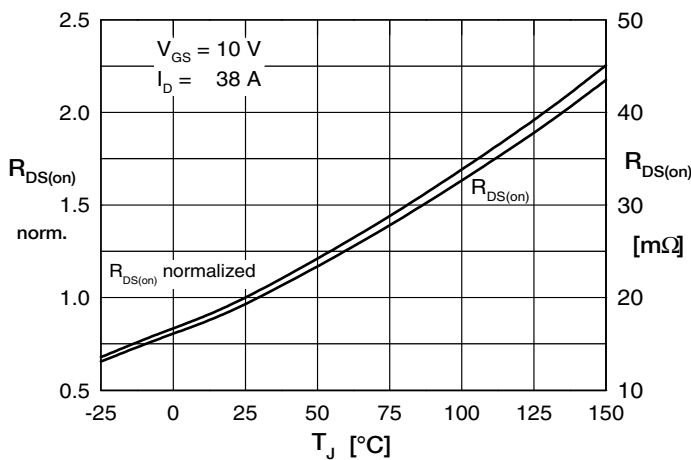

Fig. 5 Drain source on-state resistance $R_{DS(on)}$ versus junction temperature T_{VJ}

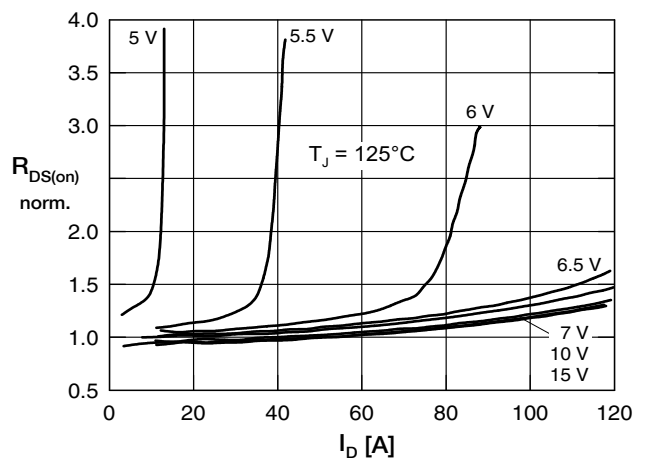

Fig. 6 Drain source on-state resistance $R_{DS(on)}$ versus I_D

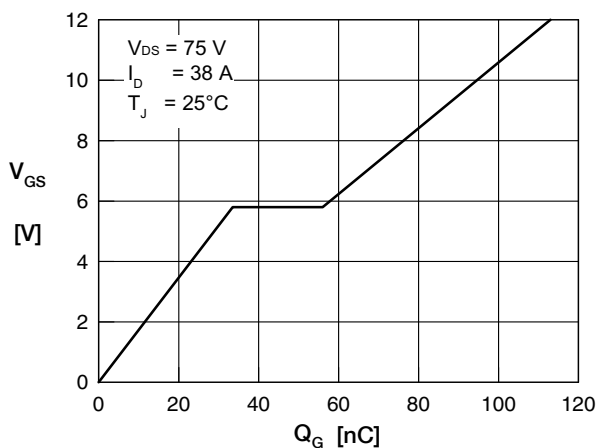

Fig. 7 Typical turn on gate charge

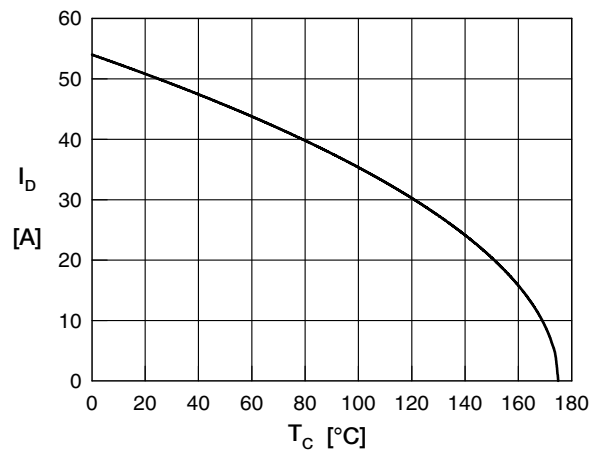
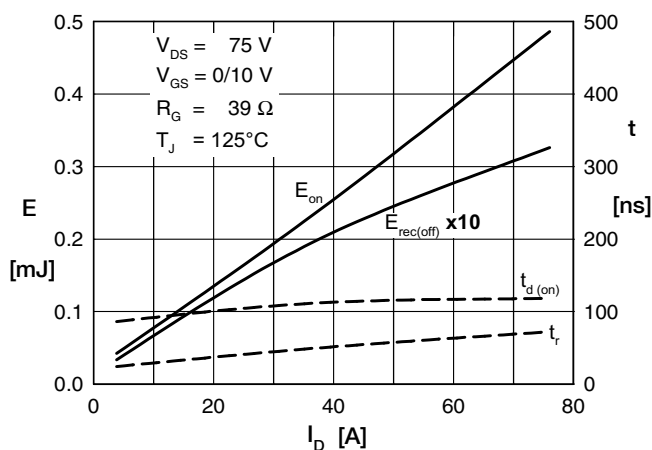

 Fig. 8 Drain current I_D vs. case temperature T_C

Fig. 9 Typ. turn-on energy and switching times versus drain current, inductive switching

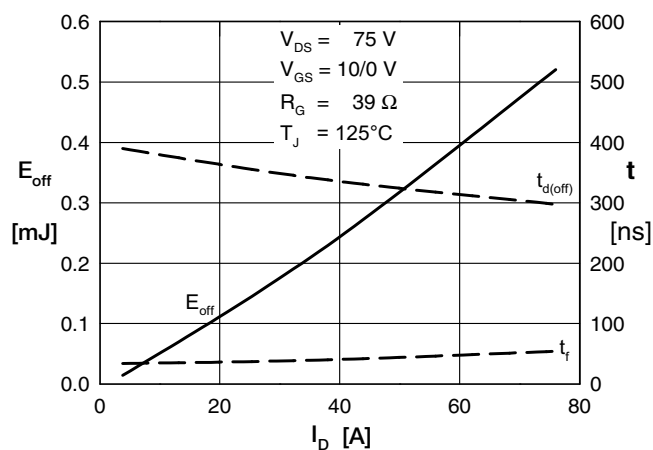

Fig. 10 Typ. turn-off energy and switching times versus drain-current, inductive switching

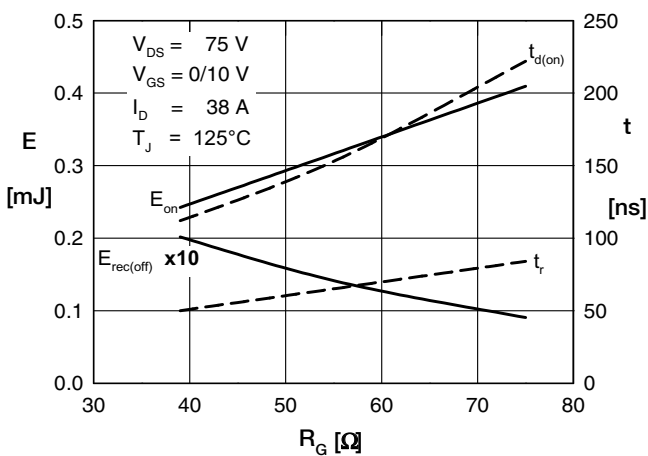

Fig. 11 Typ. turn-on energy and switching times versus gate resistor, inductive switching

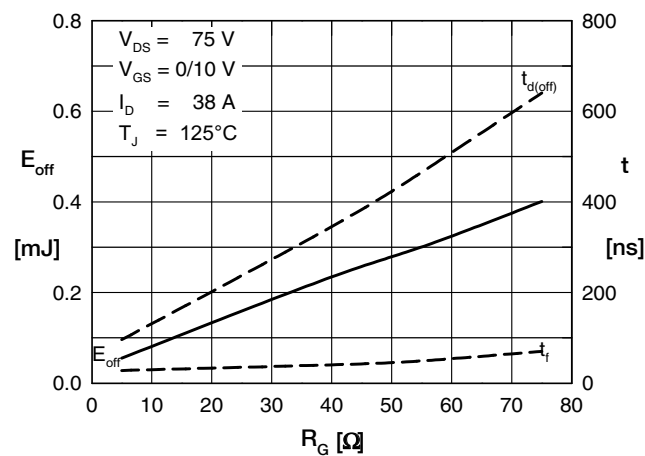

Fig. 12 Typ. turn-off energy and switching times versus gate resistor, inductive switching

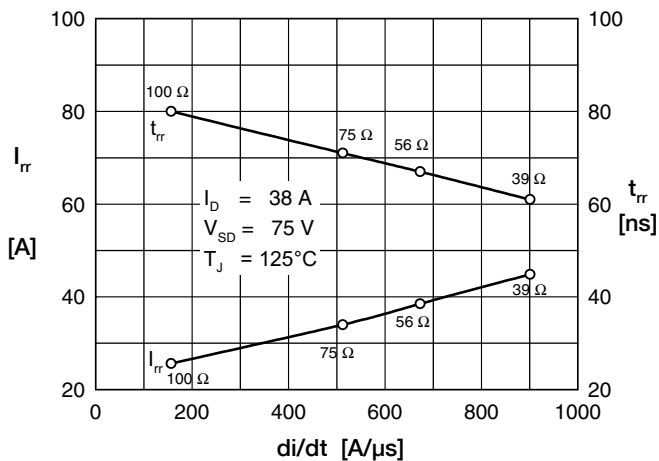

Fig. 13 Typ. reverse recovery characteristics

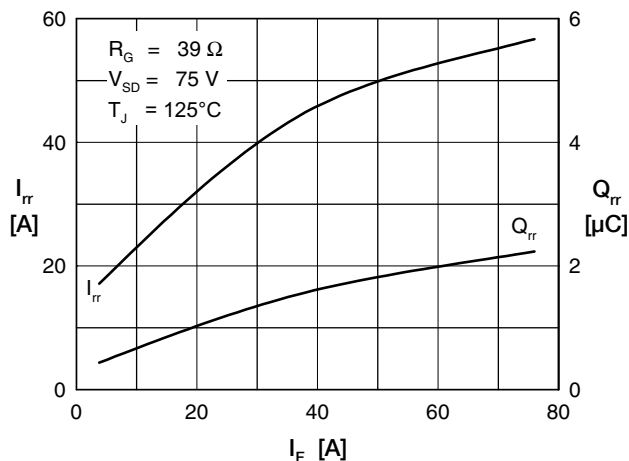

Fig. 14 Typ. reverse recovery characteristics

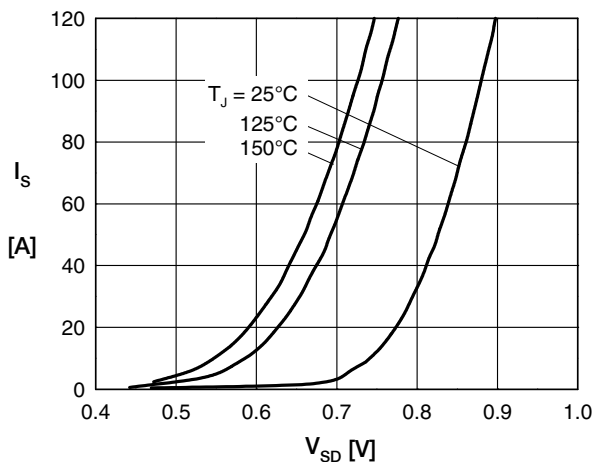

Fig. 15 Source current I_S versus source drain voltage V_{SD} (body diode)

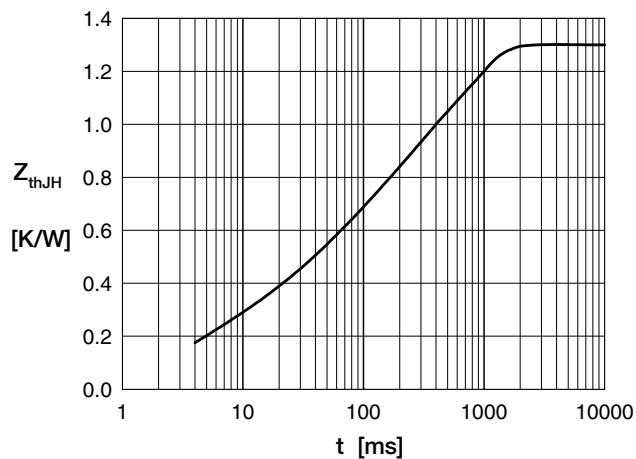

Fig. 16 Typ. thermal impedance junction to heatsink Z_{thJH} with heat transfer paste (IXYS test setup)

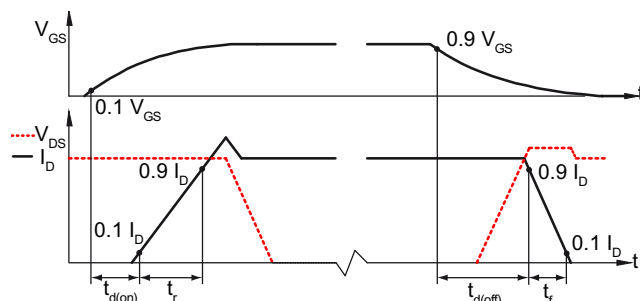

Fig. 17 Definition of switching times