



Thyristor \ Diode Module

$V_{RRM} = 2 \times 800 \text{ V}$

$I_{TAV} = 181 \text{ A}$

$V_T = 1.03 \text{ V}$

Phase leg

Part number

MCD162-08io1



Backside: isolated



Features / Advantages:

- Thyristor for line frequency
- Planar passivated chip
- Long-term stability
- Direct Copper Bonded Al2O3-ceramic

Applications:

- Line rectifying 50/60 Hz
- Softstart AC motor control
- DC Motor control
- Power converter
- AC power control
- Lighting and temperature control

Package: Y4

- Isolation Voltage: 3600 V~
- Industry standard outline
- RoHS compliant
- Soldering pins for PCB mounting
- Base plate: DCB ceramic
- Reduced weight
- Advanced power cycling

Disclaimer Notice

Information furnished is believed to be accurate and reliable. However, users should independently evaluate the suitability of and test each product selected for their own applications. Littelfuse products are not designed for, and may not be used in, all applications. Read complete Disclaimer Notice at www.littelfuse.com/disclaimer-electronics.



Rectifier				Ratings			
Symbol	Definition	Conditions	min.	typ.	max.	Unit	
$V_{RSM/DSM}$	max. non-repetitive reverse/forward blocking voltage	$T_{VJ} = 25^{\circ}C$			900	V	
$V_{RRM/DRM}$	max. repetitive reverse/forward blocking voltage	$T_{VJ} = 25^{\circ}C$			800	V	
I_{RD}	reverse current, drain current	$V_{R/D} = 800 V$	$T_{VJ} = 25^{\circ}C$		300	μA	
		$V_{R/D} = 800 V$	$T_{VJ} = 125^{\circ}C$		10	mA	
V_T	forward voltage drop	$I_T = 150 A$	$T_{VJ} = 25^{\circ}C$		1.09	V	
		$I_T = 300 A$			1.25	V	
		$I_T = 150 A$	$T_{VJ} = 125^{\circ}C$		1.03	V	
		$I_T = 300 A$			1.25	V	
I_{TAV}	average forward current	$T_C = 85^{\circ}C$	$T_{VJ} = 125^{\circ}C$		181	A	
$I_{T(RMS)}$	RMS forward current	180° sine			300	A	
V_{T0}	threshold voltage	} for power loss calculation only	$T_{VJ} = 125^{\circ}C$		0.88	V	
r_T	slope resistance				1.15	m Ω	
R_{thJC}	thermal resistance junction to case				0.155	K/W	
R_{thCH}	thermal resistance case to heatsink			0.07		K/W	
P_{tot}	total power dissipation		$T_C = 25^{\circ}C$		645	W	
I_{TSM}	max. forward surge current	$t = 10 \text{ ms}; (50 \text{ Hz}), \text{ sine}$	$T_{VJ} = 45^{\circ}C$		6.00	kA	
		$t = 8,3 \text{ ms}; (60 \text{ Hz}), \text{ sine}$	$V_R = 0 V$		6.48	kA	
		$t = 10 \text{ ms}; (50 \text{ Hz}), \text{ sine}$	$T_{VJ} = 125^{\circ}C$		5.10	kA	
		$t = 8,3 \text{ ms}; (60 \text{ Hz}), \text{ sine}$	$V_R = 0 V$		5.51	kA	
I^2t	value for fusing	$t = 10 \text{ ms}; (50 \text{ Hz}), \text{ sine}$	$T_{VJ} = 45^{\circ}C$		180.0	kA ² s	
		$t = 8,3 \text{ ms}; (60 \text{ Hz}), \text{ sine}$	$V_R = 0 V$		174.7	kA ² s	
		$t = 10 \text{ ms}; (50 \text{ Hz}), \text{ sine}$	$T_{VJ} = 125^{\circ}C$		130.1	kA ² s	
		$t = 8,3 \text{ ms}; (60 \text{ Hz}), \text{ sine}$	$V_R = 0 V$		126.3	kA ² s	
C_J	junction capacitance	$V_R = 400 V \quad f = 1 \text{ MHz}$	$T_{VJ} = 25^{\circ}C$		273	pF	
P_{GM}	max. gate power dissipation	$t_p = 30 \mu s$	$T_C = 125^{\circ}C$		120	W	
		$t_p = 500 \mu s$			60	W	
P_{GAV}	average gate power dissipation				8	W	
$(di/dt)_{cr}$	critical rate of rise of current	$T_{VJ} = 125^{\circ}C; f = 50 \text{ Hz}$	repetitive, $I_T = 540 A$		150	A/ μs	
		$t_p = 200 \mu s; di_G/dt = 0.5 A/\mu s;$	non-repet., $I_T = 180 A$		500	A/ μs	
$(dv/dt)_{cr}$	critical rate of rise of voltage	$V = \frac{2}{3} V_{DRM}$	$T_{VJ} = 125^{\circ}C$		1000	V/ μs	
		$R_{GK} = \infty; \text{method 1 (linear voltage rise)}$					
V_{GT}	gate trigger voltage	$V_D = 6 V$	$T_{VJ} = 25^{\circ}C$		2.5	V	
			$T_{VJ} = -40^{\circ}C$		2.6	V	
I_{GT}	gate trigger current	$V_D = 6 V$	$T_{VJ} = 25^{\circ}C$		150	mA	
			$T_{VJ} = -40^{\circ}C$		200	mA	
V_{GD}	gate non-trigger voltage	$V_D = \frac{2}{3} V_{DRM}$	$T_{VJ} = 125^{\circ}C$		0.2	V	
I_{GD}	gate non-trigger current				10	mA	
I_L	latching current	$t_p = 30 \mu s$	$T_{VJ} = 25^{\circ}C$		300	mA	
		$I_G = 0.5 A; di_G/dt = 0.5 A/\mu s$					
I_H	holding current	$V_D = 6 V \quad R_{GK} = \infty$	$T_{VJ} = 25^{\circ}C$		200	mA	
t_{gd}	gate controlled delay time	$V_D = \frac{1}{2} V_{DRM}$	$T_{VJ} = 25^{\circ}C$		2	μs	
		$I_G = 0.5 A; di_G/dt = 0.5 A/\mu s$					
t_q	turn-off time	$V_R = 100 V; I_T = 300 A; V = \frac{2}{3} V_{DRM}$	$T_{VJ} = 100^{\circ}C$		150	μs	
		$di/dt = 10 A/\mu s \quad dv/dt = 20 V/\mu s \quad t_p = 200 \mu s$					



Package Y4				Ratings			
Symbol	Definition	Conditions	min.	typ.	max.	Unit	
I_{RMS}	RMS current	per terminal			300	A	
T_{VJ}	virtual junction temperature		-40		125	°C	
T_{op}	operation temperature		-40		100	°C	
T_{stg}	storage temperature		-40		125	°C	
Weight					150	g	
M_D	mounting torque		2.25		2.75	Nm	
M_T	terminal torque		4.5		5.5	Nm	
$d_{Spp/App}$	creepage distance on surface striking distance through air	terminal to terminal	14.0	10.0		mm	
$d_{Spb/Apb}$		terminal to backside	16.0	16.0		mm	
V_{ISOL}	isolation voltage	t = 1 second			3600	V	
		t = 1 minute	50/60 Hz, RMS; $I_{ISOL} \leq 1$ mA		3000	V	



Data Matrix: part no. (1-19), DC + PI (20-25), lot.no.# (26-31), blank (32), serial no.# (33-36)

Ordering	Ordering Number	Marking on Product	Delivery Mode	Quantity	Code No.
Standard	MCD162-08io1	MCD162-08io1	Box	6	429635

Equivalent Circuits for Simulation

* on die level

$T_{VJ} = 125^{\circ}\text{C}$



Thyristor

$V_{0\ max}$	threshold voltage	0.88	V
$R_{0\ max}$	slope resistance *	0.8	mΩ



Outlines Y4

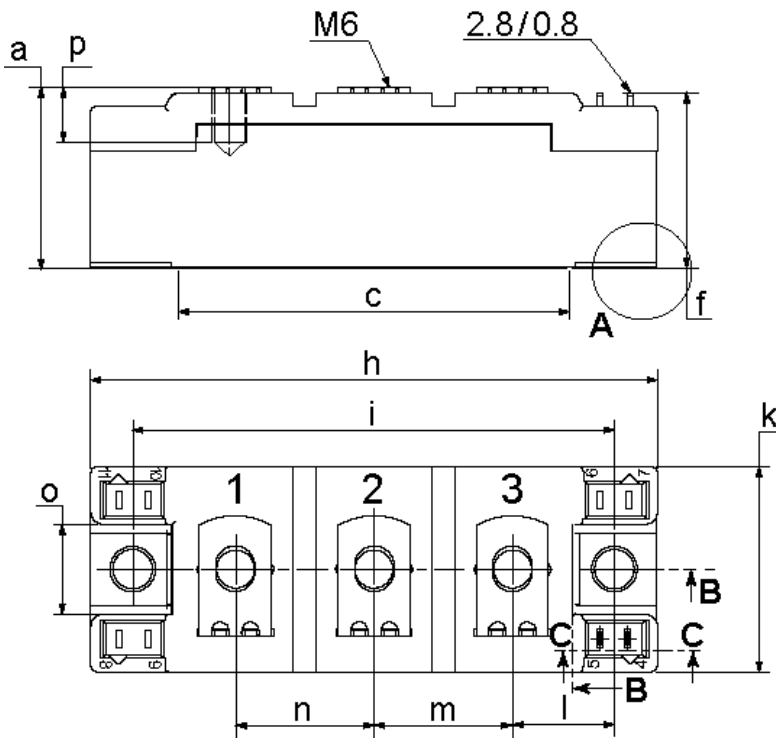

Dim.	MIN [mm]	MAX [mm]	MIN [inch]	MAX [inch]
a	30.0	30.6	1.181	1.205
b	typ. 0.25		typ. 0.010	
c	64.0	65.0	2.520	2.559
d	6.5	7.0	0.256	0.275
e	4.9	5.1	0.193	0.201
f	28.6	29.2	1.126	1.150
g	7.3	7.7	0.287	0.303
h	93.5	94.5	3.681	3.720
i	79.5	80.5	3.130	3.169
j	4.8	5.2	0.189	0.205
k	33.4	34.0	1.315	1.339
l	16.7	17.3	0.657	0.681
m	22.7	23.3	0.894	0.917
n	22.7	23.3	0.894	0.917
o	14.0	15.0	0.551	0.591
p	typ. 10.5		typ. 0.413	
r	1.8	2.4	0.071	0.041

Optional accessories for modules
Keyed gate/cathode twin plugs with wire length = 350 mm, gate = white, cathode = red
Type ZY 180L (L = Left for pin pair 4/5) UL 758, style 3751

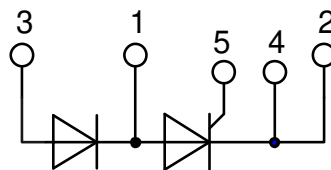

Thyristor

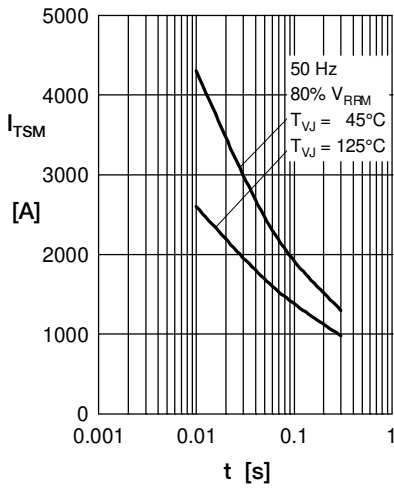

Fig. 1 Surge overload current I_{TSM} , I_{FSM} : Crest value, t: duration



Fig. 2 I^2dt versus time (1-10 ms)

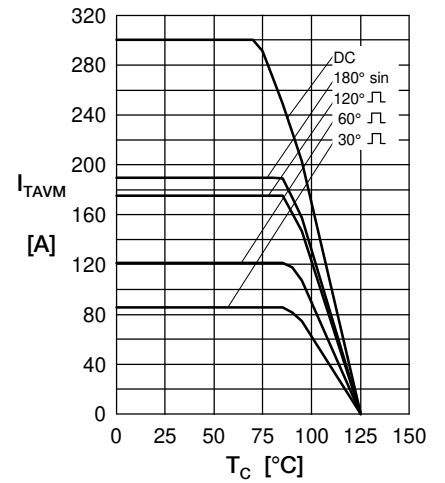

Fig. 3 Max. forward current at case temperature

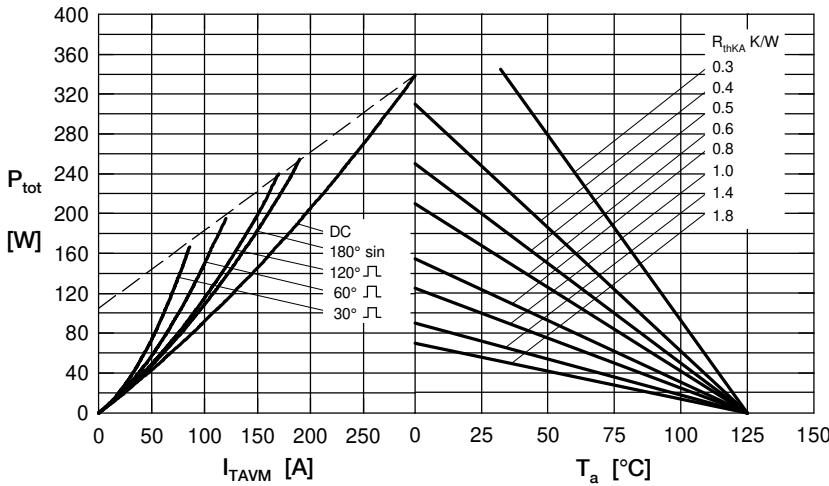

Fig. 4 Power dissipation vs. on-state current & ambient temperature (per thyristor or diode)



Fig. 5 Gate trigger characteristics

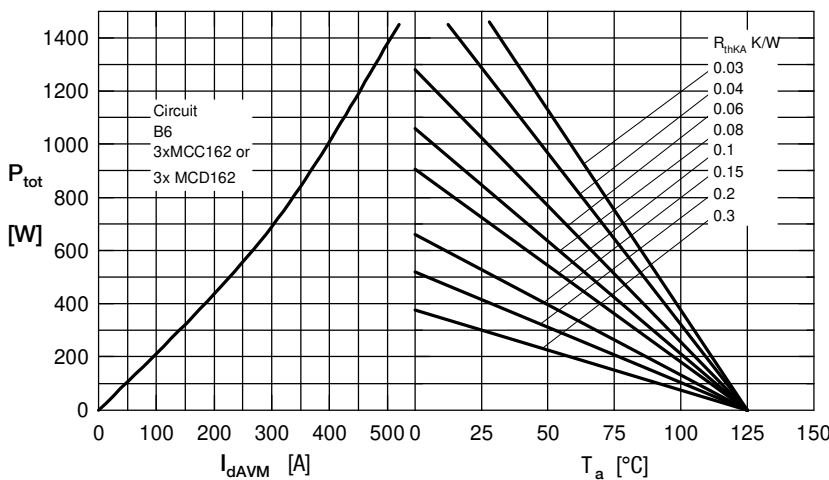

Fig. 6 Three phase rectifier bridge: Power dissipation versus direct output current and ambient temperature



Fig. 7 Gate trigger delay time



Rectifier

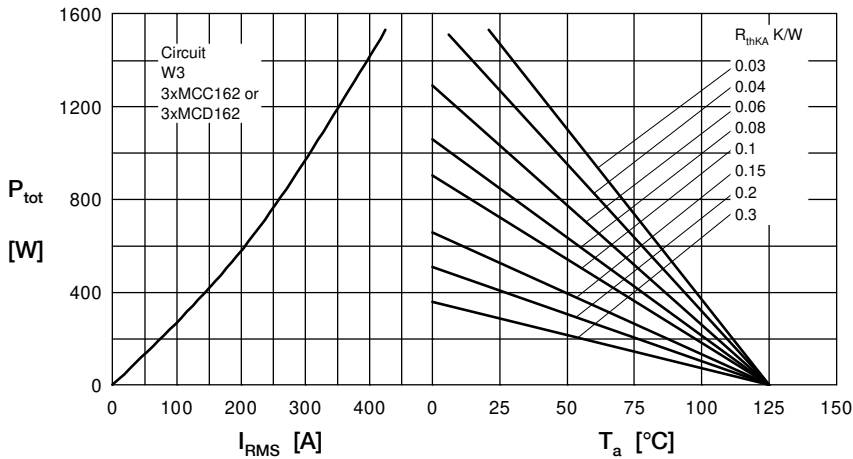
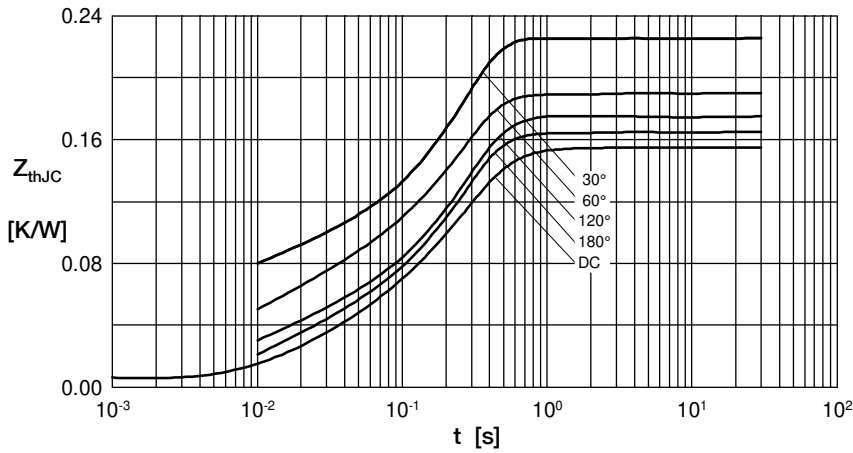

Fig. 8 Three phase AC-controller: Power dissipation versus RMS output current and ambient temperature



R_{thJC} for various conduction angles d:

d	R_{thJC} [K/W]
DC	0.155
180°	0.167
120°	0.176
60°	0.197
30°	0.227

Constants for Z_{thJC} calculation:

i	R_{thi} [K/W]	t_i [s]
1	0.0072	0.001
2	0.0188	0.080
3	0.1290	0.200

Fig. 9 Transient thermal impedance junction to case (per thyristor/diode)

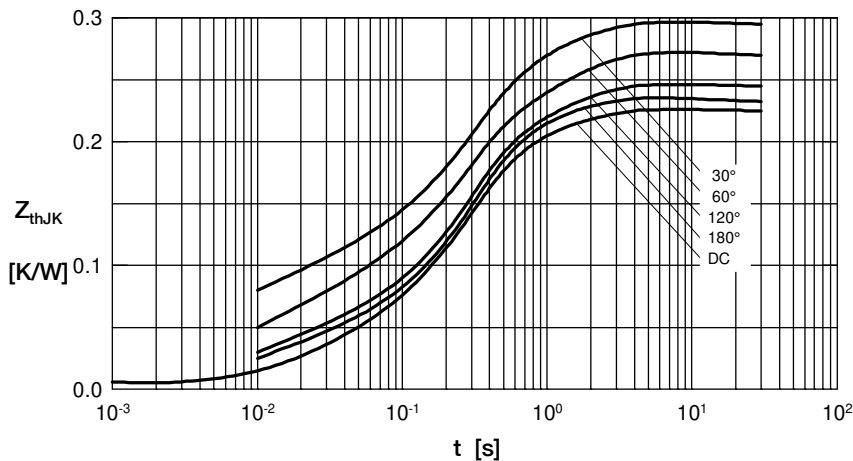

R_{thJK} for various conduction angles d:

d	R_{thJK} [K/W]
DC	0.225
180°	0.237
120°	0.246
60°	0.267
30°	0.297

Constants for Z_{thJK} calculation:

i	R_{thi} [K/W]	t_i [s]
1	0.0072	0.001
2	0.0188	0.080
3	0.1290	0.200
4	0.0700	1.000

Fig. 10 Transient thermal impedance junction to heatsink (per thyristor/diode)