



Thyristor \ Diode Module

$V_{RRM} = 2 \times 1600 \text{ V}$

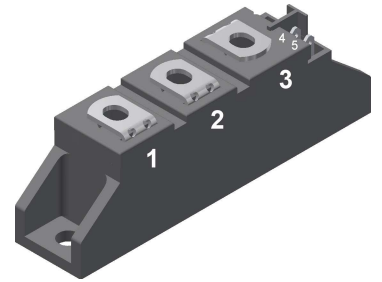
$I_{TAV} = 116 \text{ A}$

$V_T = 1.28 \text{ V}$

Phase leg

Part number

MCD95-16io1



Backside: isolated



Features / Advantages:

- Thyristor for line frequency
- Planar passivated chip
- Long-term stability
- Direct Copper Bonded Al₂O₃-ceramic

Applications:

- Line rectifying 50/60 Hz
- Softstart AC motor control
- DC Motor control
- Power converter
- AC power control
- Lighting and temperature control

Package: TO-240AA

- Isolation Voltage: 4800 V~
- Industry standard outline
- RoHS compliant
- Soldering pins for PCB mounting
- Base plate: DCB ceramic
- Reduced weight
- Advanced power cycling

Disclaimer Notice

Information furnished is believed to be accurate and reliable. However, users should independently evaluate the suitability of and test each product selected for their own applications. Littelfuse products are not designed for, and may not be used in, all applications. Read complete Disclaimer Notice at www.littelfuse.com/disclaimer-electronics.



| Rectifier | | | | Ratings | | | |
|----------------|--|--|-------------------------|---------|------|-------------------|--|
| Symbol | Definition | Conditions | min. | typ. | max. | Unit | |
| $V_{RSM/DSM}$ | max. non-repetitive reverse/forward blocking voltage | $T_{VJ} = 25^{\circ}C$ | | | 1700 | V | |
| $V_{RRM/DRM}$ | max. repetitive reverse/forward blocking voltage | $T_{VJ} = 25^{\circ}C$ | | | 1600 | V | |
| I_{RD} | reverse current, drain current | $V_{R/D} = 1600 V$ | $T_{VJ} = 25^{\circ}C$ | | 200 | μA | |
| | | $V_{R/D} = 1600 V$ | $T_{VJ} = 125^{\circ}C$ | | 5 | mA | |
| V_T | forward voltage drop | $I_T = 150 A$ | $T_{VJ} = 25^{\circ}C$ | | 1.29 | V | |
| | | $I_T = 300 A$ | | | 1.50 | V | |
| | | $I_T = 150 A$ | $T_{VJ} = 125^{\circ}C$ | | 1.28 | V | |
| | | $I_T = 300 A$ | | | 1.70 | V | |
| I_{TAV} | average forward current | $T_C = 85^{\circ}C$ | $T_{VJ} = 125^{\circ}C$ | | 116 | A | |
| $I_{T(RMS)}$ | RMS forward current | 180° sine | | | 182 | A | |
| V_{T0} | threshold voltage | } for power loss calculation only | $T_{VJ} = 125^{\circ}C$ | | 0.85 | V | |
| r_T | slope resistance | | | | 2.4 | m Ω | |
| R_{thJC} | thermal resistance junction to case | | | | 0.22 | K/W | |
| R_{thCH} | thermal resistance case to heatsink | | | 0.2 | | K/W | |
| P_{tot} | total power dissipation | | $T_C = 25^{\circ}C$ | | 455 | W | |
| I_{TSM} | max. forward surge current | $t = 10 ms$; (50 Hz), sine | $T_{VJ} = 45^{\circ}C$ | | 2.25 | kA | |
| | | $t = 8,3 ms$; (60 Hz), sine | $V_R = 0 V$ | | 2.43 | kA | |
| | | $t = 10 ms$; (50 Hz), sine | $T_{VJ} = 125^{\circ}C$ | | 1.92 | kA | |
| | | $t = 8,3 ms$; (60 Hz), sine | $V_R = 0 V$ | | 2.07 | kA | |
| I^2t | value for fusing | $t = 10 ms$; (50 Hz), sine | $T_{VJ} = 45^{\circ}C$ | | 25.3 | kA ² s | |
| | | $t = 8,3 ms$; (60 Hz), sine | $V_R = 0 V$ | | 24.6 | kA ² s | |
| | | $t = 10 ms$; (50 Hz), sine | $T_{VJ} = 125^{\circ}C$ | | 18.3 | kA ² s | |
| | | $t = 8,3 ms$; (60 Hz), sine | $V_R = 0 V$ | | 17.7 | kA ² s | |
| C_J | junction capacitance | $V_R = 400 V$ $f = 1 MHz$ | $T_{VJ} = 25^{\circ}C$ | | 119 | pF | |
| P_{GM} | max. gate power dissipation | $t_p = 30 \mu s$ | $T_C = 125^{\circ}C$ | | 10 | W | |
| | | $t_p = 300 \mu s$ | | | 5 | W | |
| P_{GAV} | average gate power dissipation | | | | 0.5 | W | |
| $(di/dt)_{cr}$ | critical rate of rise of current | $T_{VJ} = 125^{\circ}C$; $f = 50 Hz$ repetitive, $I_T = 250 A$ | | | 150 | A/ μs | |
| | | $t_p = 200 \mu s$; $di_G/dt = 0.45 A/\mu s$; $I_G = 0.45 A$; $V = \frac{2}{3} V_{DRM}$ non-repet., $I_T = 116 A$ | | | 500 | A/ μs | |
| $(dv/dt)_{cr}$ | critical rate of rise of voltage | $V = \frac{2}{3} V_{DRM}$ $R_{GK} = \infty$; method 1 (linear voltage rise) | $T_{VJ} = 125^{\circ}C$ | | 1000 | V/ μs | |
| V_{GT} | gate trigger voltage | $V_D = 6 V$ | $T_{VJ} = 25^{\circ}C$ | | 2.5 | V | |
| | | | $T_{VJ} = -40^{\circ}C$ | | 2.6 | V | |
| I_{GT} | gate trigger current | $V_D = 6 V$ | $T_{VJ} = 25^{\circ}C$ | | 150 | mA | |
| | | | $T_{VJ} = -40^{\circ}C$ | | 200 | mA | |
| V_{GD} | gate non-trigger voltage | $V_D = \frac{2}{3} V_{DRM}$ | $T_{VJ} = 125^{\circ}C$ | | 0.2 | V | |
| I_{GD} | gate non-trigger current | | | | 10 | mA | |
| I_L | latching current | $t_p = 10 \mu s$ | $T_{VJ} = 25^{\circ}C$ | | 450 | mA | |
| | | $I_G = 0.45 A$; $di_G/dt = 0.45 A/\mu s$ | | | | | |
| I_H | holding current | $V_D = 6 V$ $R_{GK} = \infty$ | $T_{VJ} = 25^{\circ}C$ | | 200 | mA | |
| t_{gd} | gate controlled delay time | $V_D = \frac{1}{2} V_{DRM}$ | $T_{VJ} = 25^{\circ}C$ | | 2 | μs | |
| | | $I_G = 0.45 A$; $di_G/dt = 0.45 A/\mu s$ | | | | | |
| t_q | turn-off time | $V_R = 100 V$; $I_T = 150 A$; $V = \frac{2}{3} V_{DRM}$ $di/dt = 10 A/\mu s$ $dv/dt = 20 V/\mu s$ $t_p = 200 \mu s$ | $T_{VJ} = 100^{\circ}C$ | | 185 | μs | |



| Package TO-240AA | | | | Ratings | | | |
|------------------|--|----------------------|-------------------------------------|---------|------|------|--|
| Symbol | Definition | Conditions | min. | typ. | max. | Unit | |
| I_{RMS} | RMS current | per terminal | | | 200 | A | |
| T_{VJ} | virtual junction temperature | | -40 | | 125 | °C | |
| T_{op} | operation temperature | | -40 | | 100 | °C | |
| T_{stg} | storage temperature | | -40 | | 125 | °C | |
| Weight | | | | | 81 | g | |
| M_D | mounting torque | | 2.5 | | 4 | Nm | |
| M_T | terminal torque | | 2.5 | | 4 | Nm | |
| $d_{Spp/App}$ | creepage distance on surface striking distance through air | terminal to terminal | 13.0 | 9.7 | | mm | |
| $d_{Spb/Apb}$ | | terminal to backside | 16.0 | 16.0 | | mm | |
| V_{ISOL} | isolation voltage | t = 1 second | | 4800 | | V | |
| | | t = 1 minute | 50/60 Hz, RMS; $I_{ISOL} \leq 1$ mA | 4000 | | V | |



| Ordering | Ordering Number | Marking on Product | Delivery Mode | Quantity | Code No. |
|----------|-----------------|--------------------|---------------|----------|----------|
| Standard | MCD95-16IO1 | MCD95-16IO1 | Box | 36 | 464872 |

Equivalent Circuits for Simulation

* on die level

$T_{VJ} = 125^{\circ}\text{C}$

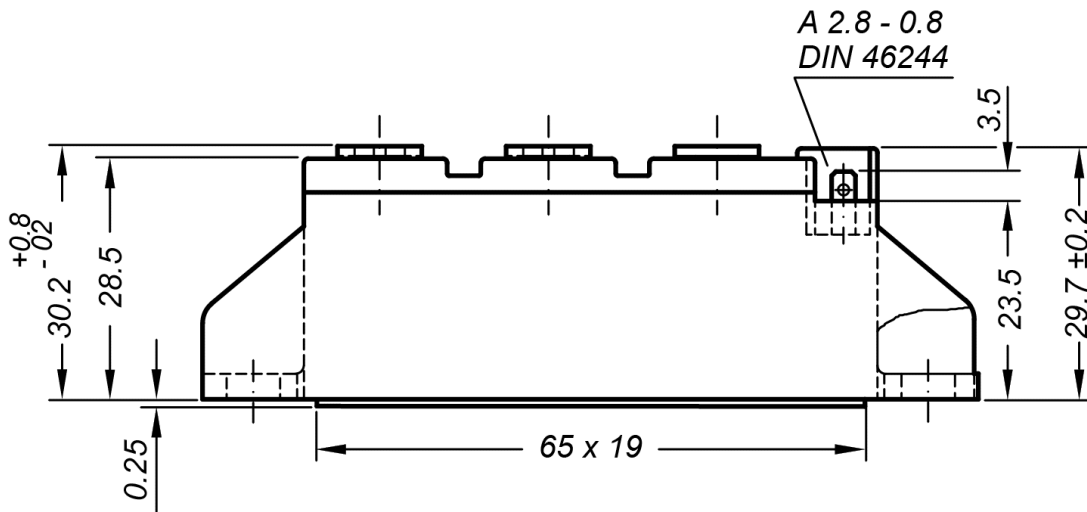


Thyristor

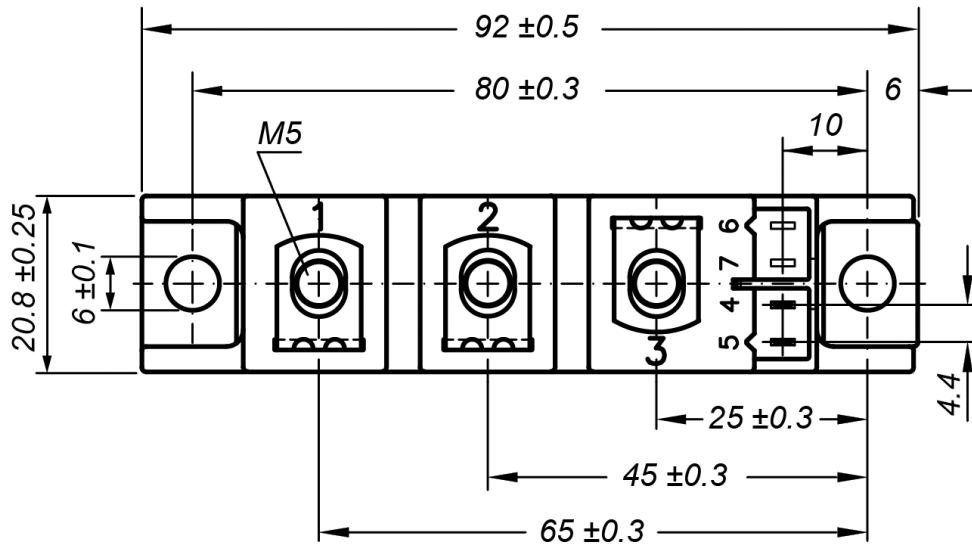
| | | | |
|--------------|--------------------|------|----|
| $V_{0\ max}$ | threshold voltage | 0.85 | V |
| $R_{0\ max}$ | slope resistance * | 1.2 | mΩ |



Outlines TO-240AA



General tolerance: DIN ISO 2768 class „c“



Optional accessories for modules

Keyed gate/cathode twin plugs with wire length = 350 mm, gate = white, cathode = red
Type ZY 200L (L = Left for pin pair 4/5) UL 758, style 3751



Thyristor



Fig. 1 Surge overload current I_{TSM} ,
 I_{FSM} : Crest value, t: duration



Fig. 2 I^2t versus time (1-10 ms)



Fig. 3 Max. forward current at case temperature



Fig. 4 Power dissipation vs. on-state current & ambient temperature (per thyristor or diode)

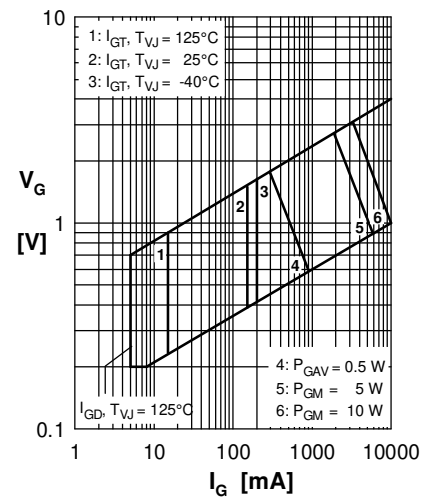


Fig. 5 Gate trigger characteristics



Fig. 6 Three phase rectifier bridge: Power dissipation vs. direct output current and ambient temperature

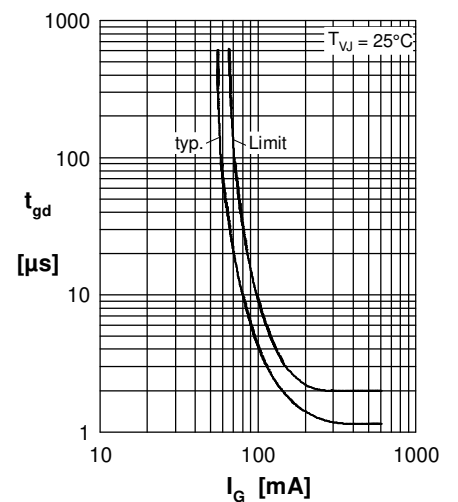


Fig. 7 Gate controlled delay time

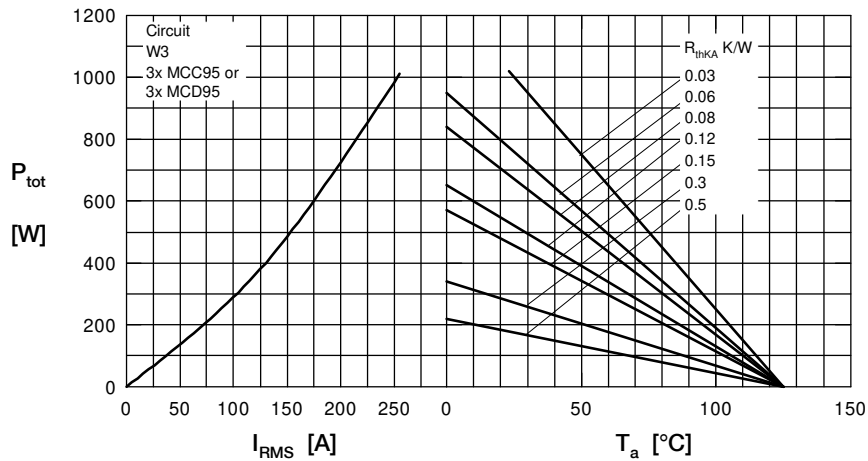
Rectifier


Fig. 8 Three phase AC-controller: Power dissipation versus RMS output current and ambient temperature

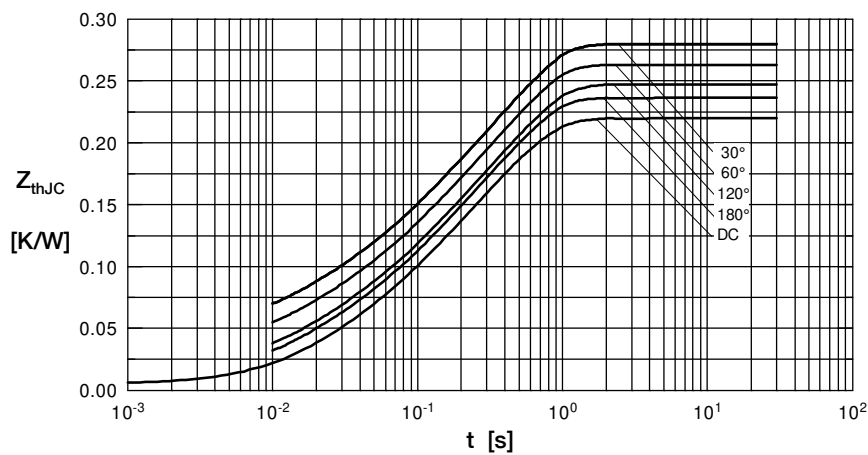


Fig. 9 Transient thermal impedance junction to case (per thyristor/diode)

R_{thJC} for various conduction angles d:

| d | R_{thJC} [K/W] |
|------|------------------|
| DC | 0.22 |
| 180° | 0.23 |
| 120° | 0.25 |
| 60° | 0.27 |
| 30° | 0.28 |

Constants for Z_{thJC} calculation:

| i | R_{thi} [K/W] | t_i [s] |
|---|-----------------|-----------|
| 1 | 0.0066 | 0.0019 |
| 2 | 0.0678 | 0.0477 |
| 3 | 0.1456 | 0.3440 |

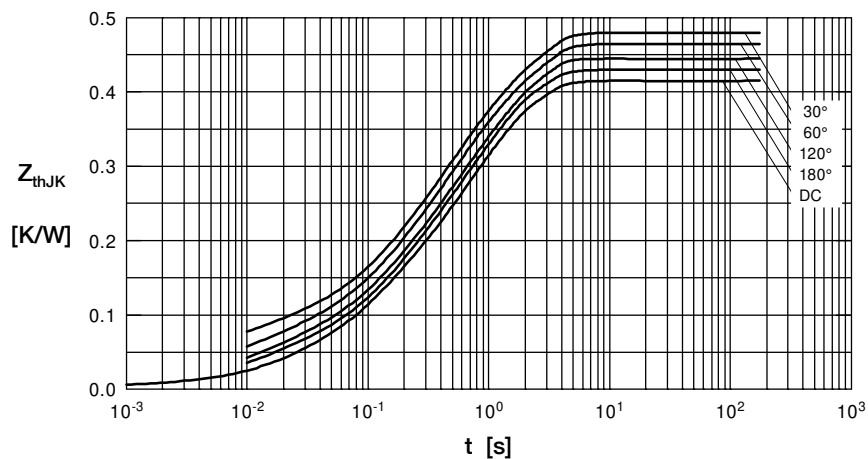


Fig. 10 Transient thermal impedance junction to heatsink (per thyristor/diode)

R_{thJK} for various conduction angles d:

| d | R_{thJK} [K/W] |
|------|------------------|
| DC | 0.42 |
| 180° | 0.43 |
| 120° | 0.45 |
| 60° | 0.47 |
| 30° | 0.48 |

Constants for Z_{thJK} calculation:

| i | R_{thi} [K/W] | t_i [s] |
|---|-----------------|-----------|
| 1 | 0.0066 | 0.0019 |
| 2 | 0.0678 | 0.0477 |
| 3 | 0.1456 | 0.3440 |
| 4 | 0.2000 | 1.3200 |