

# Thyristor Module

$$V_{RRM} = 1600 \text{ V}$$

$$I_{TAV} = 150 \text{ A}$$

$$V_T = 1.35 \text{ V}$$

AC Controlling  
 2~ full-controlled

Part number

**MCMA300MC1600PSF**

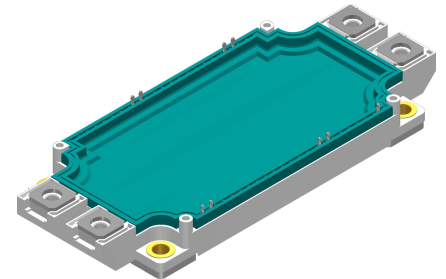

Backside: isolated

 E72873

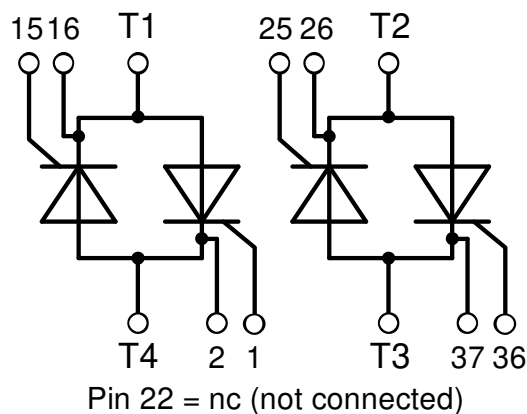

### Features / Advantages:

- Thyristor for line frequency
- Planar passivated chip
- Long-term stability
- Direct Copper Bonded Al<sub>2</sub>O<sub>3</sub>-ceramic

### Applications:

- Line rectifying 50/60 Hz
- Softstart AC motor control
- DC Motor control
- Power converter
- AC power control
- Lighting and temperature control

### Package: SimBus F

- Isolation Voltage: 4300 V~
- Industry standard outline
- RoHS compliant
- PressFit-Pins for PCB mounting
- Height: 17 mm
- Base plate: Copper internally DCB isolated
- Advanced power cycling
- Phase Change Material available

### Disclaimer Notice

Information furnished is believed to be accurate and reliable. However, users should independently evaluate the suitability of and test each product selected for their own applications. Littelfuse products are not designed for, and may not be used in, all applications. Read complete Disclaimer Notice at [www.littelfuse.com/disclaimer-electronics](http://www.littelfuse.com/disclaimer-electronics).



Thyristor				Ratings			
Symbol	Definition	Conditions		min.	typ.	max.	Unit
$V_{RSM/DSM}$	max. non-repetitive reverse/forward blocking voltage			$T_{VJ} = 25^{\circ}C$		1700	V
$V_{RRM/DRM}$	max. repetitive reverse/forward blocking voltage			$T_{VJ} = 25^{\circ}C$		1600	V
$I_{RD}$	reverse current, drain current	$V_{R/D} = 1600 V$		$T_{VJ} = 25^{\circ}C$		300	$\mu A$
		$V_{R/D} = 1600 V$		$T_{VJ} = 150^{\circ}C$		20	mA
$V_T$	forward voltage drop	$I_T = 150 A$		$T_{VJ} = 25^{\circ}C$		1.40	V
		$I_T = 300 A$				1.77	V
		$I_T = 150 A$		$T_{VJ} = 125^{\circ}C$		1.35	V
		$I_T = 300 A$				1.79	V
$I_{TAV}$	average forward current	$T_C = 100^{\circ}C$		$T_{VJ} = 150^{\circ}C$		150	A
$I_{RMS}$	RMS forward current per phase	sine 180°	d = 0.5			330	A
$V_{T0}$	threshold voltage	} for power loss calculation only		$T_{VJ} = 150^{\circ}C$		0.90	V
$r_T$	slope resistance					2.92	m $\Omega$
$R_{thJC}$	thermal resistance junction to case					0.17	K/W
$R_{thCH}$	thermal resistance case to heatsink				0.08		K/W
$P_{tot}$	total power dissipation			$T_C = 25^{\circ}C$		735	W
$I_{TSM}$	max. forward surge current	t = 10 ms; (50 Hz), sine		$T_{VJ} = 45^{\circ}C$		2.40	kA
		t = 8,3 ms; (60 Hz), sine		$V_R = 0 V$		2.59	kA
		t = 10 ms; (50 Hz), sine		$T_{VJ} = 150^{\circ}C$		2.04	kA
		t = 8,3 ms; (60 Hz), sine		$V_R = 0 V$		2.21	kA
$I^2t$	value for fusing	t = 10 ms; (50 Hz), sine		$T_{VJ} = 45^{\circ}C$		28.8	kA <sup>2</sup> s
		t = 8,3 ms; (60 Hz), sine		$V_R = 0 V$		27.9	kA <sup>2</sup> s
		t = 10 ms; (50 Hz), sine		$T_{VJ} = 150^{\circ}C$		20.8	kA <sup>2</sup> s
		t = 8,3 ms; (60 Hz), sine		$V_R = 0 V$		20.2	kA <sup>2</sup> s
$C_J$	junction capacitance	$V_R = 400 V$ f = 1 MHz		$T_{VJ} = 25^{\circ}C$	118		pF
$P_{GM}$	max. gate power dissipation	$t_p = 30 \mu s$		$T_C = 150^{\circ}C$		10	W
		$t_p = 300 \mu s$				5	W
$P_{GAV}$	average gate power dissipation					0.5	W
$(di/dt)_{cr}$	critical rate of rise of current	$T_{VJ} = 150^{\circ}C$ ; f = 50 Hz		repetitive, $I_T = 450 A$		150	A/ $\mu s$
		$t_p = 200 \mu s$ ; $di_G/dt = 0.45 A/\mu s$ ; $I_G = 0.45 A$ ; $V = \frac{2}{3} V_{DRM}$		non-repet., $I_T = 150 A$		500	A/ $\mu s$
$(dv/dt)_{cr}$	critical rate of rise of voltage	$V = \frac{2}{3} V_{DRM}$		$T_{VJ} = 150^{\circ}C$		1000	V/ $\mu s$
		$R_{GK} = \infty$ ; method 1 (linear voltage rise)					
$V_{GT}$	gate trigger voltage	$V_D = 6 V$		$T_{VJ} = 25^{\circ}C$		1.5	V
				$T_{VJ} = -40^{\circ}C$		1.6	V
$I_{GT}$	gate trigger current	$V_D = 6 V$		$T_{VJ} = 25^{\circ}C$		150	mA
				$T_{VJ} = -40^{\circ}C$		200	mA
$V_{GD}$	gate non-trigger voltage	$V_D = \frac{2}{3} V_{DRM}$		$T_{VJ} = 150^{\circ}C$		0.2	V
$I_{GD}$	gate non-trigger current					10	mA
$I_L$	latching current	$t_p = 30 \mu s$		$T_{VJ} = 25^{\circ}C$		200	mA
		$I_G = 0.45 A$ ; $di_G/dt = 0.45 A/\mu s$					
$I_H$	holding current	$V_D = 6 V$ $R_{GK} = \infty$		$T_{VJ} = 25^{\circ}C$		200	mA
$t_{gd}$	gate controlled delay time	$V_D = \frac{1}{2} V_{DRM}$		$T_{VJ} = 25^{\circ}C$		2	$\mu s$
		$I_G = 0.45 A$ ; $di_G/dt = 0.45 A/\mu s$					
$t_q$	turn-off time	$V_R = 100 V$ ; $I_T = 150 A$ ; $V = \frac{2}{3} V_{DRM}$		$T_{VJ} = 125^{\circ}C$	350		$\mu s$
		$di/dt = 10 A/\mu s$ $dv/dt = 20 V/\mu s$ $t_p = 200 \mu s$					

Package SimBus F		Ratings				
Symbol	Definition	Conditions	min.	typ.	max.	Unit
$I_{RMS}$	RMS current	per terminal			300	A
$T_{VJ}$	virtual junction temperature		-40		150	°C
$T_{op}$	operation temperature		-40		125	°C
$T_{stg}$	storage temperature		-40		125	°C
<b>Weight</b>				350		g
$M_D$	mounting torque		3		6	Nm
$M_T$	terminal torque		3		6	Nm
$d_{Spp/App}$	creepage distance on surface   striking distance through air	terminal to terminal	13.3	10.0		mm
$d_{Spb/Apb}$		terminal to backside	10.2	10.2		mm
$V_{ISOL}$	isolation voltage	t = 1 second		4300		V
		t = 1 minute	50/60 Hz, RMS; $I_{ISOL} \leq 1$ mA	3600		V

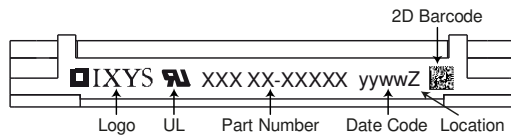

### Part description

M = Module  
 C = Thyristor (SCR)  
 M = Thyristor  
 A = (up to 1800V)  
 300 = Current Rating [A]  
 MC = 2~ full-controlled  
 1600 = Reverse Voltage [V]  
 P = PressFit-Pin  
 SF = SimBus F

Ordering	Ordering Number	Marking on Product	Delivery Mode	Quantity	Code No.
Standard	MCMA300MC1600PSF	MCMA300MC1600PSF	Blister	24	525675
Alternative	MCMA300MC1600PSF-PC	MCMA300MC1600PSF	Blister	24	

### Equivalent Circuits for Simulation

\* on die level

$T_{VJ} = 150^{\circ}\text{C}$

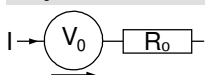

Thyristor

$V_{0\ max}$	threshold voltage	0.9	V
$R_{0\ max}$	slope resistance *	1.48	mΩ



**Outlines SimBus F**

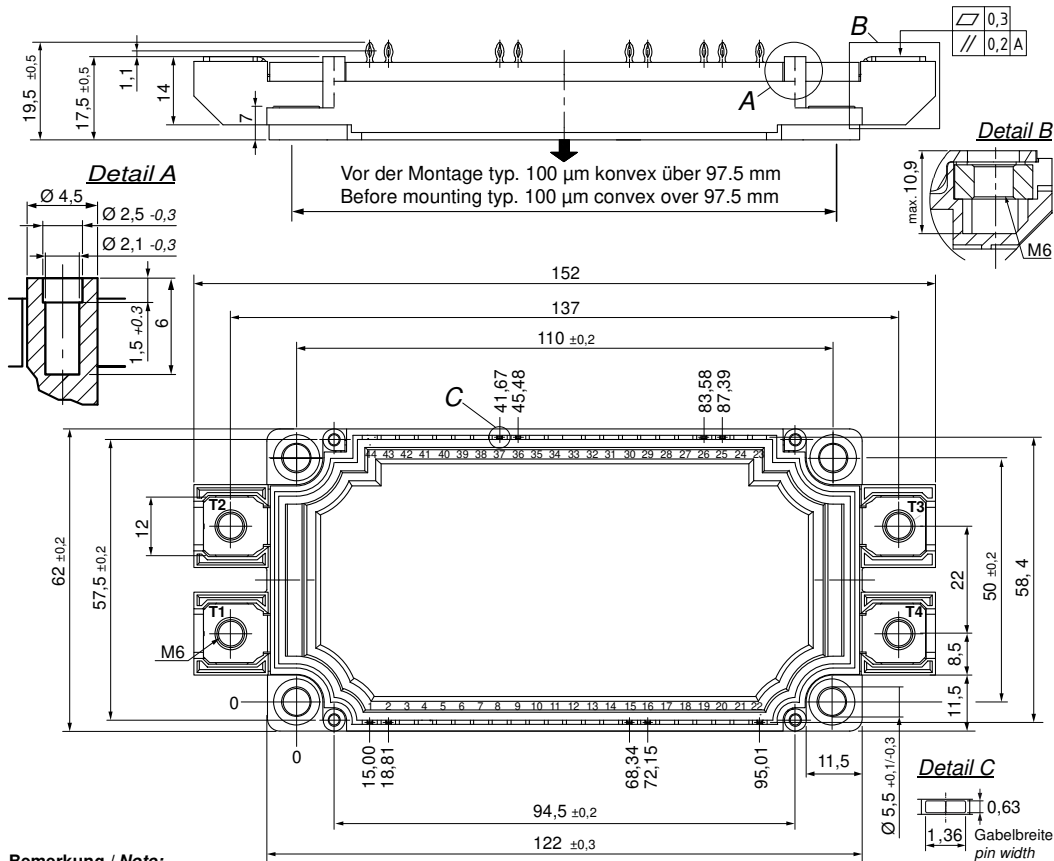

**Bemerkung / Note:**

- Nichttolerierete Maße nach / Measure w/o tolerances acc. DIN ISO 2768-T1-m
- PCB-Lochmuster / PCB hole pattern: see pin position
- Toleranz Pin-Position und PCB-Lochmuster / Tolerance of pin position and PCB hole pattern:  $\oplus 0,1$
- Bohrlochdurchmesser / Diameter of drill:  $\varnothing 1,16$  mm
- Endlochdurchmesser / Diameter of plated holes:  $\varnothing 1,00 - 1,10$  mm (Cu thickness in via typ. 50  $\mu\text{m}$ )
- Beschichtung / Plating: chem. Sn max. 15  $\mu\text{m}$
- Einpresskraft / Insert Force: per terminal with a typ. insert speed of 1 mm/s: typ. 90 N
- Weitere Angaben / Further information: [www.ixys.com](http://www.ixys.com) Application note IXAN0077
- Montageanleitung / Mounting instruction: [www.ixys.com](http://www.ixys.com) Application note IXAN0024

**Detail A:** PCB-Montage / Mounting on PCB<sup>L</sup>

- Empfohlene, selbstschneidende Schraube / Recommended, self-tapping screw: **EJOT PT®** (Größe / size: **K25**)<sup>L</sup>
- Max. Schraubenlänge / Max. screw length: **PCB-Dicke / thickness + 6 mm** (max. Lochtiefe / hole depth)<sup>L</sup>
- Empfohlenes Drehmoment / Recommended mounting torque: **1.5 Nm**

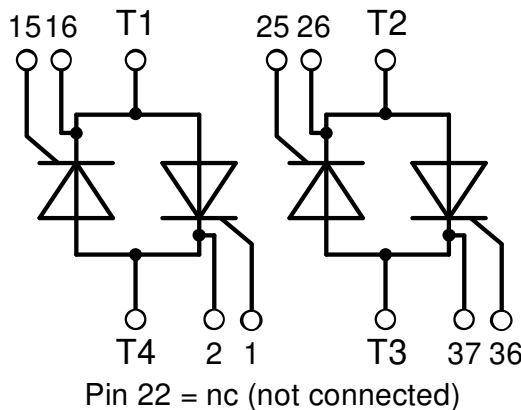

## Thyristor

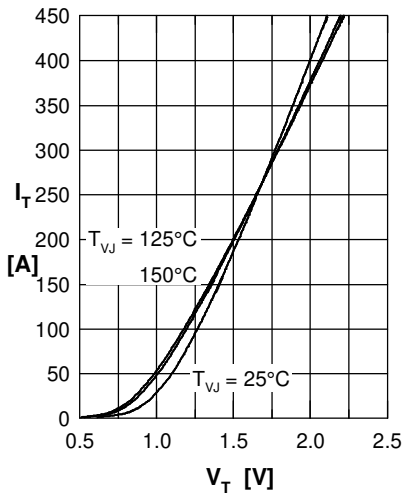

Fig. 1 Forward characteristics

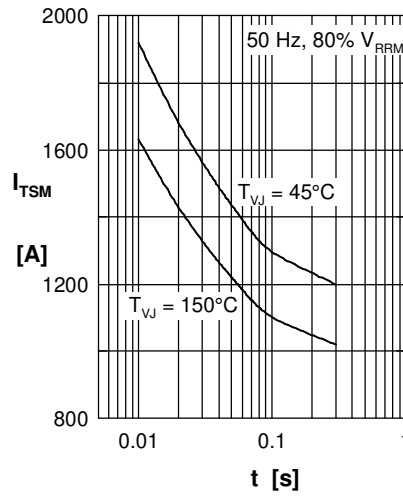

Fig. 2 Surge overload current  
 $I_{TSM}$ : crest value,  $t$ : duration

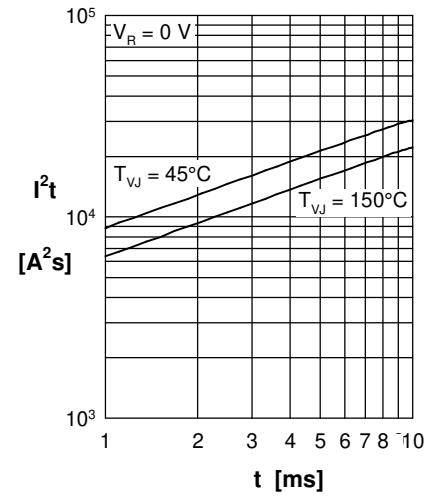

Fig. 3  $I^2t$  versus time (1-10 s)

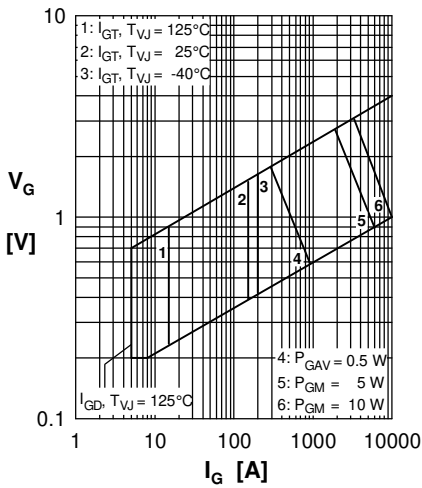

Fig. 4 Gate voltage & gate current

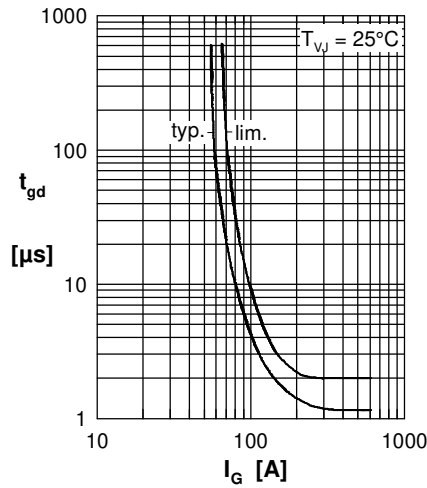

Fig. 5 Gate controlled delay time  $t_{gd}$

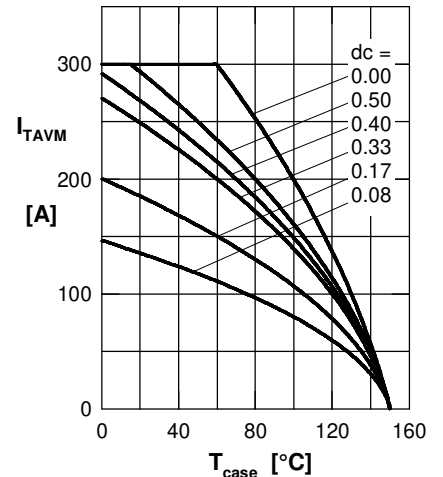

Fig. 6 Max. forward current at case temperature

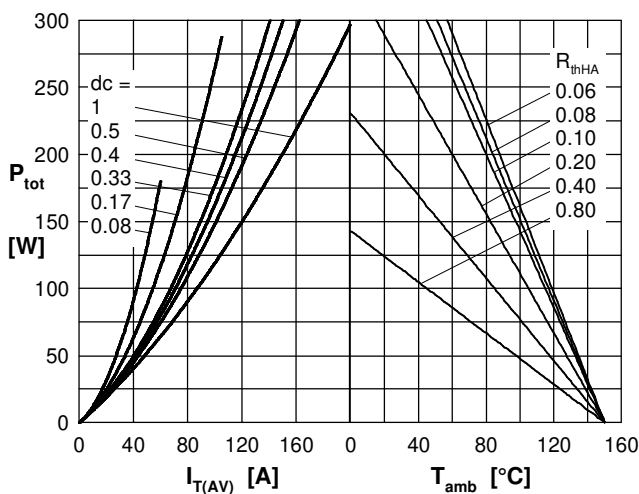

Fig. 7a Power dissipation versus direct output current  
 Fig. 7b and ambient temperature

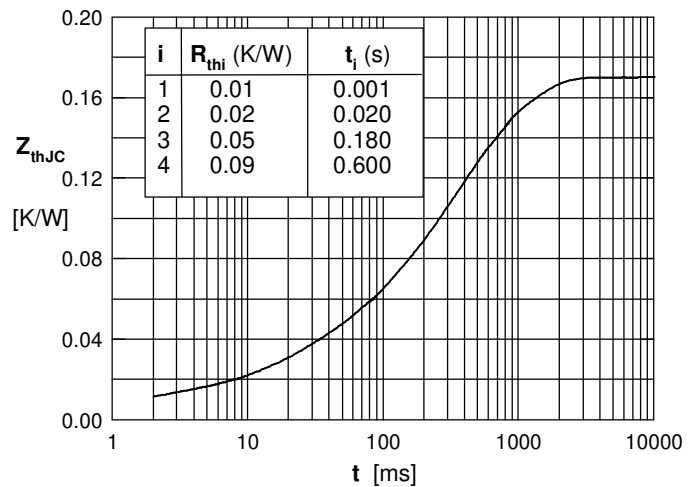

Fig. 8 Transient thermal impedance junction to case