

# High Voltage Thyristor Module

$$V_{RRM} = 2 \times 2200 \text{ V}$$

$$I_{TAV} = 650 \text{ A}$$

$$V_T = 1.16 \text{ V}$$

Phase leg

Part number

**MCNA650P2200CA**

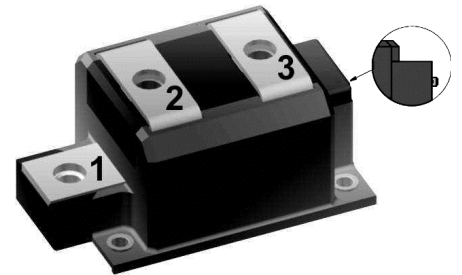

Backside: isolated

 E72873



## Features / Advantages:

- Thyristor for line frequency
- Planar passivated chip
- Long-term stability
- Direct Copper Bonded Al<sub>2</sub>O<sub>3</sub>-ceramic

## Applications:

- Line rectifying 50/60 Hz
- Softstart AC motor control
- DC Motor control
- Power converter
- AC power control
- Lighting and temperature control

## Package: ComPack

- Isolation Voltage: 4800 V~
- Industry standard outline
- RoHS compliant
- Soldering pins for PCB mounting
- Base plate: Copper internally DCB isolated
- Advanced power cycling
- Phase Change Material available

## Disclaimer Notice

Information furnished is believed to be accurate and reliable. However, users should independently evaluate the suitability of and test each product selected for their own applications. Littelfuse products are not designed for, and may not be used in, all applications. Read complete Disclaimer Notice at [www.littelfuse.com/disclaimer-electronics](http://www.littelfuse.com/disclaimer-electronics).

| Rectifier      |  |  | Ratings                    |      |       |                   |
|----------------|--|--|----------------------------|------|-------|-------------------|
| Symbol         | Definition   | Conditions   | min.                       | typ. | max.  | Unit              |
| $V_{RSM/DSM}$  | max. non-repetitive reverse/forward blocking voltage | $T_{VJ} = 25^{\circ}C$   |                            |      | 2300  | V                 |
| $V_{RRM/DRM}$  | max. repetitive reverse/forward blocking voltage     | $T_{VJ} = 25^{\circ}C$   |                            |      | 2200  | V                 |
| $I_{RD}$       | reverse current, drain current                       | $V_{R/D} = 2200 V$   | $T_{VJ} = 25^{\circ}C$     |      | 2     | mA                |
|                |  | $V_{R/D} = 2200 V$   | $T_{VJ} = 125^{\circ}C$    |      | 40    | mA                |
| $V_T$          | forward voltage drop                                 | $I_T = 650 A$  | $T_{VJ} = 25^{\circ}C$     |      | 1.19  | V                 |
|                |  | $I_T = 1300 A$   |                            |      | 1.53  | V                 |
|                |  | $I_T = 650 A$  | $T_{VJ} = 125^{\circ}C$    |      | 1.16  | V                 |
|                |  | $I_T = 1300 A$   |                            |      | 1.59  | V                 |
| $I_{TAV}$      | average forward current                              | $T_C = 85^{\circ}C$  | $T_{VJ} = 140^{\circ}C$    |      | 650   | A                 |
| $I_{T(RMS)}$   | RMS forward current                                  | 180° sine  |                            |      | 1020  | A                 |
| $V_{T0}$       | threshold voltage                                    | } for power loss calculation only  | $T_{VJ} = 140^{\circ}C$    |      | 0.75  | V                 |
| $r_T$          | slope resistance                                     |  |                            |      | 0.63  | mΩ                |
| $R_{thJC}$     | thermal resistance junction to case                  |  |                            |      | 0.045 | K/W               |
| $R_{thCH}$     | thermal resistance case to heatsink                  |  |                            | 0.02 |       | K/W               |
| $P_{tot}$      | total power dissipation                              |  | $T_C = 25^{\circ}C$        |      | 2555  | W                 |
| $I_{TSM}$      | max. forward surge current                           | $t = 10 \text{ ms}; (50 \text{ Hz}), \text{ sine}$   | $T_{VJ} = 45^{\circ}C$     |      | 16.0  | kA                |
|                |  | $t = 8,3 \text{ ms}; (60 \text{ Hz}), \text{ sine}$  | $V_R = 0 V$                |      | 17.3  | kA                |
|                |  | $t = 10 \text{ ms}; (50 \text{ Hz}), \text{ sine}$   | $T_{VJ} = 140^{\circ}C$    |      | 13.6  | kA                |
|                |  | $t = 8,3 \text{ ms}; (60 \text{ Hz}), \text{ sine}$  | $V_R = 0 V$                |      | 14.7  | kA                |
| $I^2t$         | value for fusing                                     | $t = 10 \text{ ms}; (50 \text{ Hz}), \text{ sine}$   | $T_{VJ} = 45^{\circ}C$     |      | 1.28  | MA <sup>2</sup> s |
|                |  | $t = 8,3 \text{ ms}; (60 \text{ Hz}), \text{ sine}$  | $V_R = 0 V$                |      | 1.24  | MA <sup>2</sup> s |
|                |  | $t = 10 \text{ ms}; (50 \text{ Hz}), \text{ sine}$   | $T_{VJ} = 140^{\circ}C$    |      | 924.8 | kA <sup>2</sup> s |
|                |  | $t = 8,3 \text{ ms}; (60 \text{ Hz}), \text{ sine}$  | $V_R = 0 V$                |      | 897.7 | kA <sup>2</sup> s |
| $C_J$          | junction capacitance                                 | $V_R = 700 V \quad f = 1 \text{ MHz}$  | $T_{VJ} = 25^{\circ}C$     |      | 469   | pF                |
| $P_{GM}$       | max. gate power dissipation                          | $t_p = 30 \mu s$   | $T_C = 140^{\circ}C$       |      | 120   | W                 |
|                |  | $t_p = 300 \mu s$  |                            |      | 60    | W                 |
| $P_{GAV}$      | average gate power dissipation                       |  |                            |      | 30    | W                 |
| $(di/dt)_{cr}$ | critical rate of rise of current                     | $T_{VJ} = 140^{\circ}C; f = 50 \text{ Hz}$   | repetitive, $I_T = 1950 A$ |      | 100   | A/μs              |
|                |  | $t_p = 200 \mu s; di_G/dt = 1 A/\mu s;$<br>$I_G = 1 A; V = \frac{2}{3} V_{DRM}$  | non-repet., $I_T = 650 A$  |      | 500   | A/μs              |
| $(dv/dt)_{cr}$ | critical rate of rise of voltage                     | $V = \frac{2}{3} V_{DRM}$  | $T_{VJ} = 140^{\circ}C$    |      | 1000  | V/μs              |
|                |  | $R_{GK} = \infty; \text{method 1 (linear voltage rise)}$   |                            |      |       |                   |
| $V_{GT}$       | gate trigger voltage                                 | $V_D = 6 V$  | $T_{VJ} = 25^{\circ}C$     |      | 2     | V                 |
|                |  |  | $T_{VJ} = -40^{\circ}C$    |      | 3     | V                 |
| $I_{GT}$       | gate trigger current                                 | $V_D = 6 V$  | $T_{VJ} = 25^{\circ}C$     |      | 300   | mA                |
|                |  |  | $T_{VJ} = -40^{\circ}C$    |      | 400   | mA                |
| $V_{GD}$       | gate non-trigger voltage                             | $V_D = \frac{2}{3} V_{DRM}$  | $T_{VJ} = 140^{\circ}C$    |      | 0.25  | V                 |
| $I_{GD}$       | gate non-trigger current                             |  |                            |      | 10    | mA                |
| $I_L$          | latching current                                     | $t_p = 30 \mu s$   | $T_{VJ} = 25^{\circ}C$     |      | 400   | mA                |
|                |  | $I_G = 1 A; di_G/dt = 1 A/\mu s$   |                            |      |       |                   |
| $I_H$          | holding current                                      | $V_D = 6 V \quad R_{GK} = \infty$  | $T_{VJ} = 25^{\circ}C$     |      | 300   | mA                |
| $t_{gd}$       | gate controlled delay time                           | $V_D = \frac{1}{2} V_{DRM}$  | $T_{VJ} = 25^{\circ}C$     |      | 2     | μs                |
|                |  | $I_G = 1 A; di_G/dt = 1 A/\mu s$   |                            |      |       |                   |
| $t_q$          | turn-off time  | $V_R = 100 V; I_T = 650 A; V = \frac{2}{3} V_{DRM}$<br>$di/dt = 10 A/\mu s \quad dv/dt = 50 V/\mu s \quad t_p = 200 \mu s$ | $T_{VJ} = 125^{\circ}C$    |      | 350   | μs                |



| Package ComPack |  | Ratings              |      |      |      |      |
|-----------------|--|----------------------|------|------|------|------|
| Symbol          | Definition   | Conditions           | min. | typ. | max. | Unit |
| $I_{RMS}$       | RMS current  | per terminal         |      |      | 1200 | A    |
| $T_{VJ}$        | virtual junction temperature                                 |                      | -40  |      | 140  | °C   |
| $T_{op}$        | operation temperature  |                      | -40  |      | 125  | °C   |
| $T_{stg}$       | storage temperature  |                      | -40  |      | 125  | °C   |
| <b>Weight</b>   |  |                      |      | 500  |      | g    |
| $M_D$           | mounting torque  |                      | 3    |      | 5    | Nm   |
| $M_T$           | terminal torque  |                      | 12   |      | 14   | Nm   |
| $d_{Spp/Apb}$   | creepage distance on surface   striking distance through air | terminal to terminal | 21.0 |      |      | mm   |
| $d_{Spb/Apb}$   |  | terminal to backside | 18.0 |      |      | mm   |
| $V_{ISOL}$      | isolation voltage  | t = 1 second         | 4800 |      |      | V    |
|                 |  | t = 1 minute         | 4000 |      |      | V    |

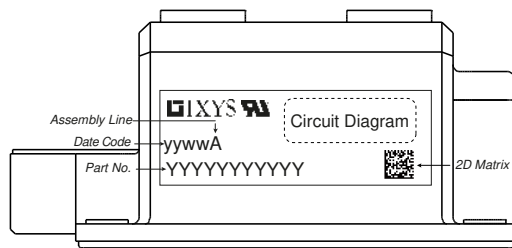

**Part description**

- M = Module
- C = Thyristor (SCR)
- N = High Voltage Thyristor
- A = (>= 2000V)
- 650 = Current Rating [A]
- P = Phase leg
- 2200 = Reverse Voltage [V]
- CA = ComPack

| Ordering | Ordering Number | Marking on Product | Delivery Mode | Quantity | Code No. |
|----------|-----------------|--------------------|---------------|----------|----------|
| Standard | MCNA650P2200CA  | MCNA650P2200CA     | Box           | 3        | 523321   |

**Equivalent Circuits for Simulation**

\* on die level

$T_{VJ} = 140^{\circ}C$



**Thyristor**

|              |                    |      |    |
|--------------|--------------------|------|----|
| $V_{0\ max}$ | threshold voltage  | 0.75 | V  |
| $R_{0\ max}$ | slope resistance * | 0.44 | mΩ |



**Outlines ComPack**

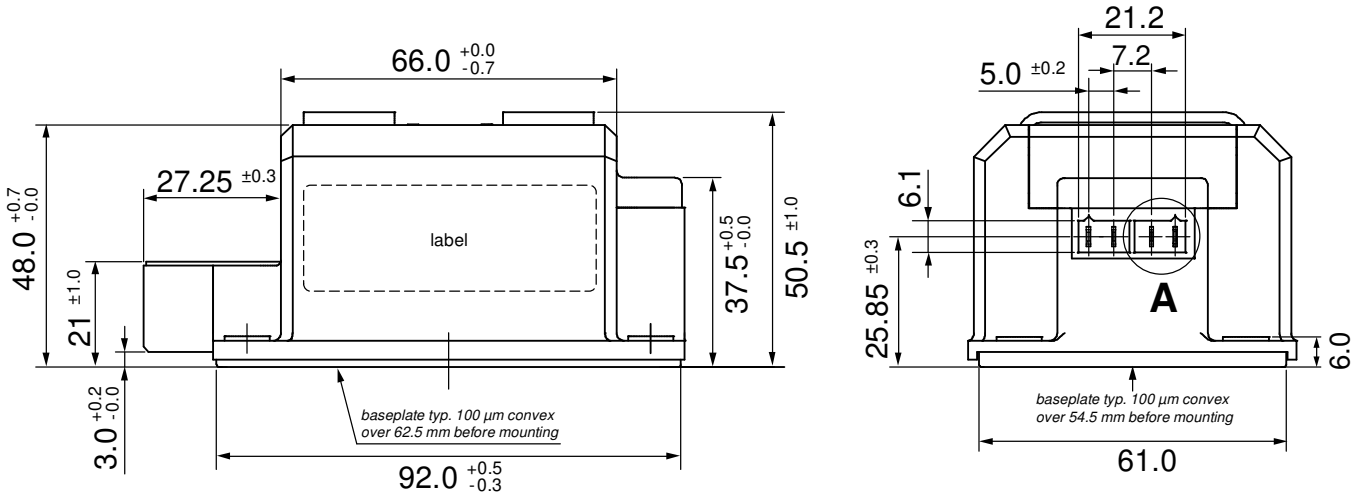

Optional accessories for modules  
 Keyed gate/cathode twin plugs with  
 wire length = 350 mm, gate = white, cathode = red  
 Type ZY 180L (L = Left for pin pair 4/5) } UL 758,  
 Type ZY 180R (R = Right for pin pair 6/7) } style 3751

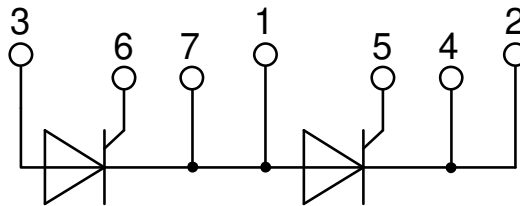
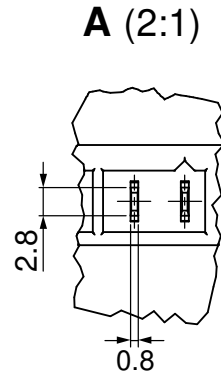
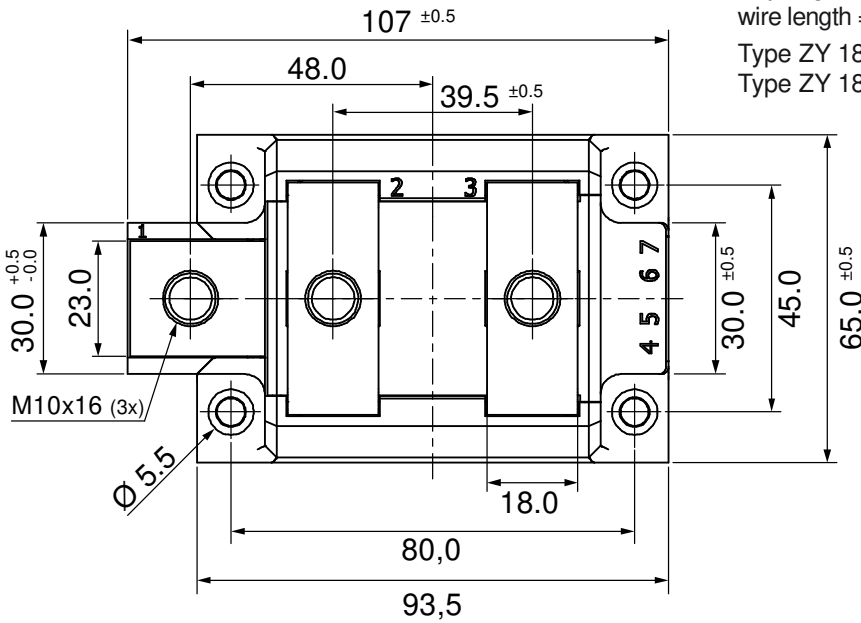

## Thyristor

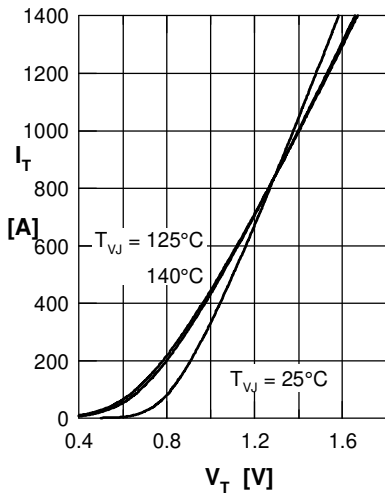

Fig. 1 Forward characteristics

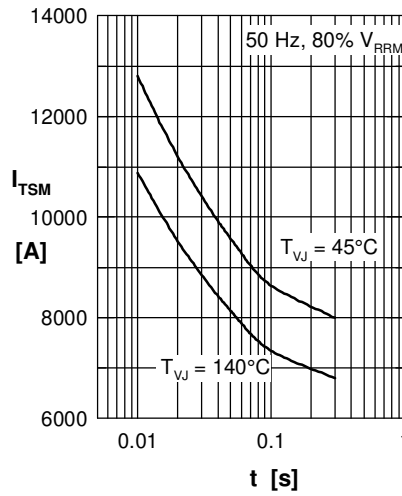

Fig. 2 Surge overload current  
 $I_{TSM}$ : crest value,  $t$ : duration

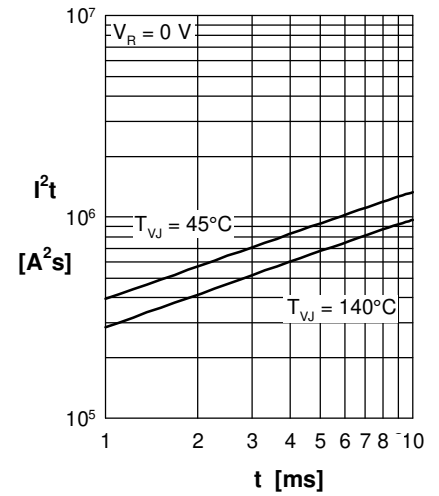

Fig. 3  $I^2t$  versus time (1-10 s)

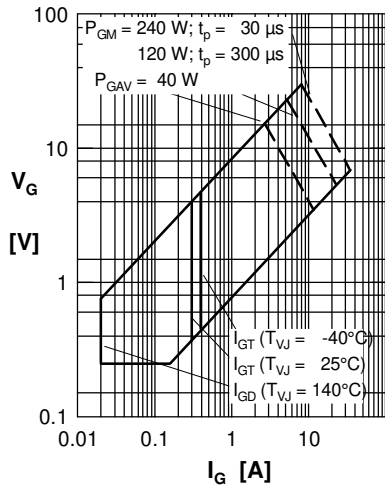

Fig. 4 Gate voltage & gate current

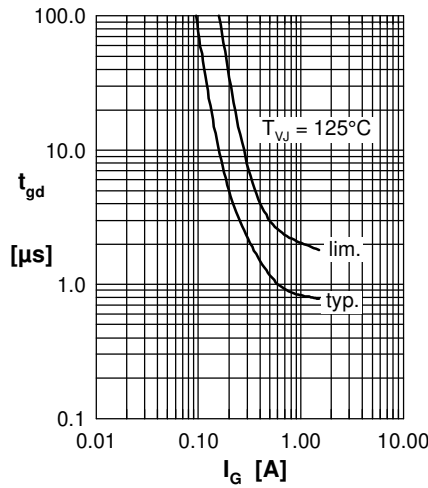

Fig. 5 Gate controlled delay time  $t_{gd}$

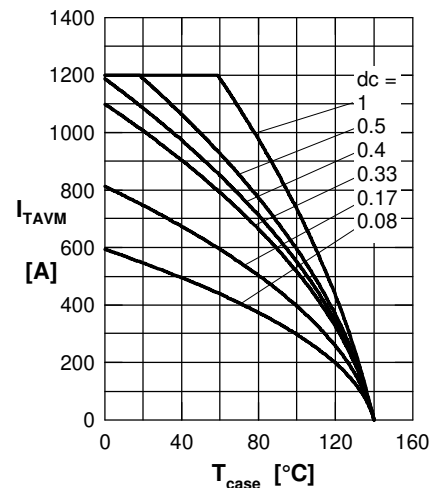

Fig. 6 Max. forward current at case temperature

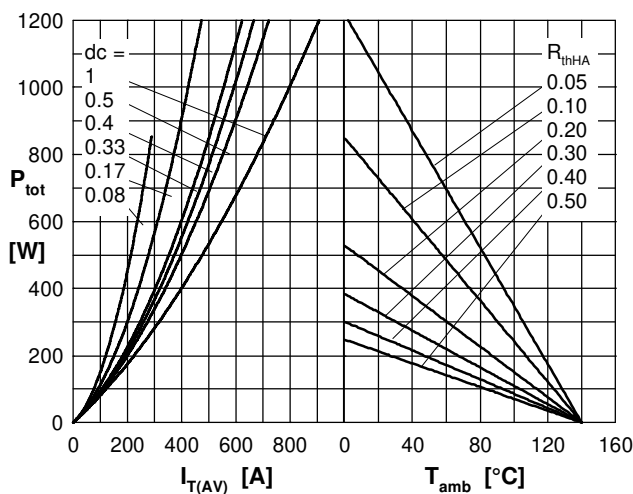

Fig. 7a Power dissipation versus direct output current  
 Fig. 7b and ambient temperature

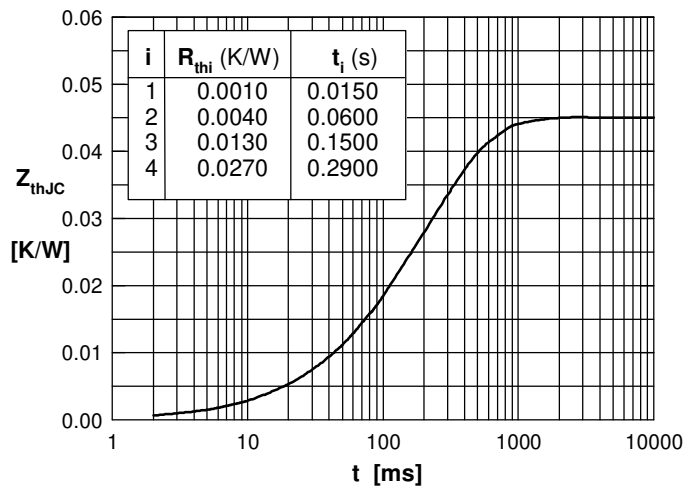

Fig. 8 Transient thermal impedance junction to case