

Standard Rectifier Module

$$V_{RRM} = 2 \times 1400 \text{ V}$$

$$I_{FAV} = 190 \text{ A}$$

$$V_F = 0.96 \text{ V}$$

Phase leg

Part number

MDD172-14N1



Backside: isolated

 E72873



Features / Advantages:

- Package with DCB ceramic
- Improved temperature and power cycling
- Planar passivated chips
- Very low forward voltage drop
- Very low leakage current

Applications:

- Diode for main rectification
- For single and three phase bridge configurations
- Supplies for DC power equipment
- Input rectifiers for PWM inverter
- Battery DC power supplies
- Field supply for DC motors

Package: Y4

- Isolation Voltage: 3600 V~
- Industry standard outline
- RoHS compliant
- Soldering pins for PCB mounting
- Base plate: DCB ceramic
- Reduced weight
- Advanced power cycling

Disclaimer Notice

Information furnished is believed to be accurate and reliable. However, users should independently evaluate the suitability of and test each product selected for their own applications. Littelfuse products are not designed for, and may not be used in, all applications. Read complete Disclaimer Notice at www.littelfuse.com/disclaimer-electronics.

Rectifier				Ratings			
Symbol	Definition	Conditions	min.	typ.	max.	Unit	
V_{RSM}	max. non-repetitive reverse blocking voltage				1500	V	
V_{RRM}	max. repetitive reverse blocking voltage				1400	V	
I_R	reverse current	$V_R = 1400\text{ V}$			1	mA	
		$V_R = 1400\text{ V}$			20	mA	
V_F	forward voltage drop	$I_F = 150\text{ A}$			1.07	V	
		$I_F = 300\text{ A}$			1.22	V	
		$I_F = 150\text{ A}$	$T_{VJ} = 125^\circ\text{C}$			0.96	V
		$I_F = 300\text{ A}$				1.16	V
I_{FAV}	average forward current	$T_C = 100^\circ\text{C}$			190	A	
$I_{F(RMS)}$	RMS forward current	180° sine			300	A	
V_{FO}	threshold voltage	} for power loss calculation only			0.80	V	
r_F	slope resistance				0.8	mΩ	
R_{thJC}	thermal resistance junction to case				0.21	K/W	
R_{thCH}	thermal resistance case to heatsink			0.08		K/W	
P_{tot}	total power dissipation		$T_C = 25^\circ\text{C}$		600	W	
I_{FSM}	max. forward surge current	$t = 10\text{ ms}; (50\text{ Hz}), \text{ sine}$	$T_{VJ} = 45^\circ\text{C}$		6.60	kA	
		$t = 8,3\text{ ms}; (60\text{ Hz}), \text{ sine}$	$V_R = 0\text{ V}$		7.13	kA	
		$t = 10\text{ ms}; (50\text{ Hz}), \text{ sine}$	$T_{VJ} = 150^\circ\text{C}$		5.61	kA	
		$t = 8,3\text{ ms}; (60\text{ Hz}), \text{ sine}$	$V_R = 0\text{ V}$		6.06	kA	
I^2t	value for fusing	$t = 10\text{ ms}; (50\text{ Hz}), \text{ sine}$	$T_{VJ} = 45^\circ\text{C}$		217.8	kA ² s	
		$t = 8,3\text{ ms}; (60\text{ Hz}), \text{ sine}$	$V_R = 0\text{ V}$		211.5	kA ² s	
		$t = 10\text{ ms}; (50\text{ Hz}), \text{ sine}$	$T_{VJ} = 150^\circ\text{C}$		157.4	kA ² s	
		$t = 8,3\text{ ms}; (60\text{ Hz}), \text{ sine}$	$V_R = 0\text{ V}$		152.8	kA ² s	
C_J	junction capacitance	$V_R = 400\text{ V}; f = 1\text{ MHz}$	$T_{VJ} = 25^\circ\text{C}$		238	pF	



Package Y4				Ratings			
Symbol	Definition	Conditions	min.	typ.	max.	Unit	
I_{RMS}	RMS current	per terminal			300	A	
T_{VJ}	virtual junction temperature		-40		150	°C	
T_{op}	operation temperature		-40		125	°C	
T_{stg}	storage temperature		-40		125	°C	
Weight				150		g	
M_D	mounting torque		2.25		2.75	Nm	
M_T	terminal torque		4.5		5.5	Nm	
$d_{Spp/App}$	creepage distance on surface striking distance through air	terminal to terminal	14.0	10.0		mm	
$d_{Spb/Apb}$		terminal to backside	16.0	16.0		mm	
V_{ISOL}	isolation voltage	t = 1 second			3600	V	
		t = 1 minute	50/60 Hz, RMS; $I_{ISOL} \leq 1$ mA		3000	V	



Data Matrix: part no. (1-19), DC + PI (20-25), lot.no.# (26-31), blank (32), serial no.# (33-36)

Ordering	Ordering Number	Marking on Product	Delivery Mode	Quantity	Code No.
Standard	MDD172-14N1	MDD172-14N1	Box	6	429716

Equivalent Circuits for Simulation

* on die level

$T_{VJ} = 150^{\circ}C$

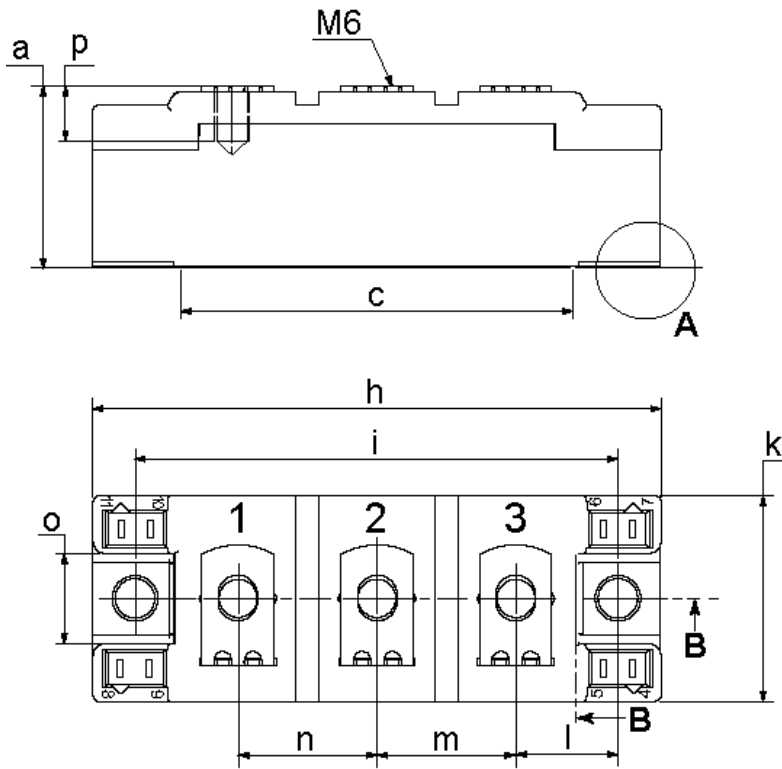


Rectifier

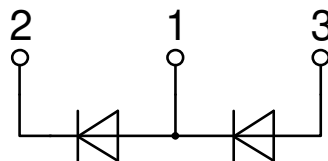
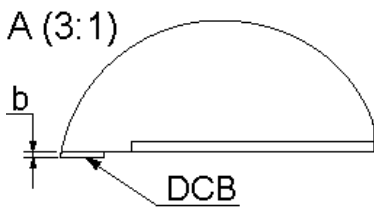
$V_{0\ max}$	threshold voltage	0.8	V
$R_{0\ max}$	slope resistance *	0.4	mΩ



Outlines Y4



Dim.	MIN [mm]	MAX [mm]	MIN [inch]	MAX [inch]
a	30.0	30.6	1.181	1.205
b	typ. 0.25		typ. 0.010	
c	64.0	65.0	2.520	2.559
d	6.5	7.0	0.256	0.275
e	4.9	5.1	0.193	0.201
h	93.5	94.5	3.681	3.720
i	79.5	80.5	3.130	3.169
k	33.4	34.0	1.315	1.339
l	16.7	17.3	0.657	0.681
m	22.7	23.3	0.894	0.917
n	22.7	23.3	0.894	0.917
o	14.0	15.0	0.551	0.591
p	typ. 10.5		typ. 0.413	



Rectifier

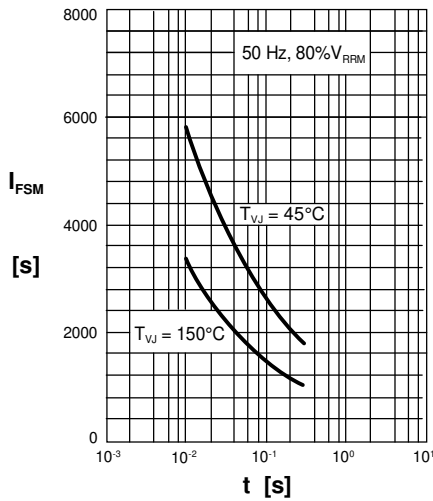


Fig. 1 Surge overload current
 I_{FSM} : Crest value, t: duration

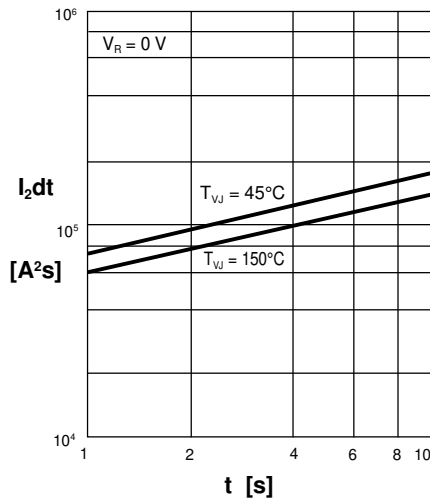


Fig. 2 I_2dt versus time (1-10 ms)

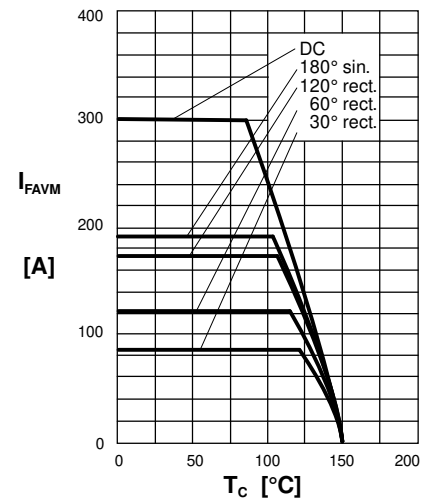


Fig. 2a Maximum forward current at case temperature

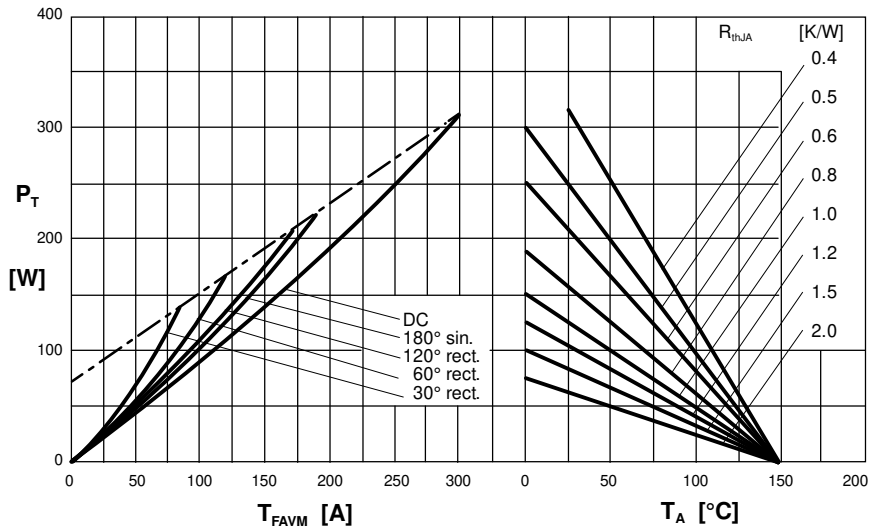


Fig. 3 Power dissipation vs. forward current and ambient temperature (per diode)

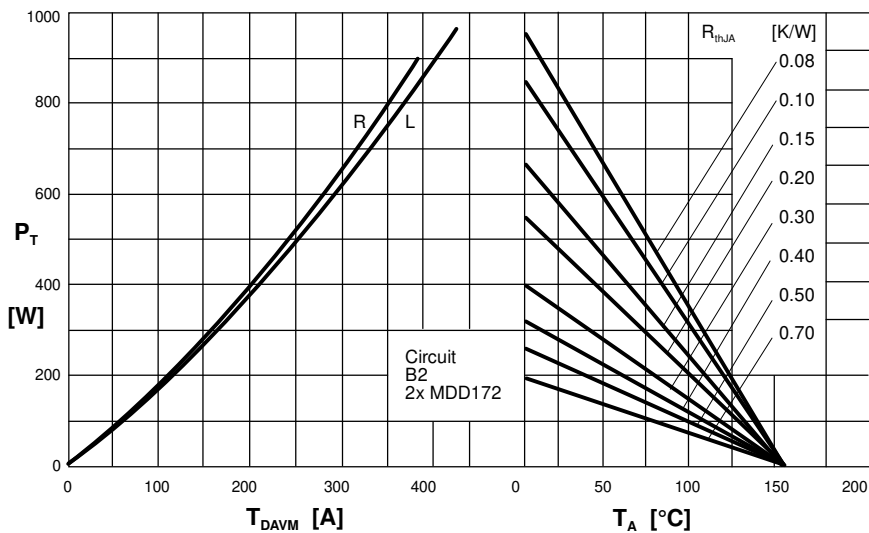


Fig. 4 Single phase rectifier bridge: Power dissipation vs. direct output current and ambient

R = resistive load
L = inductive load

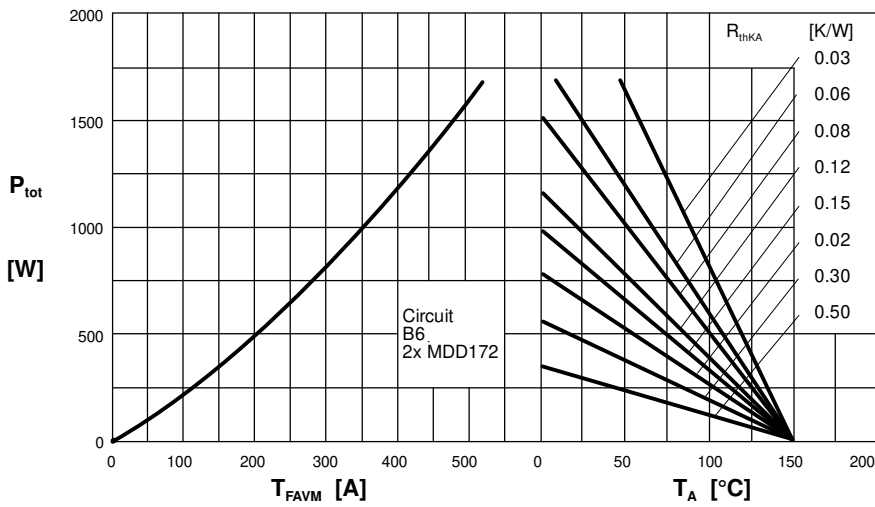
Rectifier


Fig. 5 Three phase rectifier bridge: Power dissipation vs. direct output current and ambient temperature

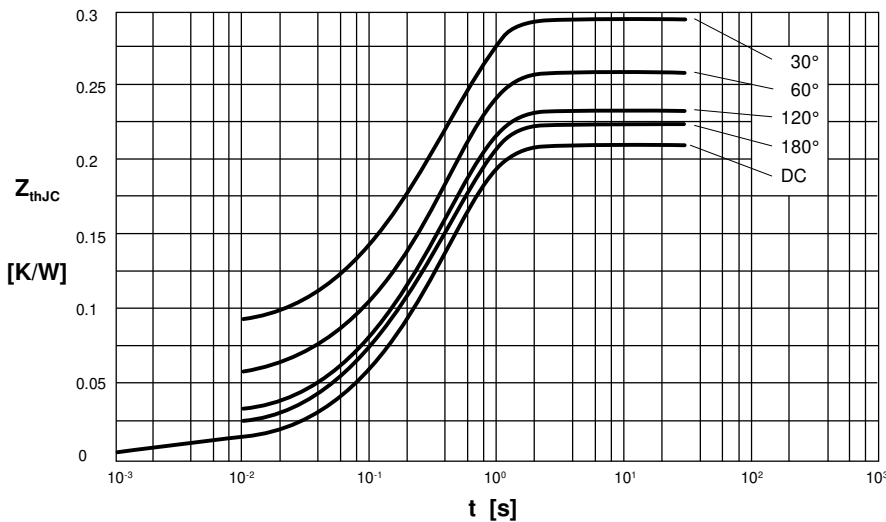


Fig. 6 Transient thermal impedance junction to case (per diode)

R_{thJC} for various conduction angles d :

d	R_{thJC} [K/W]
DC	0.210
180°	0.223
120°	0.233
60°	0.260
30°	0.295

Constants for Z_{thJC} calculation:

i	R_{thi} [K/W]	t_i [s]
1	0.0087	0.001
2	0.0163	0.065
3	0.1850	0.400

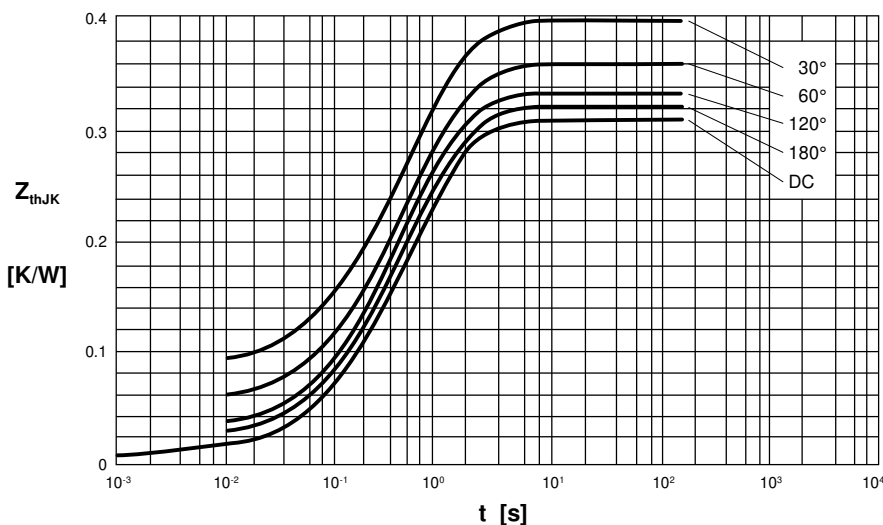


Fig. 7 Transient thermal impedance junction to heatsink (per diode)

R_{thJK} for various conduction angles d :

d	R_{thJK} [K/W]
DC	0.310
180°	0.323
120°	0.333
60°	0.360
30°	0.395

Constants for Z_{thJK} calculation:

i	R_{thi} [K/W]	t_i [s]
1	0.0087	0.001
2	0.0163	0.065
3	0.1850	0.400
4	0.1000	1.290