

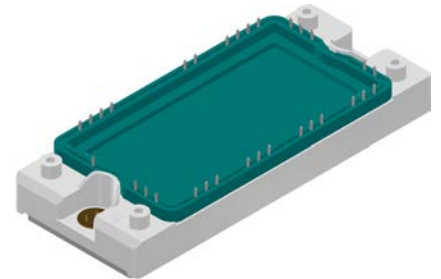
# Standard Rectifier Module

<b>3~ Rectifier</b>
$V_{RRM} = 1600\text{ V}$
$I_{DAV} = 360\text{ A}$
$I_{FSM} = 1900\text{ A}$

## 3~ Rectifier Bridge + Softstart-Thyristor

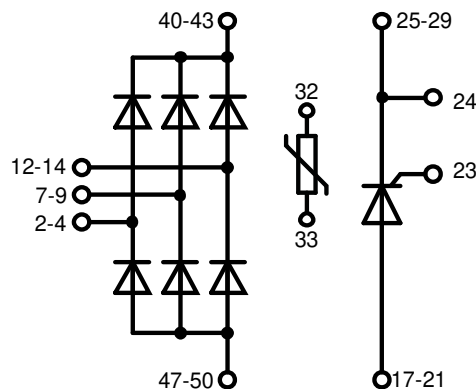
Part number

**MDMA360UC1600TED**



Backside: isolated

 E72873



### Features / Advantages:

- Package with DCB ceramic
- Improved temperature and power cycling
- Planar passivated chips
- Very low forward voltage drop
- Very low leakage current

### Applications:

- Diode for main rectification plus Softstart-Thyristor
- For three phase bridge configurations
- Supplies for DC power equipment
- Input rectifiers for PWM inverter
- Battery DC power supplies
- Field supply for DC motors

### Package: E2-Pack

- Isolation Voltage: 4300 V~
- Industry standard outline
- RoHS compliant
- PressFit-Pins for PCB mounting
- Height: 17 mm
- Base plate: Copper internally DCB isolated
- Advanced power cycling
- Phase Change Material available

### Disclaimer Notice

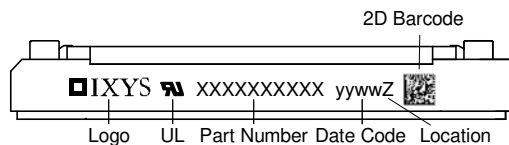
Information furnished is believed to be accurate and reliable. However, users should independently evaluate the suitability of and test each product selected for their own applications. Littelfuse products are not designed for, and may not be used in, all applications. Read complete Disclaimer Notice at [www.littelfuse.com/disclaimer-electronics](http://www.littelfuse.com/disclaimer-electronics).

Rectifier				Ratings			
Symbol	Definition	Conditions		min.	typ.	max.	Unit
$V_{RSM}$	max. non-repetitive reverse blocking voltage					1700	V
$V_{RRM}$	max. repetitive reverse blocking voltage					1600	V
$I_R$	reverse current	$V_R = 1600$ V		$T_{VJ} = 25^\circ\text{C}$		100	$\mu\text{A}$
		$V_R = 1600$ V		$T_{VJ} = 150^\circ\text{C}$		3	mA
$V_F$	forward voltage drop	$I_F = 120$ A		$T_{VJ} = 25^\circ\text{C}$		1,25	V
		$I_F = 360$ A				1,80	V
		$I_F = 120$ A		$T_{VJ} = 125^\circ\text{C}$		1,23	V
		$I_F = 360$ A				1,98	V
$I_{DAV}$	bridge output current	$T_C = 85^\circ\text{C}$		$T_{VJ} = 150^\circ\text{C}$		360	A
		rectangular	$d = \frac{1}{3}$				
$V_{FO}$	threshold voltage			$T_{VJ} = 150^\circ\text{C}$		0,82	V
$r_F$	slope resistance					3,4	m $\Omega$
						} for power loss calculation only	
$R_{thJC}$	thermal resistance junction to case					0,25	K/W
$R_{thCH}$	thermal resistance case to heatsink				0,1		K/W
$P_{tot}$	total power dissipation			$T_C = 25^\circ\text{C}$		500	W
$I_{FSM}$	max. forward surge current	$t = 10$ ms; (50 Hz), sine		$T_{VJ} = 45^\circ\text{C}$		1,90	kA
		$t = 8,3$ ms; (60 Hz), sine		$V_R = 0$ V		2,05	kA
		$t = 10$ ms; (50 Hz), sine		$T_{VJ} = 150^\circ\text{C}$		1,62	kA
		$t = 8,3$ ms; (60 Hz), sine		$V_R = 0$ V		1,75	kA
$I^2t$	value for fusing	$t = 10$ ms; (50 Hz), sine		$T_{VJ} = 45^\circ\text{C}$		18,1	kA <sup>2</sup> s
		$t = 8,3$ ms; (60 Hz), sine		$V_R = 0$ V		17,5	kA <sup>2</sup> s
		$t = 10$ ms; (50 Hz), sine		$T_{VJ} = 150^\circ\text{C}$		13,0	kA <sup>2</sup> s
		$t = 8,3$ ms; (60 Hz), sine		$V_R = 0$ V		12,7	kA <sup>2</sup> s
$C_J$	junction capacitance	$V_R = 400$ V; $f = 1$ MHz		$T_{VJ} = 25^\circ\text{C}$		10	pF

Softstart-Thyristor			Ratings				
Symbol	Definition	Conditions	min.	typ.	max.	Unit	
$V_{RSM/DSM}$	max. non-repetitive reverse/forward blocking voltage				1700	V	
$V_{RRM/DRM}$	max. repetitive reverse/forward blocking voltage				1600	V	
$I_{RD}$	reverse current, drain current	$V_{RD} = 1600$ V			100	$\mu$ A	
		$V_{RD} = 1600$ V			15	mA	
$V_T$	forward voltage drop	$I_T = 150$ A			1.34	V	
		$I_T = 300$ A			1.73	V	
		$I_T = 150$ A	$T_{VJ} = 125^\circ$ C			1.31	V
		$I_T = 300$ A				1.77	V
$I_{TAV}$	average forward current	$T_C = 90^\circ$ C 180° sine			150	A	
$V_{TO}$	threshold voltage	} for power loss calculation only			0.84	V	
$r_T$	slope resistance				3.1	m $\Omega$	
$R_{thJC}$	thermal resistance junction to case				0.17	K/W	
$R_{thCH}$	thermal resistance case to heatsink		0.080			K/W	
$P_{tot}$	total power dissipation				735	W	
$I_{TSM}$	max. forward surge current	t = 10 ms; (50 Hz), sine	$T_{VJ} = 45^\circ$ C		2.40	kA	
		t = 8,3 ms; (60 Hz), sine	$V_R = 0$ V		2.59	kA	
		t = 10 ms; (50 Hz), sine	$T_{VJ} = 150^\circ$ C			2.04	kA
		t = 8,3 ms; (60 Hz), sine	$V_R = 0$ V			2.21	kA
$I^2t$	value for fusing	t = 10 ms; (50 Hz), sine	$T_{VJ} = 45^\circ$ C		28.8	kA <sup>2</sup> s	
		t = 8,3 ms; (60 Hz), sine	$V_R = 0$ V		27.9	kA <sup>2</sup> s	
		t = 10 ms; (50 Hz), sine	$T_{VJ} = 150^\circ$ C			20.8	kA <sup>2</sup> s
		t = 8,3 ms; (60 Hz), sine	$V_R = 0$ V			20.2	kA <sup>2</sup> s
$C_J$	junction capacitance	$V_R = 400$ V f = 1 MHz	$T_{VJ} = 25^\circ$ C	119		pF	
$P_{GM}$	max. gate power dissipation	$t_p = 30$ $\mu$ s	$T_C = 150^\circ$ C		10	W	
		$t_p = 300$ $\mu$ s			5	W	
$P_{GAV}$	average gate power dissipation				0.5	W	
$(di/dt)_{cr}$	critical rate of rise of current	$T_{VJ} = 150^\circ$ C; f = 50 Hz	repetitive, $I_T = 450$ A		150	A/ $\mu$ s	
		$t_p = 200$ $\mu$ s; $di_G/dt = 0.45$ A/ $\mu$ s; $I_G = 0.45$ A; $V = \frac{2}{3} V_{DRM}$	non-repet., $I_T = 150$ A			500	A/ $\mu$ s
$(dv/dt)_{cr}$	critical rate of rise of voltage	$V = \frac{2}{3} V_{DRM}$ $R_{GK} = \infty$ method 1 (linear voltage rise)	$T_{VJ} = 150^\circ$ C		1000	V/ $\mu$ s	
$V_{GT}$	gate trigger voltage	$V_D = 6$ V	$T_{VJ} = 25^\circ$ C		1.5	V	
			$T_{VJ} = -40^\circ$ C			1.6	V
$I_{GT}$	gate trigger current	$V_D = 6$ V	$T_{VJ} = 25^\circ$ C		150	mA	
			$T_{VJ} = -40^\circ$ C			200	mA
$V_{GD}$	gate non-trigger voltage	$V_D = \frac{2}{3} V_{DRM}$	$T_{VJ} = 150^\circ$ C		0.2	V	
$I_{GD}$	gate non-trigger current				10	mA	
$I_L$	latching current	$t_p = 10$ $\mu$ s	$T_{VJ} = 25^\circ$ C		200	mA	
		$I_G = 0.45$ A; $di_G/dt = 0.45$ A/ $\mu$ s					
$I_H$	holding current	$V_D = 6$ V $R_{GK} = \infty$	$T_{VJ} = 25^\circ$ C		200	mA	
$t_{gd}$	gate controlled delay time	$V_D = \frac{1}{2} V_{DRM}$	$T_{VJ} = 25^\circ$ C		2	$\mu$ s	
		$I_G = 0.45$ A; $di_G/dt = 0.45$ A/ $\mu$ s					
$t_q$	turn-off time	$V_R = 100$ V; $I_T = 150$ A; $V = \frac{2}{3} V_{DRM}$ $di/dt = 10$ A/ $\mu$ s $dv/dt = 20$ V/ $\mu$ s $t_p = 200$ $\mu$ s	$T_{VJ} = 125^\circ$ C	185		$\mu$ s	



Package E2-Pack		Ratings				
Symbol	Definition	Conditions	min.	typ.	max.	Unit
$I_{RMS}$	RMS current	per terminal			50	A
$T_{VJ}$	virtual junction temperature		-40		150	°C
$T_{op}$	operation temperature		-40		125	°C
$T_{stg}$	storage temperature		-40		125	°C
<b>Weight</b>				176		g
$M_D$	mounting torque		3		6	Nm
$d_{Spp/App}$	creepage distance on surface   striking distance through air	terminal to terminal	6,0			mm
$d_{Spb/Apb}$		terminal to backside	12,0			mm
$V_{ISOL}$	isolation voltage	t = 1 second t = 1 minute	4300			V
		50/60 Hz, RMS; $I_{ISOL} \leq 1$ mA	3600			V



**Part description**

- M = Module
- D = Diode
- M = Standard Rectifier
- A = (up to 1800V)
- 360 = Current Rating [A]
- UC = 3- Rectifier Bridge + Softstart-Thyristor
- 1600 = Reverse Voltage [V]
- T = Thermistor \ Temperature sensor
- ED = E2-Pack

Ordering	Ordering Number	Marking on Product	Delivery Mode	Quantity	Code No.
Standard	MDMA360UC1600TED	MDMA360UC1600TED	Box	6	524541

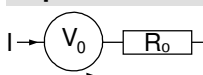
**Temperature Sensor NTC**

Symbol	Definition	Conditions	min.	typ.	max.	Unit
$R_{25}$	resistance	$T_{VJ} = 25^\circ$	4,85	5	5,15	k $\Omega$
$B_{25/50}$	temperature coefficient			3375		K

**Equivalent Circuits for Simulation**

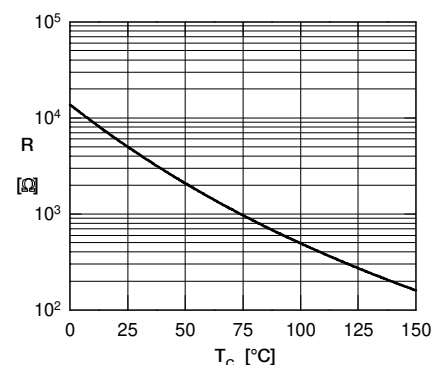
\* on die level

$T_{VJ} = 150^\circ\text{C}$



Rectifier

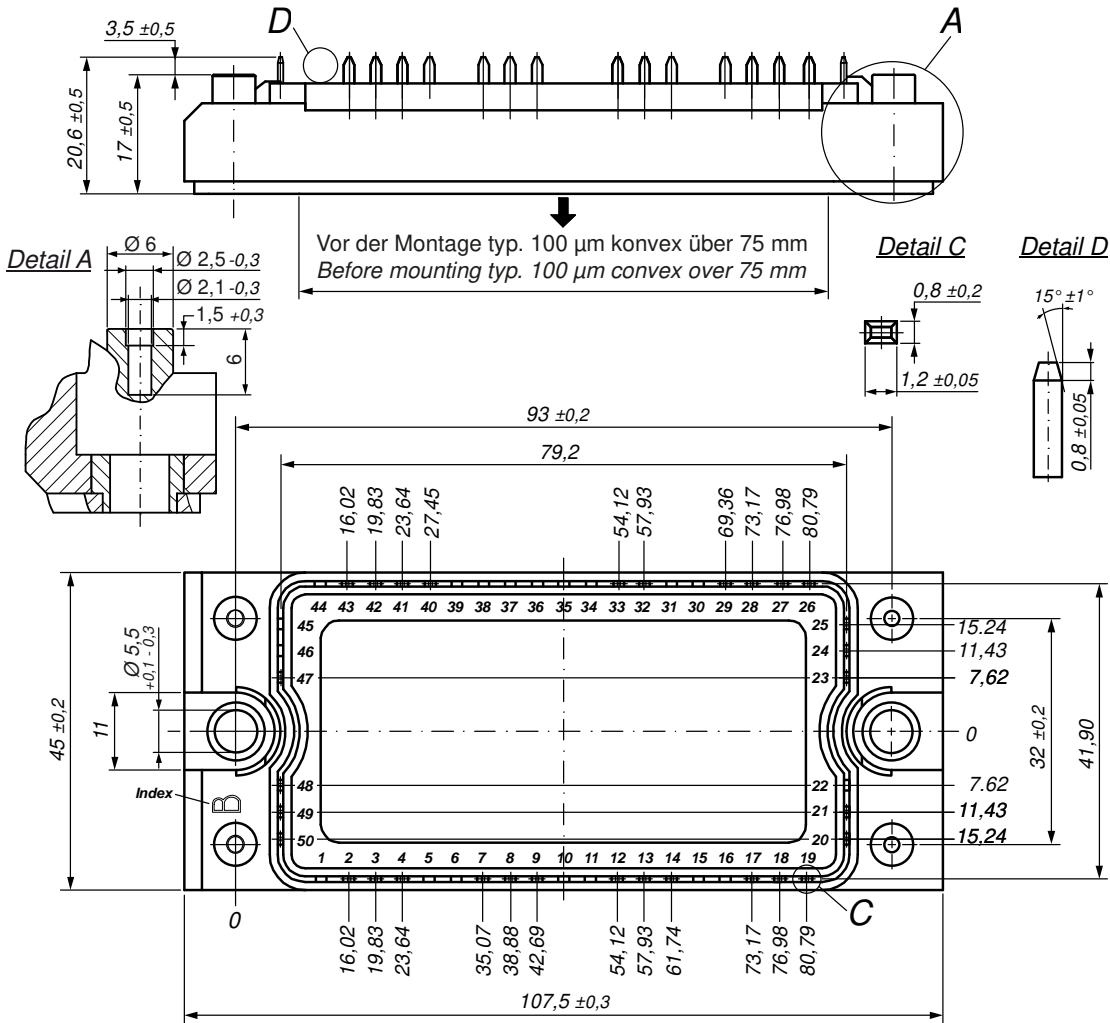
$V_{0 \max}$	threshold voltage	0,82				V
$R_{0 \max}$	slope resistance *	10,2				m $\Omega$



Typ. NTC resistance vs. temperature



**Outlines E2-Pack**

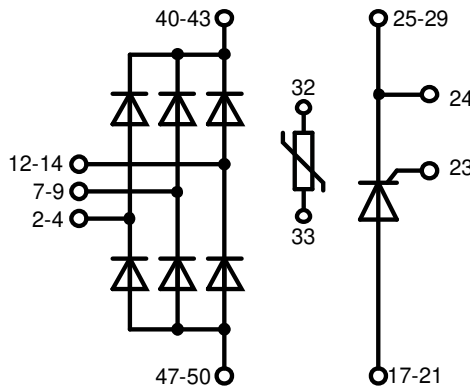


**Bemerkung / Note:**

- Nichttolerierete Maße nach / *Measure without tolerances according DIN ISO 2768-T1-m*
- PCB-Lochmuster / *PCB hole pattern: see pin position*
- Toleranz Pin-Position und PCB-Lochmuster / *Tolerance of pin position and PCB hole pattern:  $\oplus 0.1$*
- Montageanleitung / *Mounting instruction: www.ixys.com Application note IXAN0024*

**Detail A:** PCB-Montage / *Mounting on PCB*

- Empfohlene, selbstschneidende Schraube / *Recommended, self-tapping screw: EJOT PT® (Größe / size: K25)*
- Max. Schraubenlänge / *Max. screw length: PCB-Dicke / thickness + 6 mm (max. Lochtiefe / hole depth)*
- Empfohlenes Drehmoment / *Recommended mounting torque: 1.5 Nm*



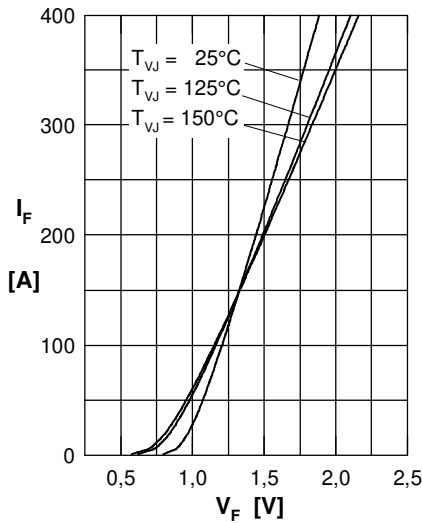
**Rectifier**


Fig. 1 Forward current versus voltage drop per diode

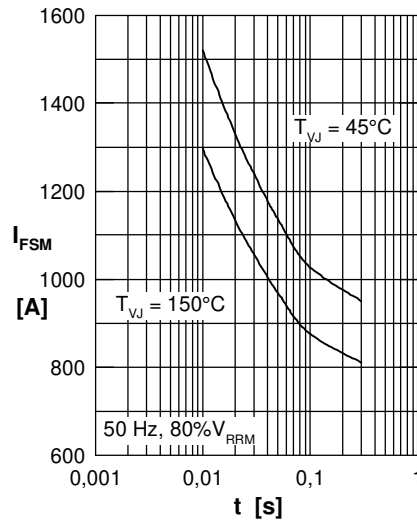


Fig. 2 Surge overload current vs. time per diode

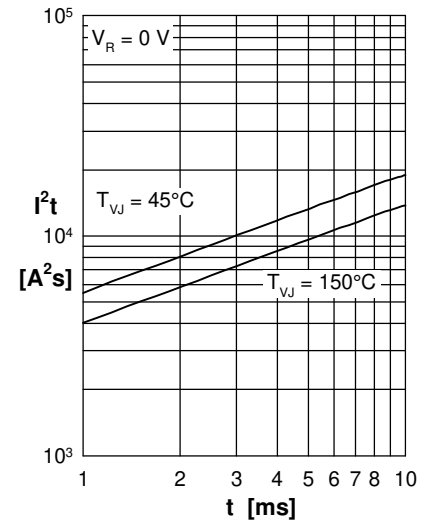
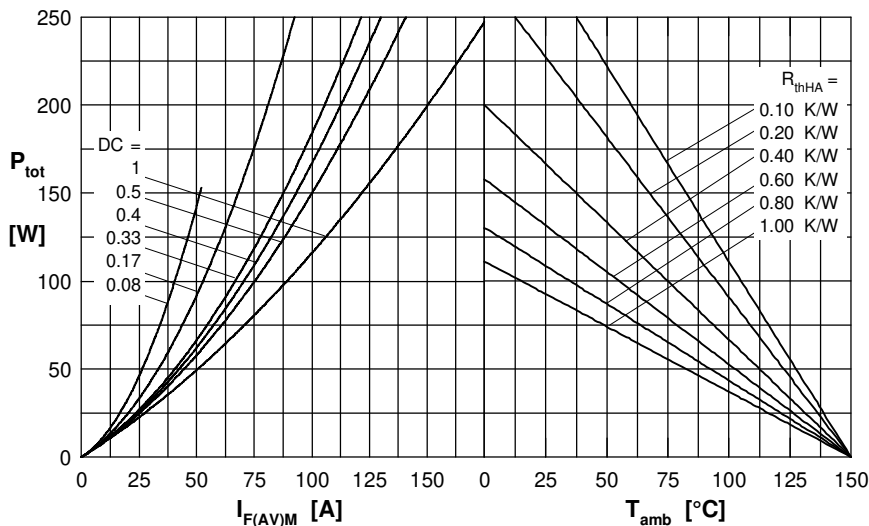

 Fig. 3  $I^2t$  versus time per diode


Fig. 4 Power dissipation vs. forward current and ambient temperature per diode

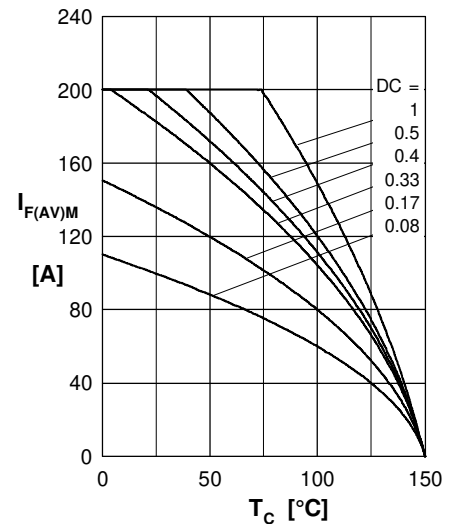


Fig. 5 Max. forward current vs. case temperature per diode

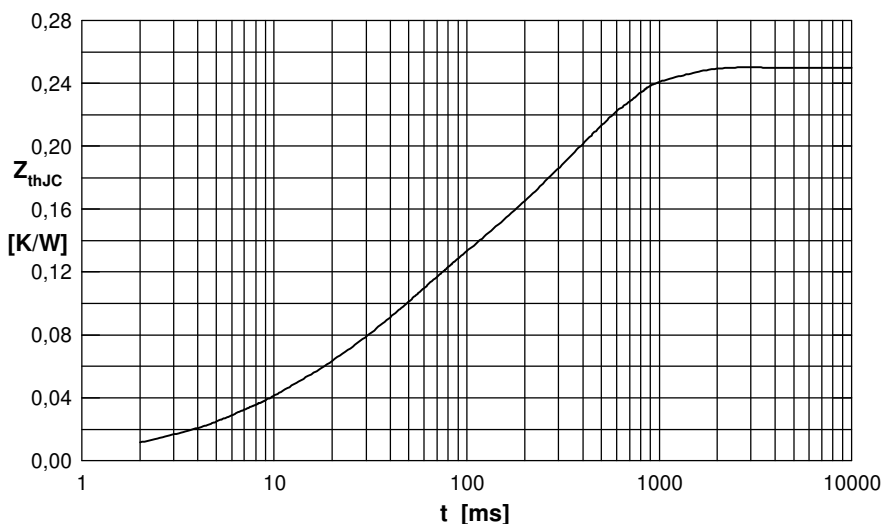


Fig. 6 Transient thermal impedance junction to case vs. time per diode

 Constants for  $Z_{thJC}$  calculation:

i	$R_{thi}$ (K/W)	$t_i$ (s)
1	0.020	0.006
2	0.003	0.007
3	0.080	0.037
4	0.147	0.360

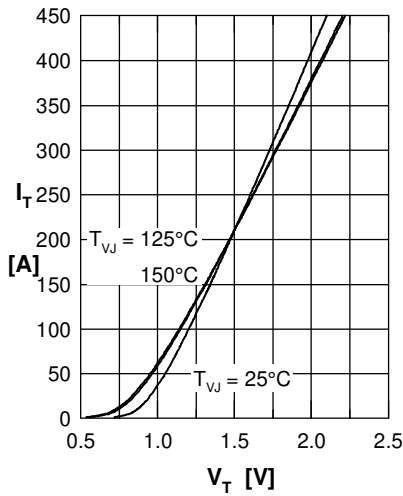
**Softstart Thyristor**


Fig. 1 Forward characteristics

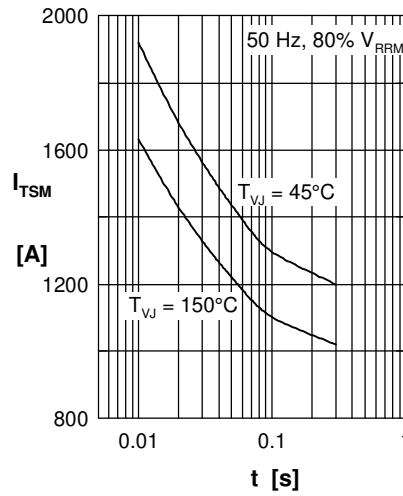
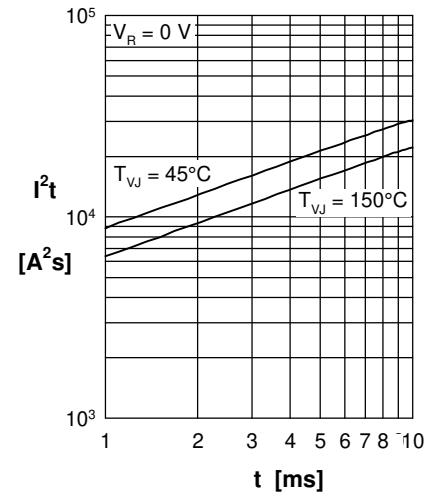
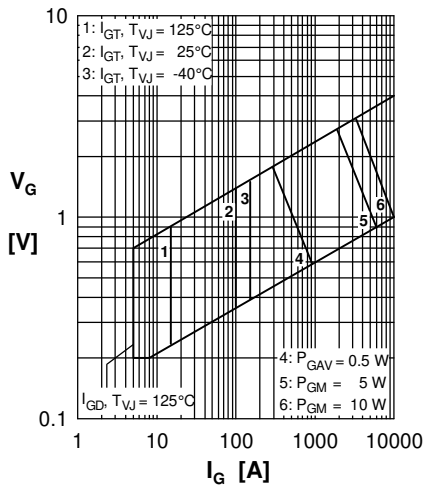

 Fig. 2 Surge overload current  
 $I_{TSM}$ : crest value, t: duration

 Fig. 3  $I^2t$  versus time (1-10 s)


Fig. 4 Gate voltage &amp; gate current

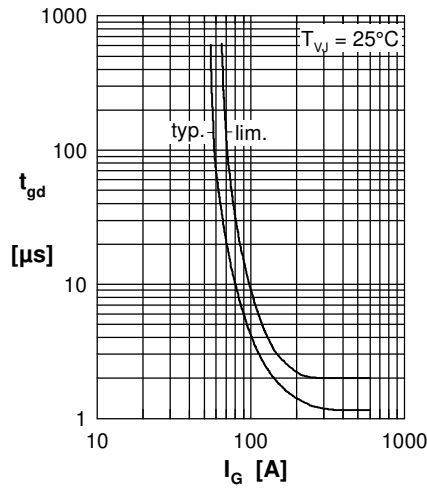
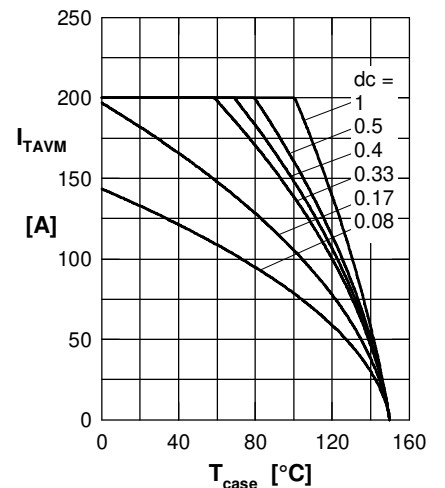

 Fig. 5 Gate controlled delay time  $t_{gd}$ 


Fig. 6 Max. forward current at case temperature

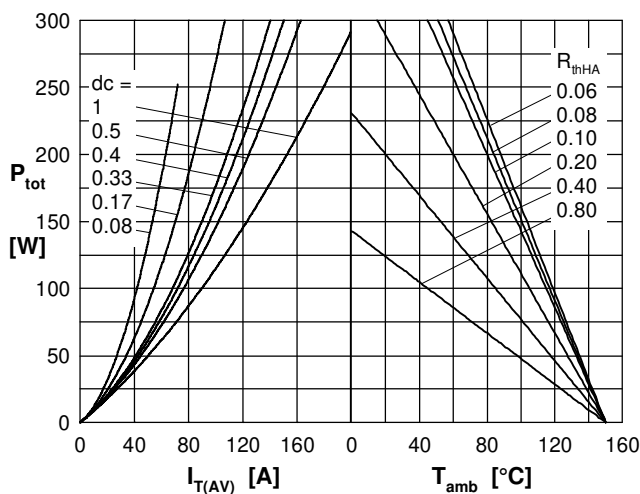
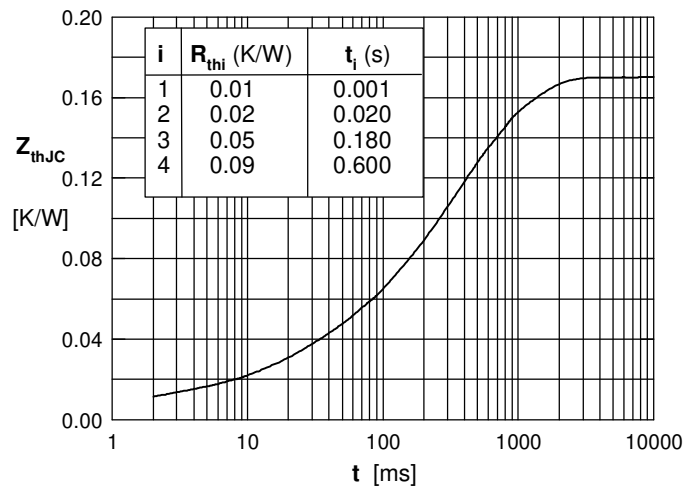

 Fig. 7a Power dissipation versus direct output current  
 Fig. 7b and ambient temperature


Fig. 8 Transient thermal impedance junction to case