

FRED Module

 $V_{RRM} = 1200\text{ V}$
 $I_{FAV} = 75\text{ A}$
 $t_{rr} = 230\text{ ns}$

Fast Recovery Epitaxial Diode

Part number

MEA 75-12DA
 MEK 75-12DA
 MEE 75-12DA

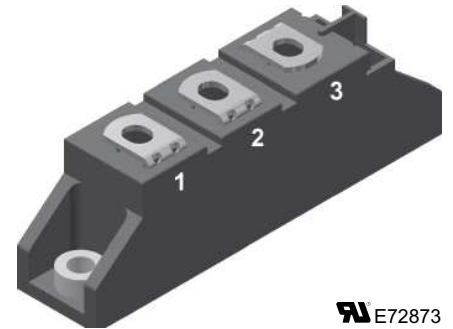

 E72873
 Backside: isolated

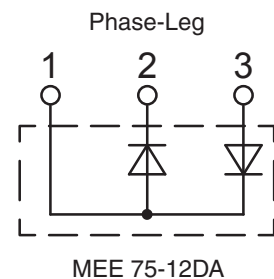
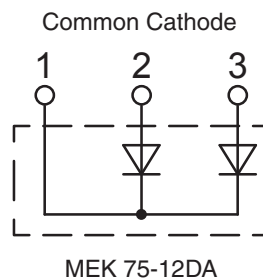
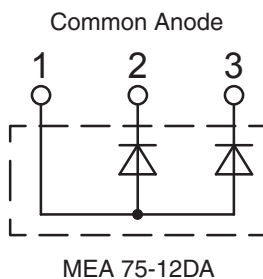

Features / Advantages:

- Planar passivated chips
- Low switching losses
- Soft recovery behaviour
- High reliability circuit operation
- Low voltage peaks for reduced protection circuits
- Low noise switching
- Low losses

Applications:

- Antiparallel diode for high frequency switching devices
- Free wheeling diode in converters and motor control circuits
- Inductive heating and melting
- Uninterruptible power supplies (UPS)
- Ultrasonic cleaners and welders

Package: TO-240AA

- Isolation voltage: 4800 V~
- Industry standard outline
- RoHS compliant
- Height: 30 mm
- Base plate: DCB ceramic
- Reduced weight
- Advanced power cycling

Disclaimer Notice

Information furnished is believed to be accurate and reliable. However, users should independently evaluate the suitability of and test each product selected for their own applications. Littelfuse products are not designed for, and may not be used in, all applications. Read complete Disclaimer Notice at www.littelfuse.com/disclaimer-electronics.



Diode				Ratings			
Symbol	Definitions	Conditions	min.	typ.	max.		
V_{RSM}	max. non-repetitive reverse blocking voltage		$T_{VJ} = 25^{\circ}C$		1200		V
V_{RRM}	max. repetitive reverse blocking voltage		$T_{VJ} = 25^{\circ}C$		1200		V
I_R	reverse current	$V_R = V_{RRM}$ $V_R = 0.8 \cdot V_{RRM}$ $V_R = 0.8 \cdot V_{RRM}$	$T_{VJ} = 25^{\circ}C$		2		mA
			$T_{VJ} = 25^{\circ}C$		0.5		mA
			$T_{VJ} = 125^{\circ}C$		34		mA
V_F	forward voltage	$I_F = 100 A$ $I_F = 300 A$	$T_{VJ} = 25^{\circ}C$		2.17		V
			$T_{VJ} = 125^{\circ}C$		1.85		V
			$T_{VJ} = 25^{\circ}C$		2.64		V
			$T_{VJ} = 125^{\circ}C$		2.58		V
I_{FRMS}	RMS forward current		$T_C = 75^{\circ}C$		107		A
I_{FAV} ①	average forward current	$T_C = 75^{\circ}C$ rectangular, d = 0.5	$T_{VJ} = 150^{\circ}C$		75		A
V_{TO}	threshold voltage	for power-loss calculations only	$T_{VJ} = T_{VJM}$		1.48		V
r_T	slope resistance				3.65		m Ω
R_{thJC}	thermal resistance junction to case			0.10	0.45		K/W
R_{thCH}	thermal resistance junction to heatsink						K/W
P_{tot}			$T_C = 25^{\circ}C$		280		W
I_{FSM}	max. surge forward current	t = 10 ms (50 Hz), sine t = 8.3 ms (60 Hz), sine t = 10 ms (50 Hz), sine t = 8.3 ms (60 Hz), sine	$T_{VJ} = 45^{\circ}C$		1200		A
					1300		A
			$T_{VJ} = 150^{\circ}C$		1080		A
					1170		A
I^2t	I^2t value for fusing	t = 10 ms (50 Hz), sine t = 8.3 ms (60 Hz), sine t = 10 ms (50 Hz), sine t = 8.3 ms (60 Hz), sine	$T_{VJ} = 45^{\circ}C$		7200		A ² s
					7100		A ² s
			$T_{VJ} = 150^{\circ}C$		5800		A ² s
					5700		A ² s
t_{rr}	max. reverse recovery current	$I_F = 70 A; V_R = 600 V$ -di/dt = 400 A/ μ s; L \leq 0.05 μ H	$T_{VJ} = 25^{\circ}C$		140	200	ns
			$T_{VJ} = 100^{\circ}C$		230	300	ns
I_{RM}	reverse recovery time		$T_{VJ} = 25^{\circ}C$		25	30	A
			$T_{VJ} = 100^{\circ}C$		33	40	A

① I_{FAVM} rating includes reverse blocking losses at T_{VJM} , $V_R = 0.8 V_{RRM}$, duty cycle d = 0.5



Package TO-240AA			Ratings			
Symbol	Definitions	Conditions	min.	typ.	max.	
I_{RMS}	RMS current	per terminal			200	A
T_{VJ}	virtual junction temperature		-40		150	°C
T_{op}	operation temperature		-40		125	°C
T_{stg}	storage temperature		-40		125	°C
Weight				76		g
M_D	mounting torque		2.5		4	Nm
M_T	terminal torque		2.5		4	Nm
$d_{Spp/App}$	creepage distance on surface striking distance through air	terminal to terminal	13.0	9.7		mm
$d_{Spb/Apb}$		terminal to backside	16.0	16.0		mm
V_{ISOL}	isolation voltage	t = 1 second	50/60 Hz, RMS; $I_{ISOL} \leq 1$ mA		4800	V
		t = 1 minute			4000	V

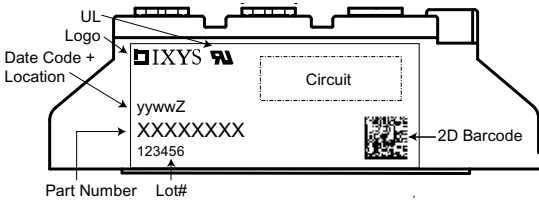

Ordering	Part Name	Marking on Product	Delivering Mode	Base Qty	Ordering Code
Standard	MEA 75-12DA	MEA 75-12DA	Box	36	469130
Standard	MEK 75-12DA	MEK 75-12DA	Box	36	468541
Standard	MEE 75-12DA	MEE 75-12DA	Box	36	469297

Outlines TO-240AA

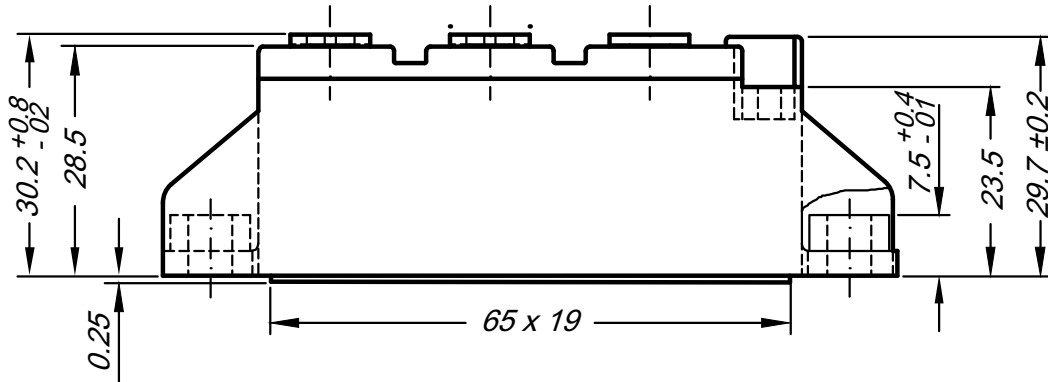

General tolerance: DIN ISO 2768 class „c“

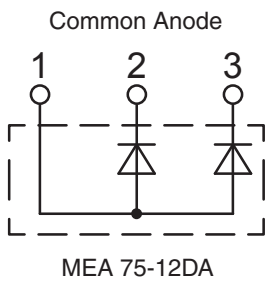
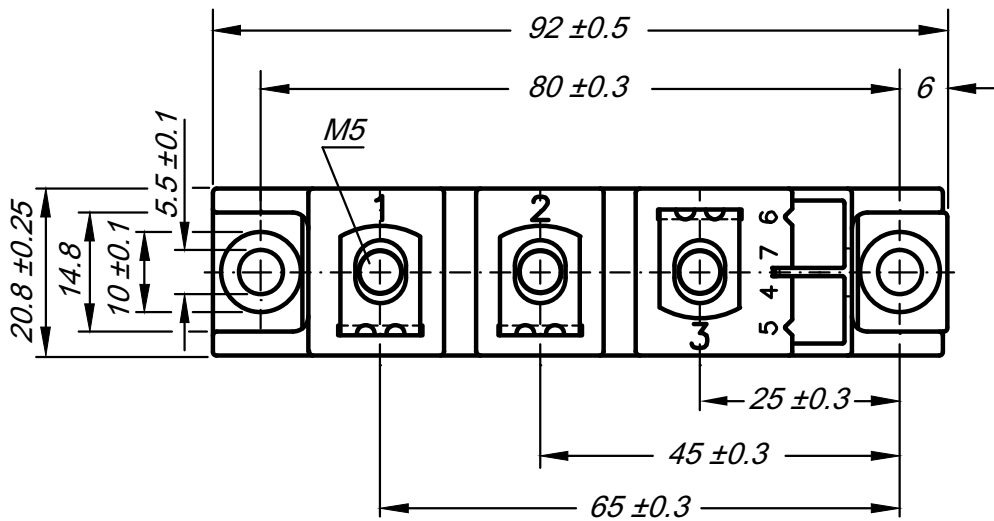

MEA 75-12DA

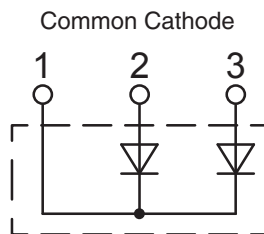

MEK 75-12DA

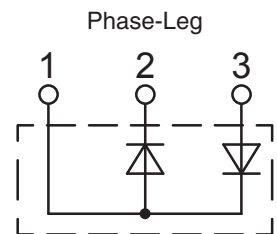

MEE 75-12DA

Curves

 Fig. 1 Typ. forward current I_F vs. voltage drop V_F per leg

 Fig. 2 Typ. reverse recovery charge Q_r versus $-di_F/dt$

 Fig. 3 Typ. peak reverse current I_{RM} versus $-di_F/dt$

 Fig. 4 Typ. dynamic parameters Q_r , I_{RM} vs. junction temperature T_{VJ}

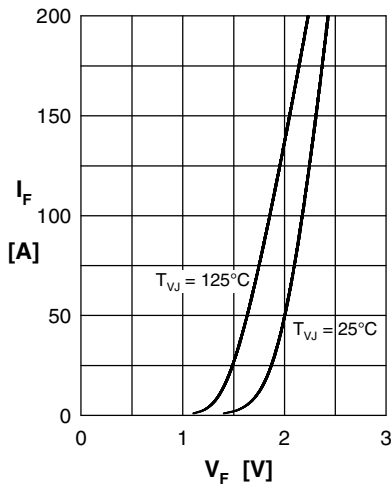
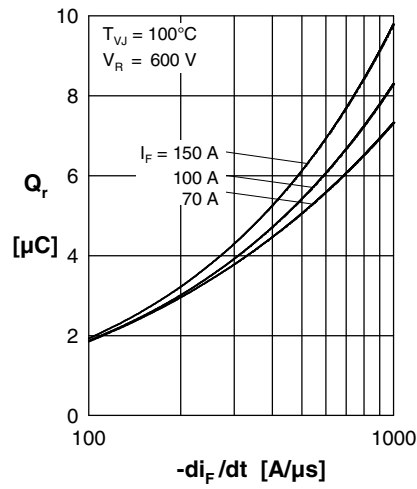
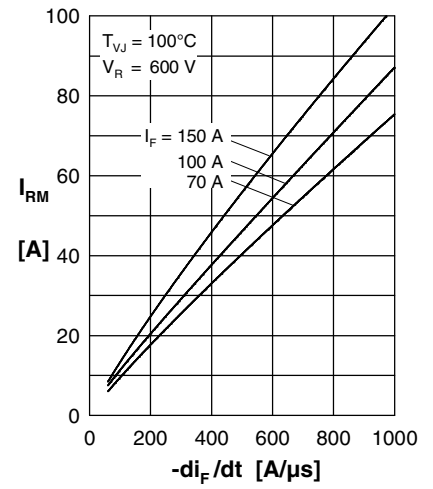
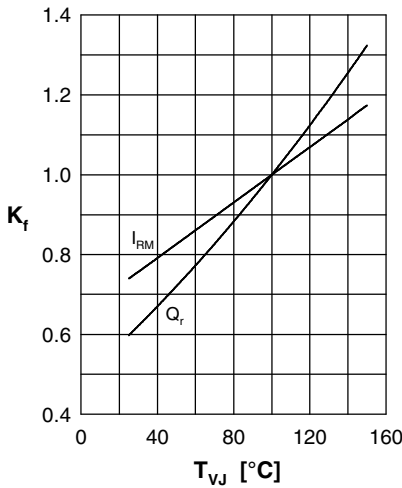
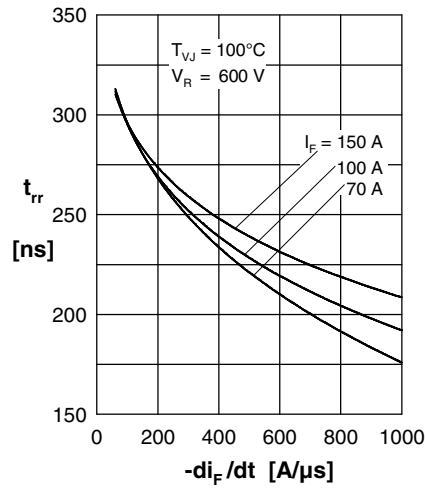
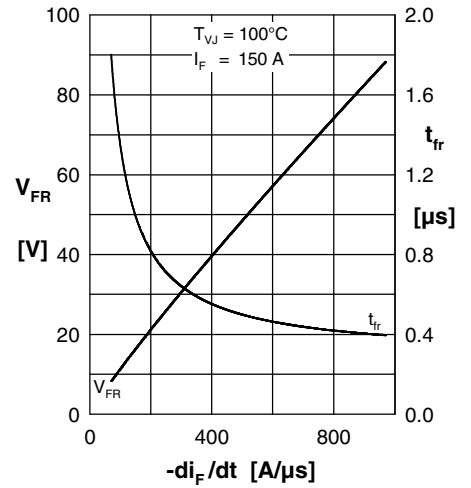
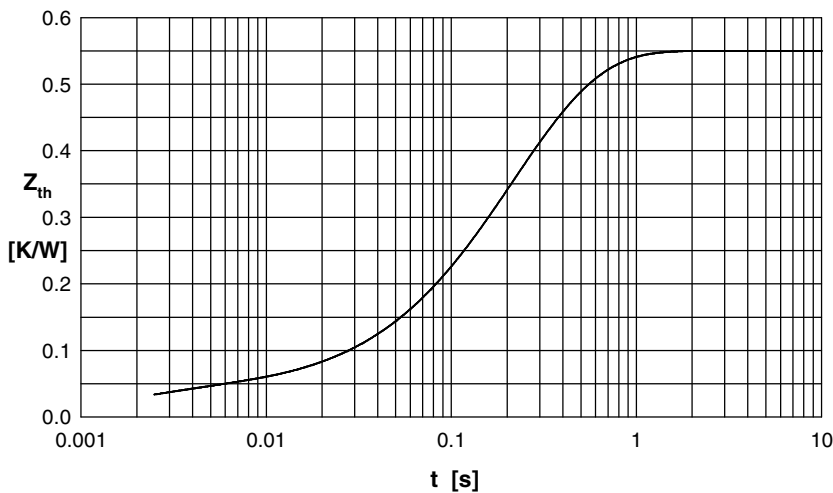
 Fig. 5 Typ. recovery time t_{rr} versus $-di_F/dt$

 Fig. 6 Typ. peak forward voltage V_{FR} and t_{fr} versus $-di_F/dt$

Fig. 7 Typ. transient thermal impedance junction to heatsink

 Constants for Z_{thJS} calculation:

i	R_{thi} (K/W)	t_i (s)
1	0.037	0.002
2	0.138	0.134
3	0.093	0.250
4	0.282	0.274