

FRED Module

Fast Recovery Epitaxial Diode

Single Diode

$$V_{RRM} = 1200 \text{ V}$$

$$I_{FAVM} = 453 \text{ A}$$

$$t_{rr} = 500 \text{ ns}$$

Part number

MEO 450-12DA



 E72873

Backside: isolated

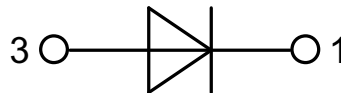

Features / Advantages:

- International standard package with DCB ceramic base plate
- Planar passivated chips
- Short recovery time
- Low switching losses
- Soft recovery behaviour
- High reliability circuit operation
- Low voltage peaks for reduced protection circuits
- Low noise switching
- Low losses

Applications:

- Antiparallel diode for high frequency switching devices
- Free wheeling diode in converters and motor control circuits
- Inductive heating and melting
- Uninterruptible power supplies (UPS)
- Ultrasonic cleaners and welders

Package: Y4-M6

- Isolation voltage: 3600 V~
- Industry standard outline
- Soldering pins for PCB mounting
- Base plate: DCB ceramic
- Reduced weight
- Advanced power cycling

Disclaimer Notice

Information furnished is believed to be accurate and reliable. However, users should independently evaluate the suitability of and test each product selected for their own applications. Littelfuse products are not designed for, and may not be used in, all applications. Read complete Disclaimer Notice at www.littelfuse.com/disclaimer-electronics.



Diode				Ratings			
Symbol	Definitions	Conditions	min.	typ.	max.		
V_{RSM}	max. non-repetitive reverse				1200	V	
V_{RRM}	max. repetitive reverse				1200	V	
I_R	reverse current	$V_R = V_{RRM}$ $V_R = 0.8 \cdot V_{RRM}$ $V_R = 0.8 \cdot V_{RRM}$	$T_{VJ} = 25^\circ\text{C}$		24	mA	
			$T_{VJ} = 25^\circ\text{C}$		6	mA	
			$T_{VJ} = 125^\circ\text{C}$		120	mA	
V_F	forward voltage	$I_F = 300\text{ A}$	$T_{VJ} = 25^\circ\text{C}$		1.78	V	
			$T_{VJ} = 125^\circ\text{C}$		1.51	V	
		$I_F = 520\text{ A}$	$T_{VJ} = 25^\circ\text{C}$		1.96	V	
			$T_{VJ} = 125^\circ\text{C}$		1.76	V	
I_{FRMS}	RMS forward current		$T_C = 75^\circ\text{C}$		640	A	
I_{FAV} ①	average forward current	$T_C = 75^\circ\text{C}$ rectangular, d = 0.5	$T_{VJ} = 150^\circ\text{C}$		453	A	
V_{TO}	threshold voltage	for power-loss calculations only	$T_{VJ} = T_{VJM}$		1.16	V	
r_T	slope resistance				1.15	mΩ	
R_{thJC}	thermal resistance junction to case			0.043	0.071	K/W	
R_{thCH}	thermal resistance junction to heatsink					K/W	
P_{tot}	total power dissipation		$T_{VJ} = 25^\circ\text{C}$		1750	W	
I_{FSM}	max. surge forward current	t = 10 ms (50 Hz), sine t = 8.3 ms (60 Hz), sine	$T_{VJ} = 45^\circ\text{C}$		4.80	kA	
					5.28	kA	
			$T_{VJ} = 150^\circ\text{C}$		4.32	kA	
					4.75	kA	
I^2t	I^2t value for fusing	t = 10 ms (50 Hz), sine t = 8.3 ms (60 Hz), sine	$T_{VJ} = 45^\circ\text{C}$		115.2	kA ² s	
					117.1	kA ² s	
			$T_{VJ} = 150^\circ\text{C}$		93.3	kA ² s	
					94.8	kA ² s	
t_{rr}	max. reverse recovery current	$I_F = 450\text{ A}; -di_F/dt = 800\text{ A}/\mu\text{s}$	$T_{VJ} = 25^\circ\text{C}$	250	300	ns	
			$T_{VJ} = 100^\circ\text{C}$	500	600	ns	
I_{RM}	reverse recovery time	$V_R = 600\text{ V}; L \leq 0.05\ \mu\text{H}$	$T_{VJ} = 25^\circ\text{C}$	80	100	A	
			$T_{VJ} = 100^\circ\text{C}$	125	150	A	

① I_{FAVM} rating includes reverse blocking losses at T_{VJM} , $V_R = 0.8 V_{RRM}$, duty cycle d = 0.5



Package Y4-M6				Ratings		
Symbol	Definitions	Conditions	min.	typ.	max.	
I_{RMS}	RMS current	per terminal			300	A
T_{VJ}	virtual junction temperature		-40		150	°C
T_{op}	operation temperature		-40		125	°C
T_{stg}	storage temperature		-40		125	°C
Weight					108	g
M_D	mounting torque		2.25		2.75	Nm
M_T	terminal torque		4.5		5.5	Nm
$d_{Spp/App}$	creepage distance on surface striking distance through air	terminal to terminal	14.0	10.0		mm
$d_{Spb/Appb}$		terminal to backside	16.0	16.0		mm
V_{ISOL}	isolation voltage	t = 1 second t = 1 minute	50/60 Hz, RMS; $I_{ISOL} \leq 1$ mA		3600 3000	V V

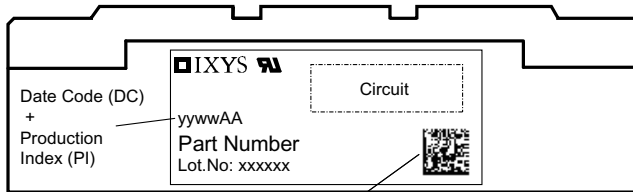

Data Matrix: part no. (1-19), DC + PI (20-25), lot.no.# (26-31), blank (32), serial no.# (33-36)

Ordering	Ordering Number	Marking on Product	Delivery Mode	Quantity	Code No.
Standard	MEO 450-12DA	MEO 450-12DA	Box	6	464635

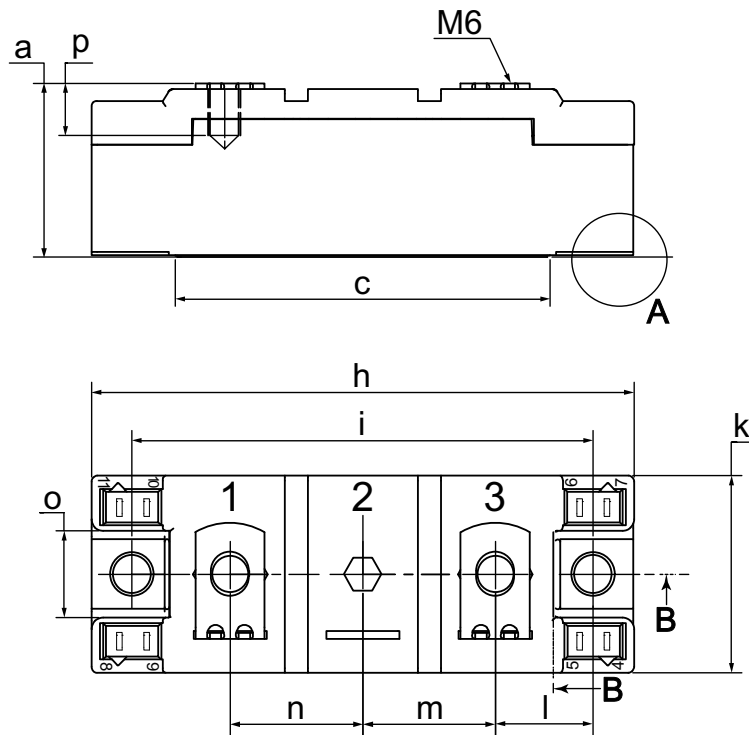
Outlines Y4-M6

Dim.	MIN [mm]	MAX [mm]	MIN [inch]	MAX [inch]
a	30.0	30.6	1.181	1.205
b	typ. 0.25		typ. 0.010	
c	64.0	65.0	2.520	2.559
d	6.5	7.0	0.256	0.275
e	4.9	5.1	0.193	0.201
h	93.5	94.5	3.681	3.720
i	79.5	80.5	3.130	3.169
k	33.4	34.0	1.315	1.339
l	16.7	17.3	0.657	0.681
m	22.7	23.3	0.894	0.917
n	22.7	23.3	0.894	0.917
o	14.0	15.0	0.551	0.591
p	typ. 10.5		typ. 0.413	

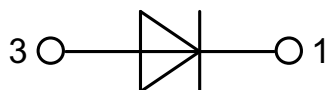
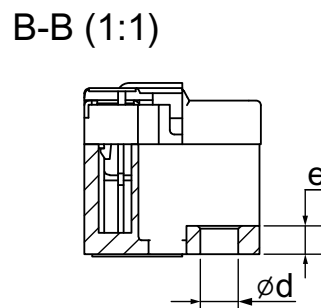
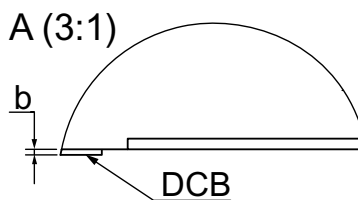

Curves

 Fig. 1 Typ. forward current I_F vs. V_F

 Fig. 2 Typ. reverse recovery charge Q_r versus $-di_F/dt$

 Fig. 3 Typ. peak reverse current I_{RM} versus $-di_F/dt$

 Fig. 4 Typ. dynamic parameters Q_r , I_{RM} versus T_{VJ}

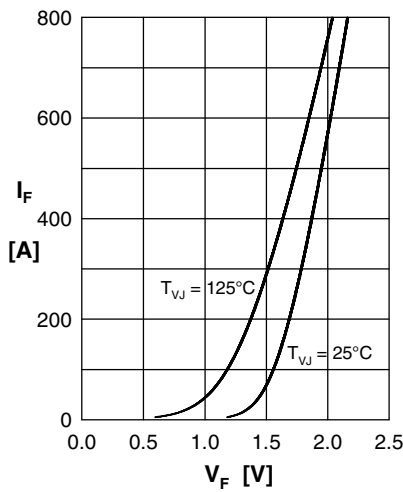
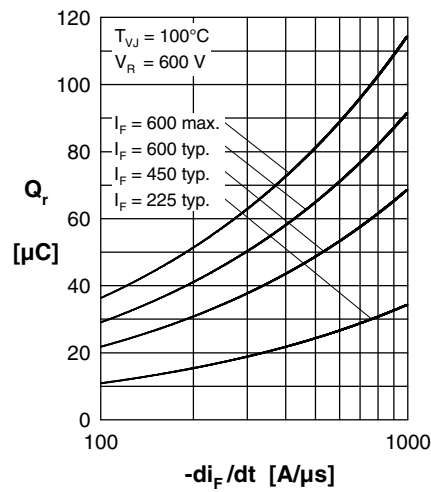
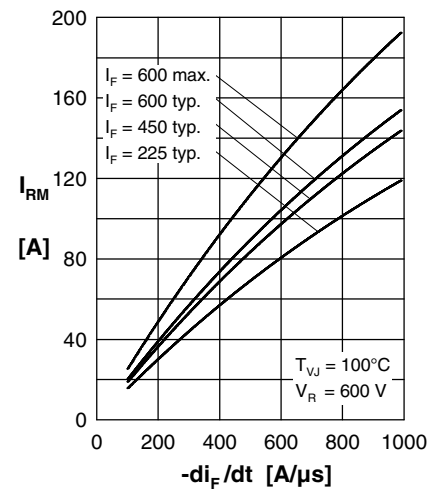
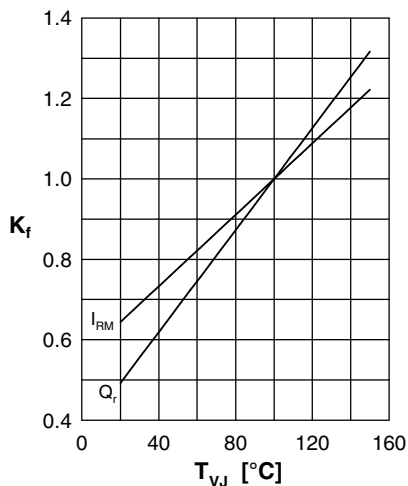
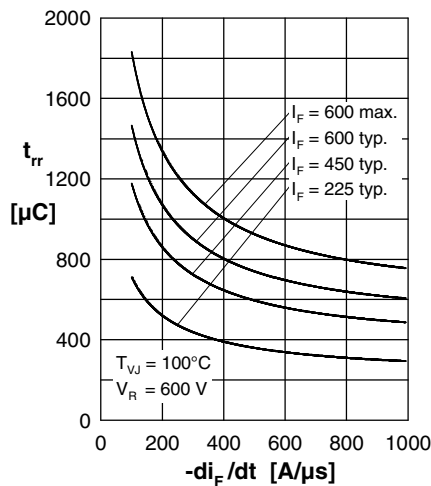
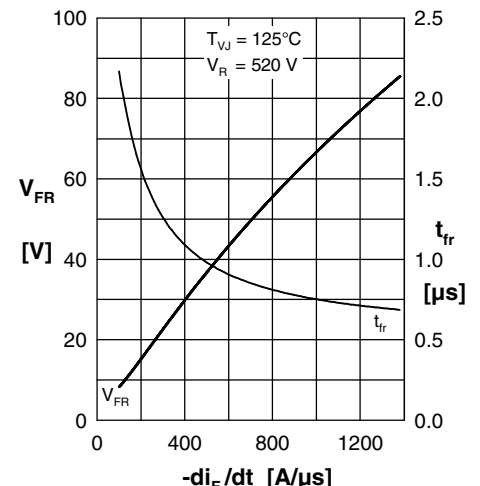
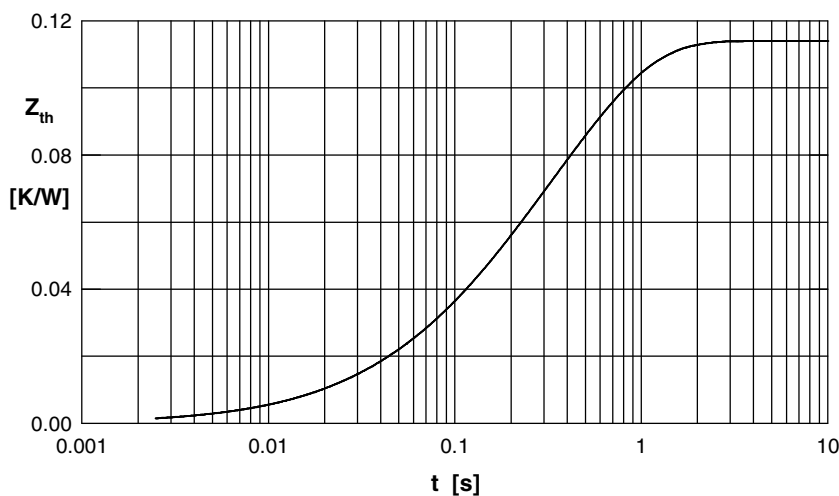
 Fig. 5 Typ. recovery time t_{rr} vs. $-di_F/dt$

 Fig. 6 Typ. peak forward voltage V_{FR} and t_{fr} versus T_{VJ}

Fig. 7 Typ. transient thermal impedance junction to case

 Constants for Z_{thJS} calculation:

i	R_{thi} (K/W)	t_i (s)
1	0.001	0.08
2	0.004	0.024
3	0.027	0.112
4	0.082	0.464