

# Six-Pack XPT IGBT

$$V_{CES} = 1200 \text{ V}$$

$$I_{C25} = 155 \text{ A}$$

$$V_{CE(sat)} = 1.8 \text{ V}$$

**Part name** (Marking on product)

MIXA100W1200TEH

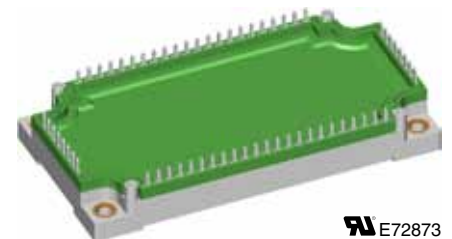
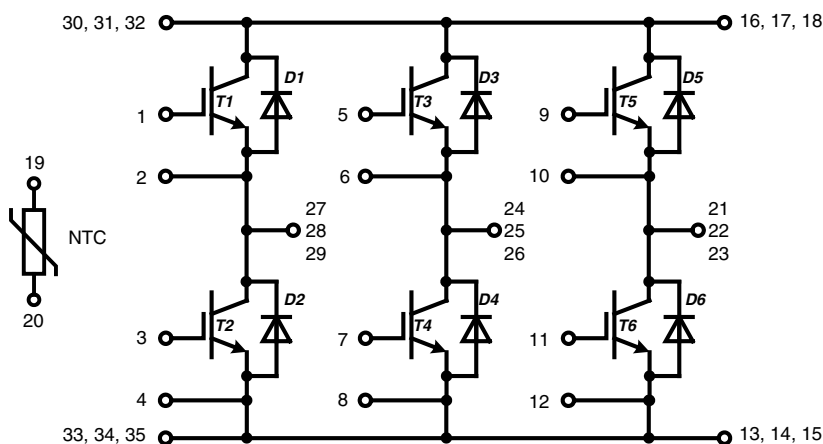

Pin configuration see outlines.

### Features:

- Easy paralleling due to the positive temperature coefficient of the on-state voltage
- Rugged XPT design (Xtreme light Punch Through) results in:
  - short circuit rated for 10  $\mu$ sec.
  - very low gate charge
  - square RBSOA @ 3x  $I_C$
  - low EMI
- Thin wafer technology combined with the XPT design results in a competitive low  $V_{CE(sat)}$
- SONIC™ diode
  - fast and soft reverse recovery
  - low operating forward voltage

### Application:

- AC motor drives
- Solar inverter
- Medical equipment
- Uninterruptible power supply
- Air-conditioning systems
- Welding equipment
- Switched-mode and resonant-mode power supplies

### Package:

- "E3-Pack" standard outline
- Insulated copper base plate
- Soldering pins for PCB mounting
- Temperature sense included
- Optimizes pin layout

**Output Inverter T1 - T6**

| Symbol        | Definitions                           | Conditions   | Ratings   |             |          | Unit          |   |
|---------------|---------------------------------------|--|---|-------------|----------|---------------|---|
|               |                                       |  | min.  | typ.        | max.     |               |   |
| $V_{CES}$     | collector emitter voltage             |  | $T_{VJ} = 25^{\circ}\text{C}$                                   |             | 1200     | V             |   |
| $V_{GES}$     | max. DC gate voltage                  | continuous   |   |             | $\pm 20$ | V             |   |
| $V_{GEM}$     | max. transient collector gate voltage | transient  |   |             | $\pm 30$ | V             |   |
| $I_{C25}$     | collector current                     |  | $T_C = 25^{\circ}\text{C}$                                      |             | 155      | A             |   |
| $I_{C80}$     |                                       |  | $T_C = 80^{\circ}\text{C}$                                      |             | 108      | A             |   |
| $P_{tot}$     | total power dissipation               |  | $T_C = 25^{\circ}\text{C}$                                      |             | 500      | W             |   |
| $V_{CE(sat)}$ | collector emitter saturation voltage  | $I_C = 100\text{ A}; V_{GE} = 15\text{ V}$   | $T_{VJ} = 25^{\circ}\text{C}$<br>$T_{VJ} = 125^{\circ}\text{C}$ | 1.8<br>2.1  | 2.1      | V<br>V        |   |
| $V_{GE(th)}$  | gate emitter threshold voltage        | $I_C = 4\text{ mA}; V_{GE} = V_{CE}$   | $T_{VJ} = 25^{\circ}\text{C}$                                   | 5.4         | 6.0      | 6.5           | V |
| $I_{CES}$     | collector emitter leakage current     | $V_{CE} = V_{CES}; V_{GE} = 0\text{ V}$  | $T_{VJ} = 25^{\circ}\text{C}$<br>$T_{VJ} = 125^{\circ}\text{C}$ | 0.03<br>0.6 | 0.3      | mA<br>mA      |   |
| $I_{GES}$     | gate emitter leakage current          | $V_{GE} = \pm 20\text{ V}$   |   |             | 500      | nA            |   |
| $Q_{G(on)}$   | total gate charge                     | $V_{CE} = 600\text{ V}; V_{GE} = 15\text{ V}; I_C = 100\text{ A}$  |   |             | 295      | nC            |   |
| $t_{d(on)}$   | turn-on delay time                    | inductive load<br>$V_{CE} = 600\text{ V}; I_C = 100\text{ A}$<br>$V_{GE} = \pm 15\text{ V}; R_G = 7\ \Omega$ | $T_{VJ} = 125^{\circ}\text{C}$                                  | 70          |          | ns            |   |
| $t_r$         | current rise time                     |  |   | 40          |          | ns            |   |
| $t_{d(off)}$  | turn-off delay time                   |  |   | 250         |          | ns            |   |
| $t_f$         | current fall time                     |  |   | 100         |          | ns            |   |
| $E_{on}$      | turn-on energy per pulse              |  |   | 8.5         |          | mJ            |   |
| $E_{off}$     | turn-off energy per pulse             |  |   | 11          |          | mJ            |   |
| <b>RBSOA</b>  | reverse bias safe operating area      | $V_{GE} = \pm 15\text{ V}; R_G = 7\ \Omega;$   | $T_{VJ} = 125^{\circ}\text{C}$<br>$V_{CEK} = 1200\text{ V}$     |             | 300      | A             |   |
| <b>SCSOA</b>  | short circuit safe operating area     |  | $T_{VJ} = 125^{\circ}\text{C}$                                  |             | 10       | $\mu\text{s}$ |   |
| $t_{SC}$      | short circuit duration                | $V_{CE} = 900\text{ V}; V_{GE} = \pm 15\text{ V};$<br>$R_G = 7\ \Omega;$ non-repetitive                      |   | 400         |          | A             |   |
| $I_{SC}$      | short circuit current                 |  |   |             |          |               |   |
| $R_{thJC}$    | thermal resistance junction to case   | (per IGBT)   |   |             | 0.25     | K/W           |   |

**Output Inverter D1 - D6**

| Symbol     | Definitions                         | Conditions  | Ratings   |              |      | Unit          |
|------------|-------------------------------------|---|---|--------------|------|---------------|
|            |                                     |   | min.  | typ.         | max. |               |
| $V_{RRM}$  | max. repetitive reverse voltage     |   | $T_{VJ} = 25^{\circ}\text{C}$                                   |              | 1200 | V             |
| $I_{F25}$  | forward current                     |   | $T_C = 25^{\circ}\text{C}$                                      |              | 135  | A             |
| $I_{F80}$  |                                     |   | $T_C = 80^{\circ}\text{C}$                                      |              | 90   | A             |
| $V_F$      | forward voltage                     | $I_F = 100\text{ A}; V_{GE} = 0\text{ V}$   | $T_{VJ} = 25^{\circ}\text{C}$<br>$T_{VJ} = 125^{\circ}\text{C}$ | 1.95<br>1.95 | 2.2  | V<br>V        |
| $Q_{rr}$   | reverse recovery charge             | $V_R = 600\text{ V}$<br>$di_f/dt = -1600\text{ A}/\mu\text{s}$<br>$I_F = 100\text{ A}; V_{GE} = 0\text{ V}$ | $T_{VJ} = 125^{\circ}\text{C}$                                  | 12.5         |      | $\mu\text{C}$ |
| $I_{RM}$   | max. reverse recovery current       |   |   | 100          |      | A             |
| $t_{rr}$   | reverse recovery time               |   |   | 350          |      | ns            |
| $E_{rec}$  | reverse recovery energy             |   |   | 4            |      | mJ            |
| $R_{thJC}$ | thermal resistance junction to case | (per diode)   |   |              | 0.4  | K/W           |

 $T_C = 25^{\circ}\text{C}$  unless otherwise stated

**Temperature Sensor NTC**

| Symbol      | Definitions | Conditions               | Ratings |      |      | Unit       |
|-------------|-------------|--------------------------|---------|------|------|------------|
|             |             |                          | min.    | typ. | max. |            |
| $R_{25}$    | resistance  | $T_C = 25^\circ\text{C}$ | 4.75    | 5.0  | 5.25 | k $\Omega$ |
| $B_{25/50}$ |             |                          |         | 3375 |      | K          |

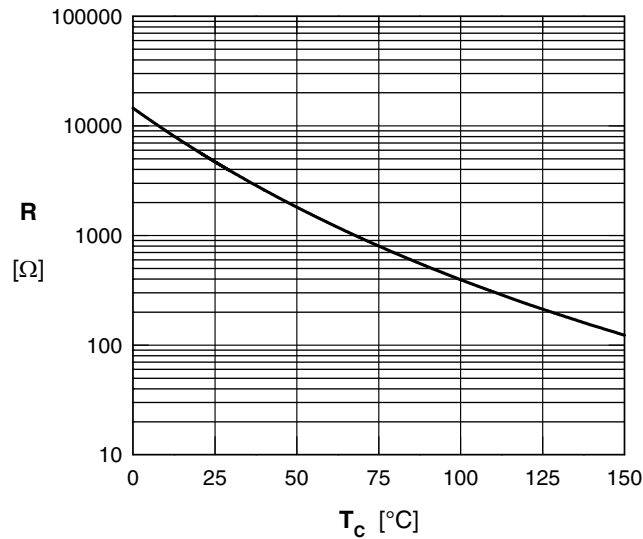

Typ. NTC resistance vs. temperature

**Module**

| Symbol         | Definitions                         | Conditions                                     | Ratings |      |      | Unit             |
|----------------|-------------------------------------|--|---------|------|------|------------------|
|                |                                     |  | min.    | typ. | max. |                  |
| $T_{VJ}$       | operating temperature               |  | -40     |      | 125  | $^\circ\text{C}$ |
| $T_{VJM}$      | max. virtual junction temperature   |  |         |      | 150  | $^\circ\text{C}$ |
| $T_{stg}$      | storage temperature                 |  | -40     |      | 125  | $^\circ\text{C}$ |
| $V_{ISOL}$     | isolation voltage                   | $I_{ISOL} \leq 1 \text{ mA}; 50/60 \text{ Hz}$ |         |      | 3000 | V~               |
| CTI            | comparative tracking index          |  |         |      | 200  |                  |
| $M_d$          | mounting torque (M5)                |  | 3       |      | 6    | Nm               |
| $d_s$          | creep distance on surface           |  | 10      |      |      | mm               |
| $d_A$          | strike distance through air         |  | 7.5     |      |      | mm               |
| $R_{pin-chip}$ | resistance pin to chip              |  |         | 2.5  |      | m $\Omega$       |
| $R_{thCH}$     | thermal resistance case to heatsink | with heatsink compound                         |         | 0.02 |      | K/W              |
| <b>Weight</b>  |                                     |  |         | 300  |      | g                |

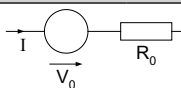
**Equivalent Circuits for Simulation**

| Symbol | Definitions         | Conditions | Ratings                      |      |      | Unit       |
|--------|---------------------|------------|------------------------------|------|------|------------|
|        |                     |            | min.                         | typ. | max. |            |
| $V_0$  | IGBT                | T1 - T6    | $T_{VJ} = 150^\circ\text{C}$ |      | 1.1  | V          |
| $R_0$  |                     |            |                              |      | 13.8 | m $\Omega$ |
| $V_0$  | free wheeling diode | D1 - D6    | $T_{VJ} = 150^\circ\text{C}$ |      | 1.25 | V          |
| $R_0$  |                     |            |                              |      | 8.5  | m $\Omega$ |

 $T_C = 25^\circ\text{C}$  unless otherwise stated

### Circuit Diagram

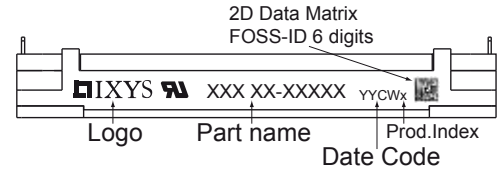
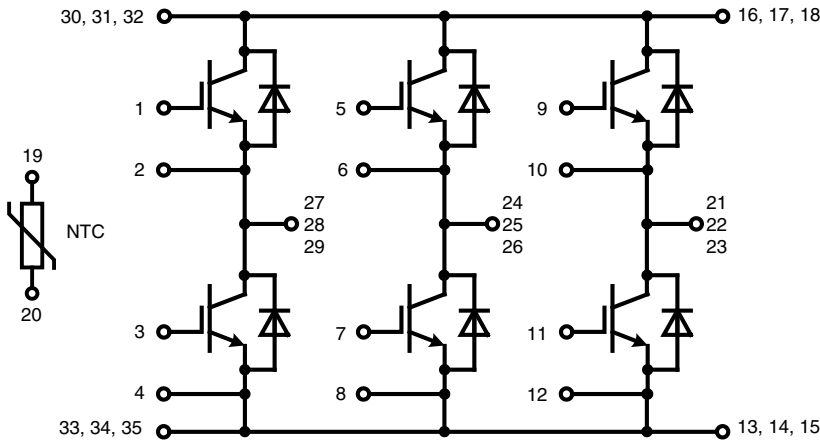

#### Part number

- M = Module
- I = IGBT
- X = XPT
- A = standard
- 100 = Current Rating [A]
- W = Six-Pack
- 1200 = Reverse Voltage [V]
- T = NTC
- EH = E3-Pack

### Outline Drawing

Dimensions in mm (1 mm = 0.0394")

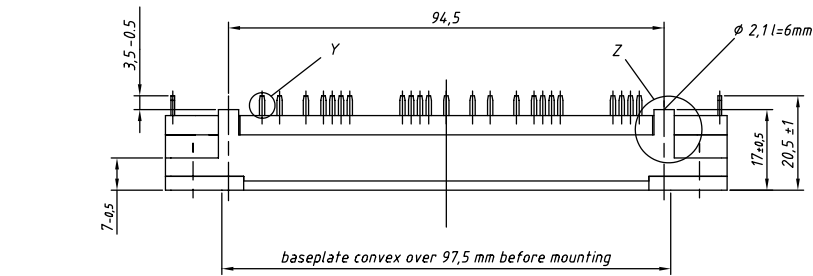

#### Detail X

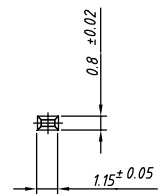

#### Detail Y

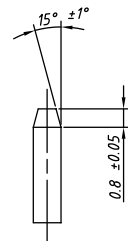

#### Detail Z

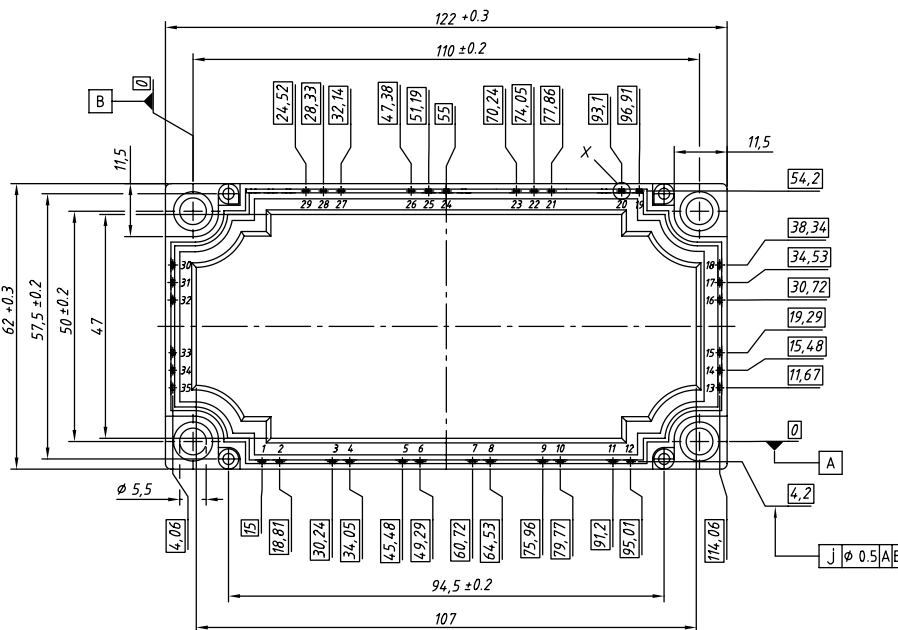
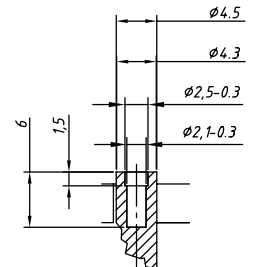

### Product Marking

| Ordering | Part Name        | Marking on Product | Delivering Mode | Base Qty | Ordering Code |
|----------|------------------|--------------------|-----------------|----------|---------------|
| Standard | MIXA100W1200 TEH | MIXA100W1200TEH    | Box             | 5        | 510402        |

## Transistor T1 - T6

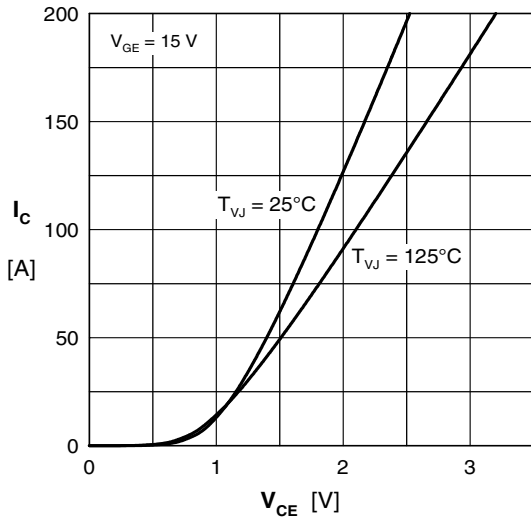

Fig. 1 Typ. output characteristics

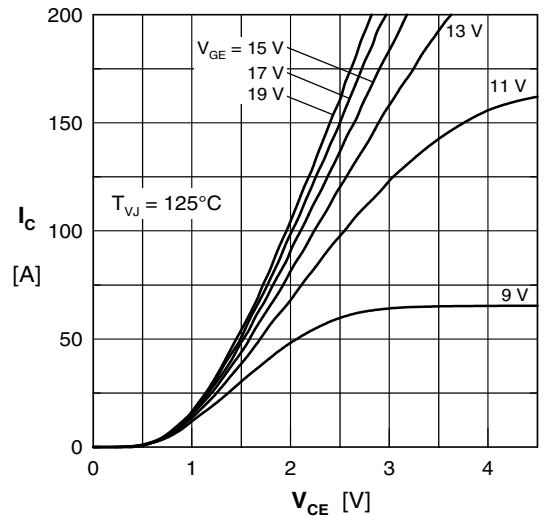

Fig. 2 Typ. output characteristics

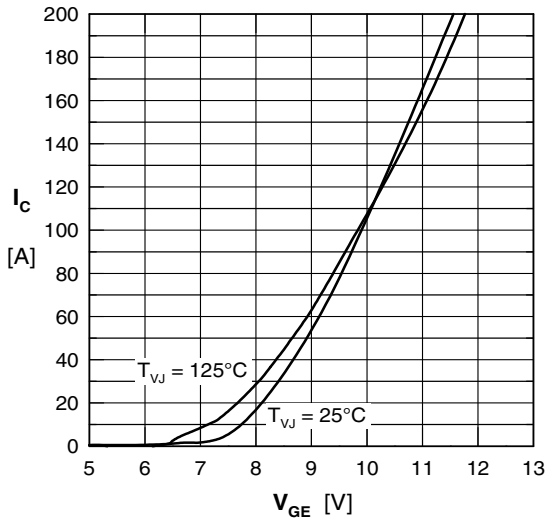

Fig. 3 Typ. transfer characteristics

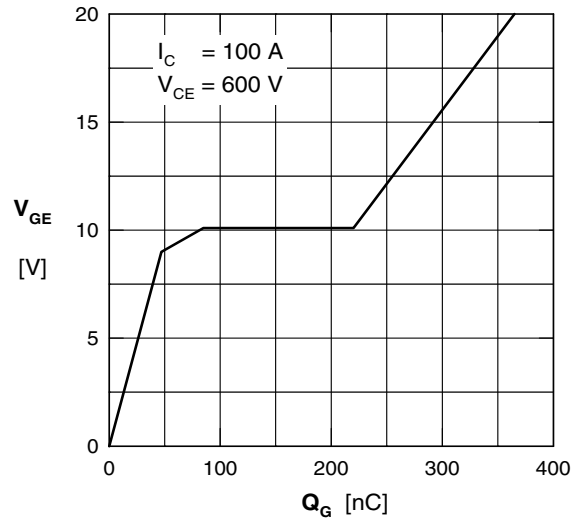

Fig. 4 Typ. turn-on gate charge

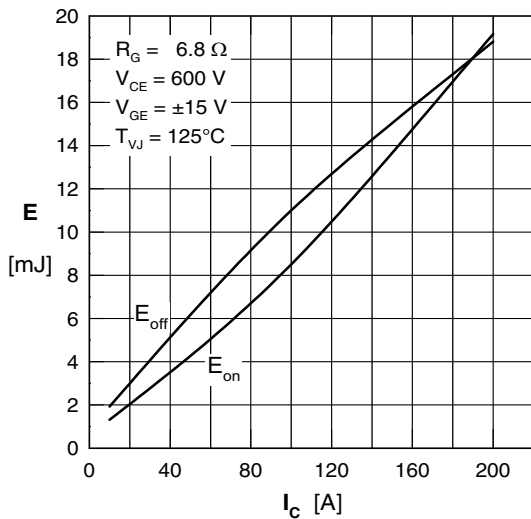

Fig. 5 Typ. switching energy vs. collector current

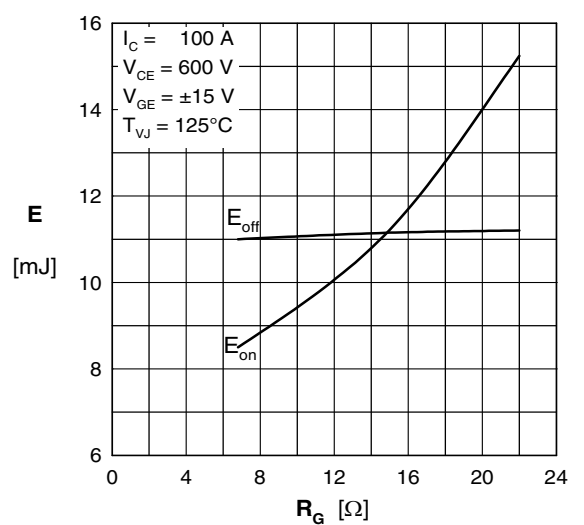

Fig. 6 Typ. switching energy vs. gate resistance

## Inverter D1 - D6

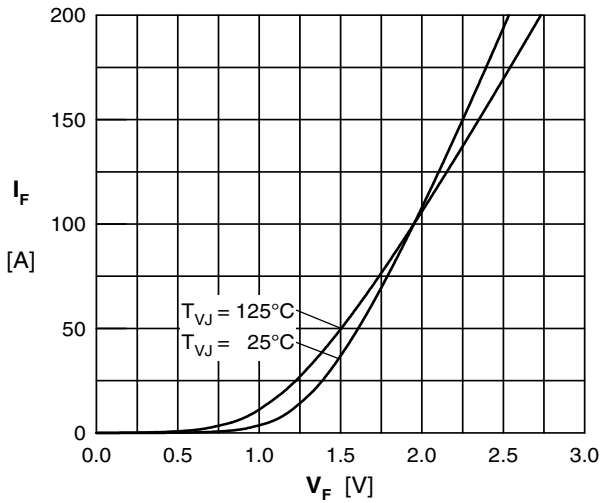

Fig. 7 Typ. Forward current versus  $V_F$

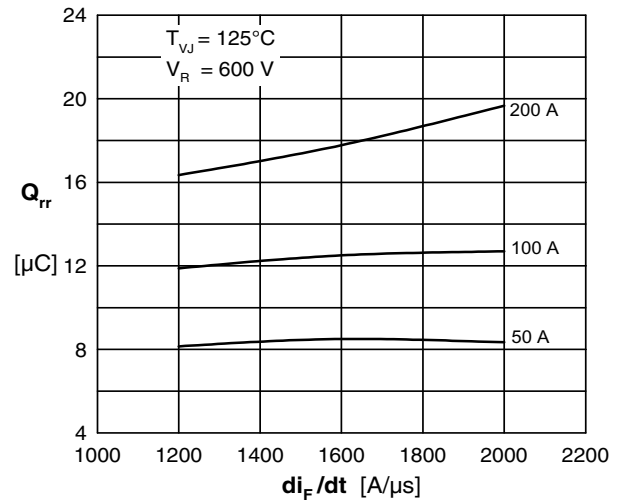

Fig. 8 Typ. reverse recov.charge  $Q_{rr}$  vs.  $di/dt$

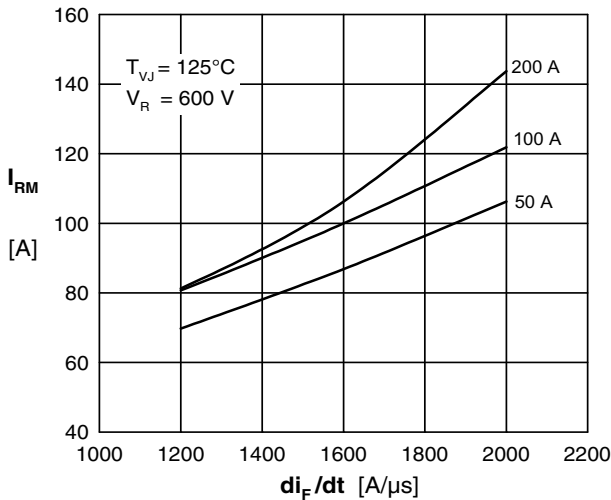

Fig. 9 Typ. peak reverse current  $I_{RM}$  vs.  $di/dt$

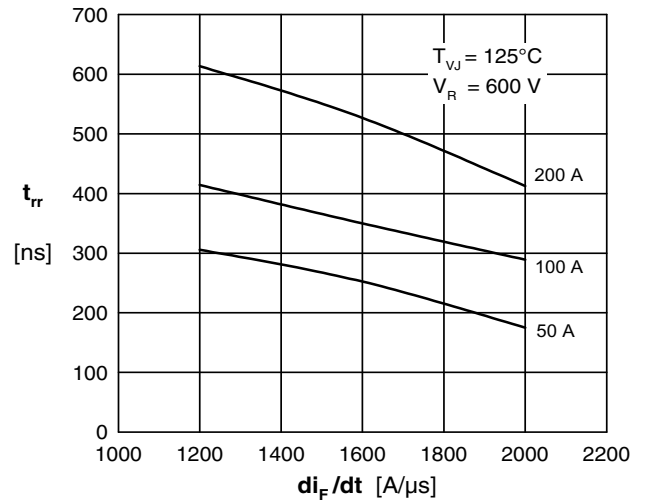

Fig. 10 Typ. recovery time  $t_{rr}$  versus  $di/dt$

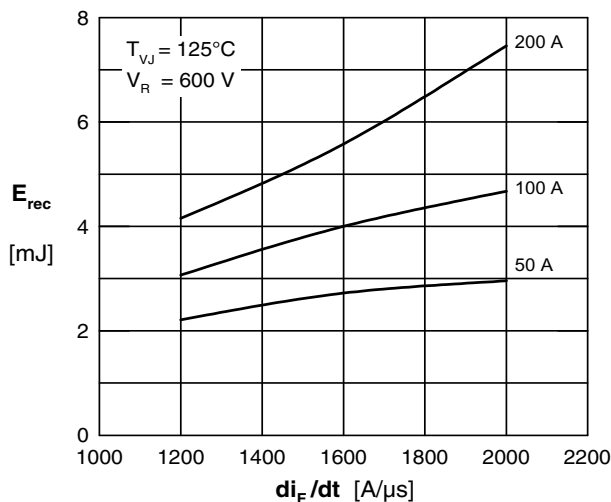

Fig. 11 Typ. recovery energy  $E_{rec}$  versus  $di/dt$

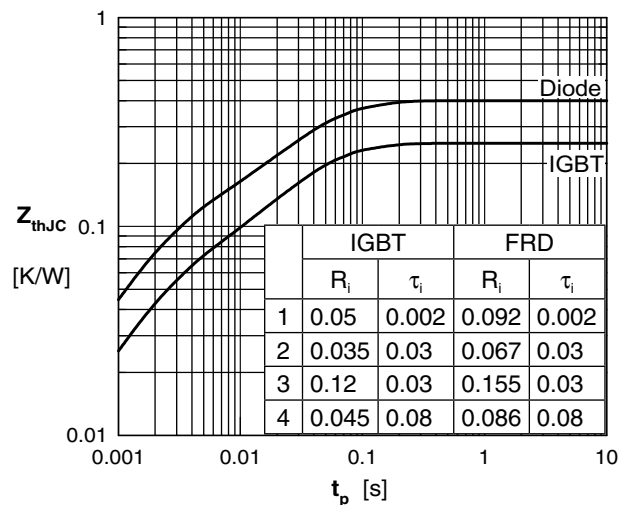

Fig. 12 Typ. transient thermal impedance