

X2PT IGBT Module

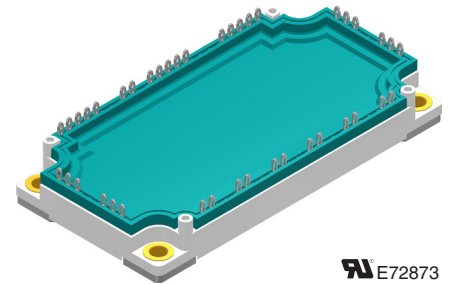
6-Pack + NTC + Shunt


advanced

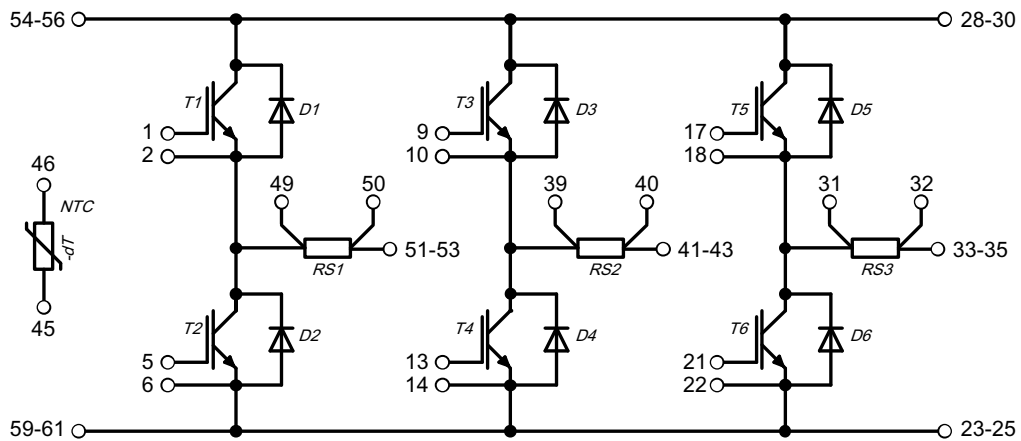
$V_{CES} = 1200\text{ V}$
 $I_{C25} = 312\text{ A}$
 $V_{CE(sat)} = 1.7\text{ V}$

Part number

MIXG240W1200PZTEH



 E72873



Features / Advantages:

- X2PT - 2nd generation Xtreme light Punch Through
- $T_{Vj,m} = 175^{\circ}\text{C}$
- Easy paralleling due to the positive temperature coefficient of the on-state voltage
- Rugged X2PT design results in:
 - short circuit rated for 10 μs .
 - very low gate charge
 - low EMI
 - square RBSOA @ $2x I_c$
- Low $V_{CE(sat)}$ and low thermal resistance
- SONIC2™ diode
 - fast and soft reverse recovery
 - low operating forward voltage

Applications:

- AC motor drives
- Solar inverter
- Medical equipment
- Uninterruptible power supply
- Air-conditioning systems
- Welding equipment
- Switched-mode and resonant-mode power supplies
- Inductive heating, cookers
- Pumps, Fans

Package: E3-Pack

- Isolation Voltage: 3600 V~
- Industry standard outline
- RoHS compliant
- Base plate: Copper internally DCB isolated
- Advanced power cycling
- PressFit pins

Option:

- Phase Change Material printed on base plate

Disclaimer Notice

Information furnished is believed to be accurate and reliable. However, users should independently evaluate the suitability of and test each product selected for their own applications. Littelfuse products are not designed for, and may not be used in, all applications. Read complete Disclaimer Notice at www.littelfuse.com/disclaimer-electronics.



Inverter IGBT T1 - T6				Ratings		
Symbol	Definitions	Conditions	min.	typ.	max.	
V_{CES}	collector emitter voltage	$I_R = 500 \mu A$	$T_{VJ} = 25^\circ C$	1200		V
V_{GES}	max. DC gate voltage			-20	+20	V
V_{GEM}	max. transient gate emitter voltage			-30	+30	V
I_{C25}	collector current		$T_C = 25^\circ C$		312	A
I_{C80}			$T_C = 80^\circ C$		233	A
I_{C100}			$T_C = 100^\circ C$		200	A
P_{tot}	total power dissipation		$T_C = 25^\circ C$		938	W
$V_{CE(sat)}$	collector emitter saturation voltage on die level	$I_C = 200 A; V_{GE} = 15 V$	$T_{VJ} = 25^\circ C$ $T_{VJ} = 150^\circ C$	1.7 2	2	V V
$V_{GE(th)}$	gate emitter threshold voltage	$I_C = 8 mA; V_{GE} = V_{GE}$	$T_{VJ} = 25^\circ C$	6.0	7.5	V
I_{CES}	collector emitter leakage current (includes diode reverse current)	$V_{CE} = V_{CES}; V_{GE} = 0 V$	$T_{VJ} = 25^\circ C$ $T_{VJ} = 150^\circ C$	2	0.15	mA mA
I_{GES}	gate emitter leakage current	$V_{GE} = \pm 20 V$			500	nA
R_G	internal gate resistance			6.5		Ω
C_{iss}	input capacitance	} $V_{CE} = 100 V; V_{GS} = 0 V; f = 1 MHz$		10.6		nF
C_{oss}	output capacitance					pF
C_{rss}	reverse transfer (Miller) capacitance					pF
Q_g	total gate charge	} $V_{CE} = 600 V; V_{GE} = 0 / 15 V; I_C = 200 A$		630		nC
Q_{gs}	gate source charge					nC
Q_{gd}	gate drain (Miller) charge					nC
$t_{d(on)}$	turn-on delay time	} Inductive switching $V_{CE} = 680 V; I_C = 200 A$ $V_{GE} = \pm 15 V; R_G = 3.9 \Omega$ (external) $T_{VJ} = 25^\circ C$		170		ns
t_r	current rise time			55		ns
$t_{d(off)}$	turn-off delay time			290		ns
t_f	current fall time			120		ns
E_{on}	turn-on energy per pulse			17.1		mJ
E_{off}	turn-off energy per pulse			14.2		mJ
$E_{rec(off)}$	reverse recovery losses at turn-off			4.6		mJ
$t_{d(on)}$	turn-on delay time	} Inductive switching $V_{CE} = 680 V; I_C = 200 A$ $V_{GE} = \pm 15 V; R_G = 3.9 \Omega$ (external) $T_{VJ} = 150^\circ C$		180		ns
t_r	current rise time			70		ns
$t_{d(off)}$	turn-off delay time			360		ns
t_f	current fall time			215		ns
E_{on}	turn-on energy per pulse			23.5		mJ
E_{off}	turn-off energy per pulse			20.5		mJ
$E_{rec(off)}$	reverse recovery losses at turn-off			12.2		mJ
RBSOA	reverse bias safe operating area	} $V_{GE} = \pm 15 V; R_G = 3.9 \Omega$ $V_{CEmax} = 1200 V$	$T_{VJ} = 150^\circ C$		400	A
I_{CM}						
SCSOA	short circuit safe operating area	} $V_{CEmax} = 1200 V$ $V_{CE} = 900 V; V_{GE} = \pm 15 V$ non-repetitive	$T_{VJ} = 150^\circ C$		10	μs
t_{SC}	short circuit duration				900	A
I_{SC}	short circuit current					
R_{thJC}	thermal resistance junction to case	with heatsink compound; IXYS test setup		0.24	0.16	K/W
R_{thJH}	thermal resistance junction to heatsink					K/W

advanced

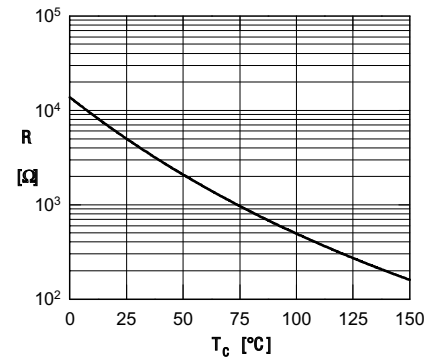
Inverter Diode D1 - D6				Ratings						
Symbol	Definitions	Conditions	min.	typ.	max.	Unit				
V_{RRM}	max. repetitive reverse voltage	$I_R = 500 \mu A$, see V_{CES}	$T_{VJ} = 25^\circ C$	1200		V				
I_{F25} I_{F80} I_{F100}	forward current		$T_C = 25^\circ C$ $T_C = 80^\circ C$ $T_C = 100^\circ C$		189 136 114	A				
V_F	forward voltage on die level	$I_F = 200 A$	$T_{VJ} = 25^\circ C$ $T_{VJ} = 150^\circ C$	1.87 1.85	2.2 2,2	V				
I_R	reverse current * not applicable, see I_{ces} at IGBT	$V_R = V_{RRM}$	$T_{VJ} = 25^\circ C$ $T_{VJ} = 150^\circ C$	*	*	mA mA				
Q_{RM} I_{RM} t_{tr} di/dt E_{rec}	reverse recovery charge max. reverse recovery current reverse recovery time rate of change of current reverse recovery energy	$V_{CE} = 600 V$; $I_C = 200 A$ $V_{GE} = \pm 15 V$; $R_G = 3.9 \Omega$ (external)	$T_{VJ} = 25^\circ C$		12 170 240 4200 4.6	μC A ns A/ μs mJ				
Q_{RM} I_{RM} t_{tr} di/dt E_{rec}	reverse recovery charge max. reverse recovery current reverse recovery time rate of change of current reverse recovery energy			$V_{CE} = 600 V$; $I_C = 200 A$ $V_{GE} = \pm 15 V$; $R_G = 3.9 \Omega$ (external)	$T_{VJ} = 150^\circ C$		26 195 480 3600 12.2	μC A ns A/ μs mJ		
R_{thJC} R_{thJH}	thermal resistance junction to case thermal resistance junction to heatsink					with heatsink compound; IXYS test setup		0.48	0.38	K/W K/W

Shunt Resistor				Ratings		
Symbol	Definitions	Conditions	min.	typ.	max.	Unit
R_{SHUNT}	resistance temperature coefficient		$T_C = 25^\circ C$	0.495	0.500 50	m Ω ppm/K
R_{thSH}	thermal resistance shunt to heatsink	with heatsink compound; IXYS test setup *		10		K/W

* Note: Continuous shunt temperature should not exceed 170°C

Temperature Sensor NTC						
Symbol	Definitions	Conditions	min.	typ.	max.	Unit
R_{25}	resistance	$T_{VJ} = 25^\circ C$	4.75	5.0	5.25	k Ω
$B_{25/50}$	temperature coefficient			3375		K

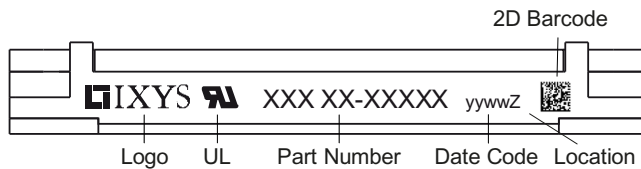
Equivalent Circuits for Simulation <small>*on die level</small>			
Symbol	Definitions	Conditions	Unit
V_0	threshold voltage	$T_{VJ} = 125^\circ C$	V
R_0	slope resistance *		m Ω
V_0	threshold voltage	$T_{VJ} = 175^\circ C$	V
R_0	slope resistance *		m Ω



Typ. NTC resistance vs. temperature

advanced

Package E3-Pack				Ratings		
Symbol	Definitions	Conditions	min.	typ.	max.	Unit
I_{RMS}	RMS current	per terminal			30	A
T_{stg}	storage temperature		-40		125	°C
T_{op}	operation temperature		-40		150	°C
T_{vJ}	virtual junction temperature		-40		175	°C
Weight					320	g
M_D	mounting torque		3		6	Nm
d_{Spp}	creepage distance on surface	terminal to terminal	6.0			mm
d_{Spb}		terminal to backside	12.0			mm
d_{App}	striking distance through air	terminal to terminal	6.0			mm
d_{Apb}		terminal to backside	12.0			mm
V_{ISOL}	isolation voltage	t = 1 second t = 1 minute	4300 3600			V V
$R_{pin-chip}$	resistance pin to chip	$V = V_{CEsat} + 2 \cdot R \cdot I_C$ resp. $V = V_F + 2 \cdot R \cdot I_F$				mΩ
C_p	coupling capacity per switch	between shorted pins of switch and back side metallization				pF

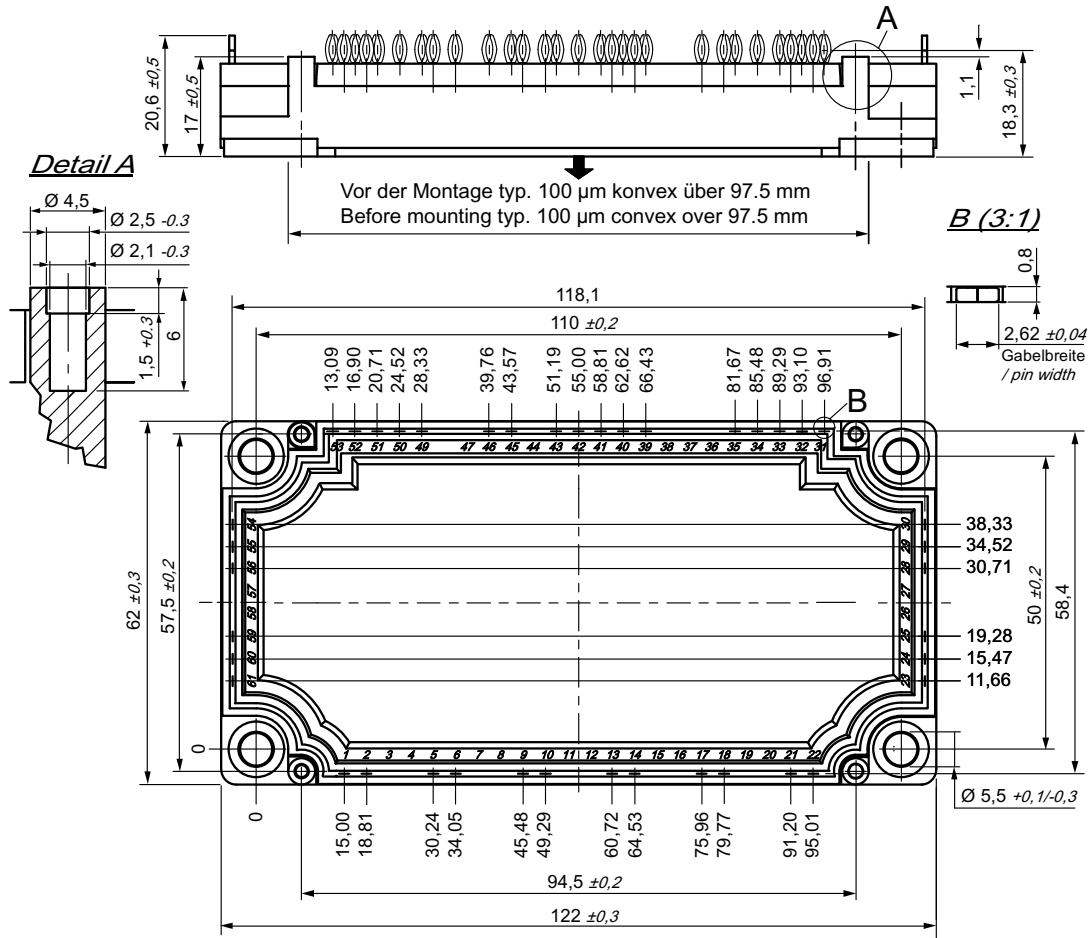

Part number

M = Module
 I = IGBT
 X = XPT IGBT
 G = Gen 2 / std
 240 = Current Rating [A]
 W = 6-pack
 1200 = Reverse Voltage [V]
 PZT = PressFit Pin + Shunt 0.5mΩ, Thermistor
 EH = E3-Pack

Ordering	Part Name	Marking on Product	Delivering Mode	Base Qty	Ordering Code
Standard	MIXG240W1200PZTEH	MIXG240W1200PZTEH	Blister	24	MIXG240W1200PZTEH
with Phase Change Material	MIXG240W1200PZTEH -PC ¹⁾	MIXG240W1200PZTEH	Blister	24	

Similar Part	Package	Voltage class
MIXG240W1200TEH	E3- Pack	1200
MIXG240W1200PTEH ²⁾	E3- Pack, press fit pin	1200

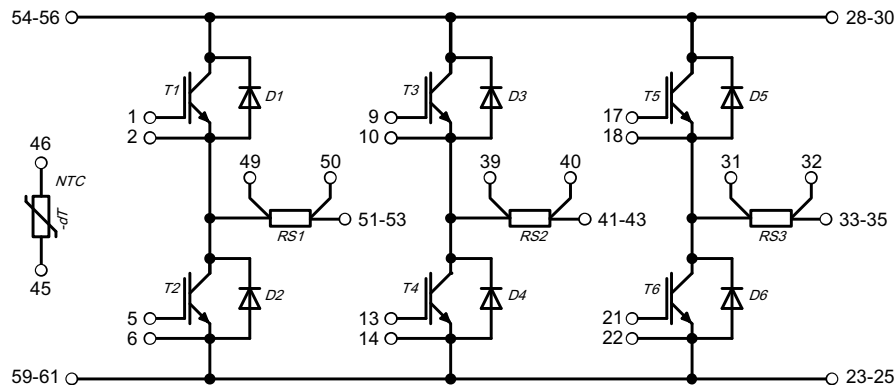
Options: ¹⁾ phase change material and ²⁾ press fit pin
 Please contact Littelfuse - IXYS sales office for availability

Outlines E3-Pack

Bemerkung / Note:

- Nichttolerierete Maße nach / Measure without tolerances according DIN ISO 2768-T1-m
- PCB-Lochmuster / PCB hole pattern: **see pin position**
- Toleranz Pin-Position und PCB-Lochmuster / Tolerance of pin position and PCB hole pattern: $\oplus 0.1$
- Bohrlochdurchmesser / Diameter of drill: **Ø 2.35 mm**
- Endlochdurchmesser / Diameter of plated holes: **Ø 2.14 - 2.29 mm** (Cu thickness in via typ. 50 µm)
- Beschichtung / Plating: **chem. Sn max. 15 µm**
- Einpresskraft / Insert Force: per terminal with a typ. insert speed of 7 mm/s: **typ. 90 N**
- Weitere Angaben / Further information: www.ixys.com **Application note IXAN0077**
- Montageanleitung / Mounting instruction: www.ixys.com **Application note IXAN0024**

Detail A: PCB-Montage / Mounting on PCB

- Empfohlene, selbstschneidende Schraube / Recommended, self-tapping screw: **EJOT PT®** (Größe / size: **K25**)
- Max. Schraubenlänge / Max. screw length: **PCB-Dicke / thickness + 6 mm** (max. Lochtiefe / hole depth)
- Empfohlenes Drehmoment / Recommended mounting torque: **1.5 Nm**



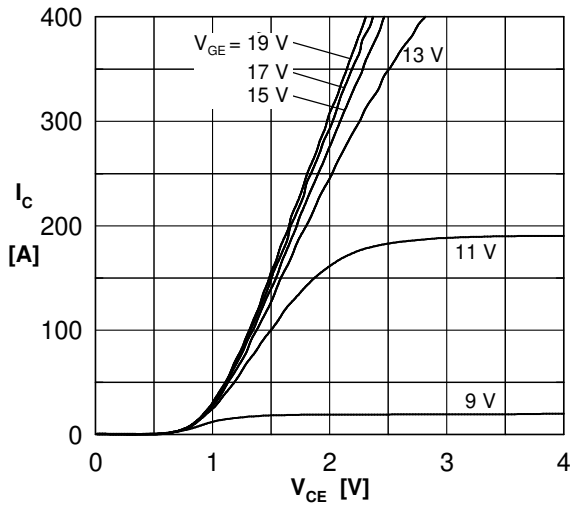
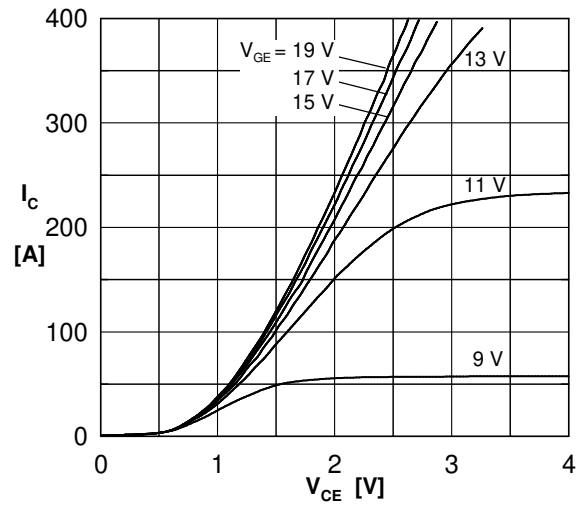
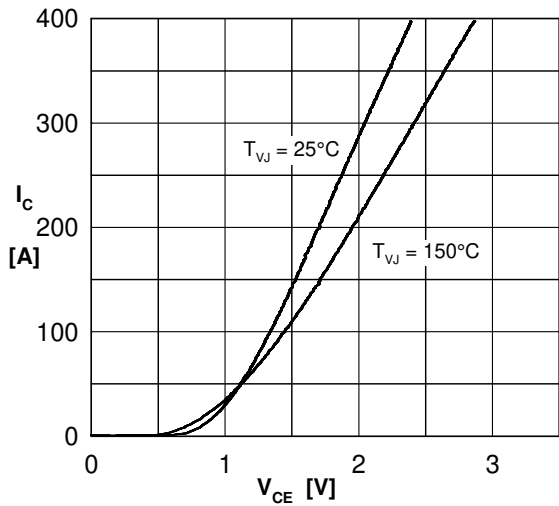
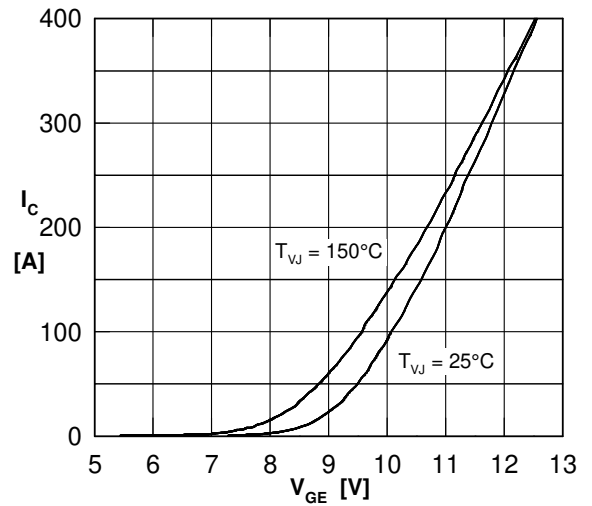
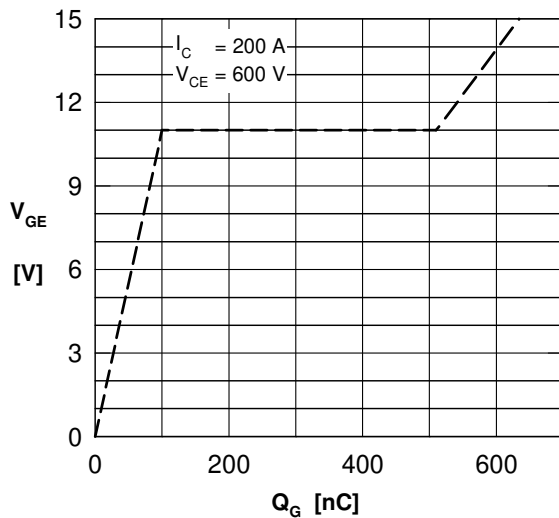
IGBT T1 - T6

 Fig. 1 Typ. output characteristics ($T_{VJ} = 25^{\circ}\text{C}$)

 Fig. 2 Typ. output characteristics ($T_{VJ} = 150^{\circ}\text{C}$)

 Fig. 3 Typ. output characteristics ($V_{GE} = 15\text{V}$)

 Fig. 4 Typ. transfer characteristics ($V_{CE} = 20\text{V}$)


Fig. 5 Typ. turn-on gate charge 0/15V

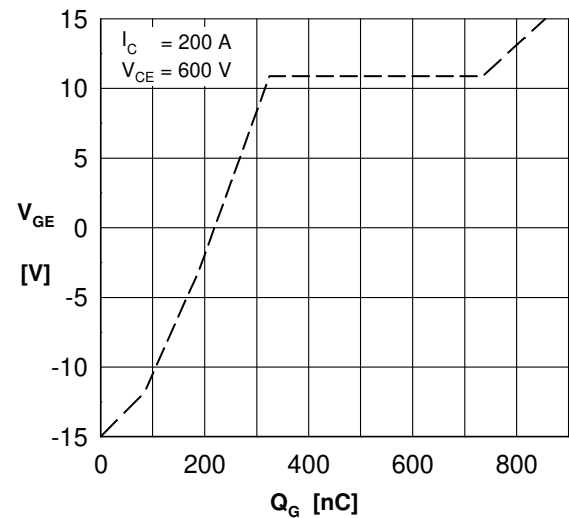


Fig. 6 Typ. turn-on gate charge -15/+15V

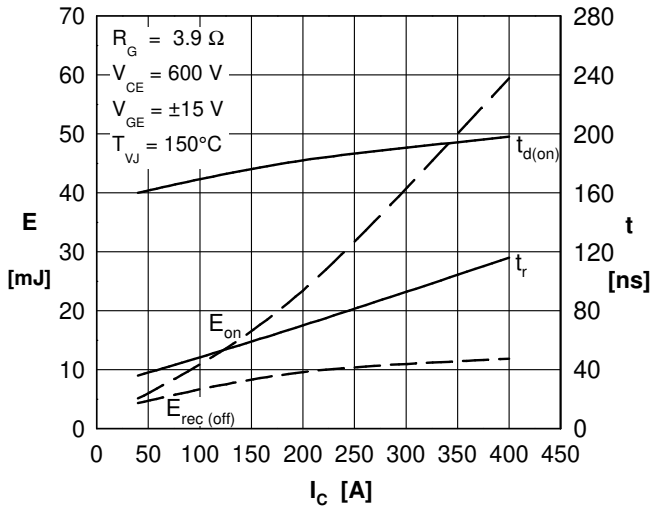
IGBT T1 - T6


Fig. 7 Typ. switching energy versus collector current (turn on)

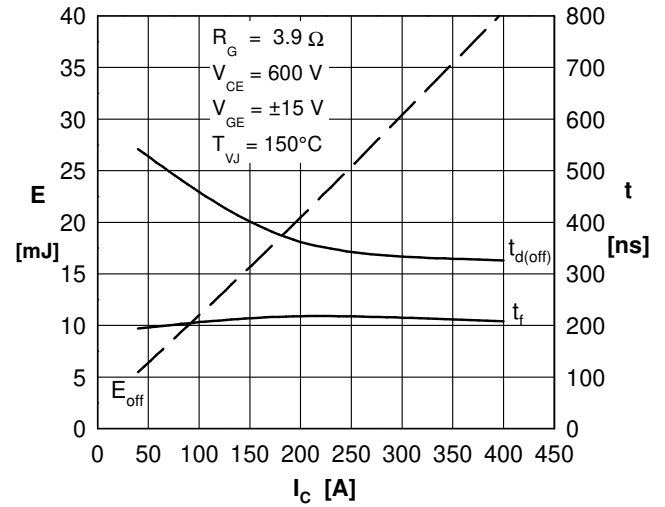


Fig. 8 Typ. switching energy versus collector current (turn off)

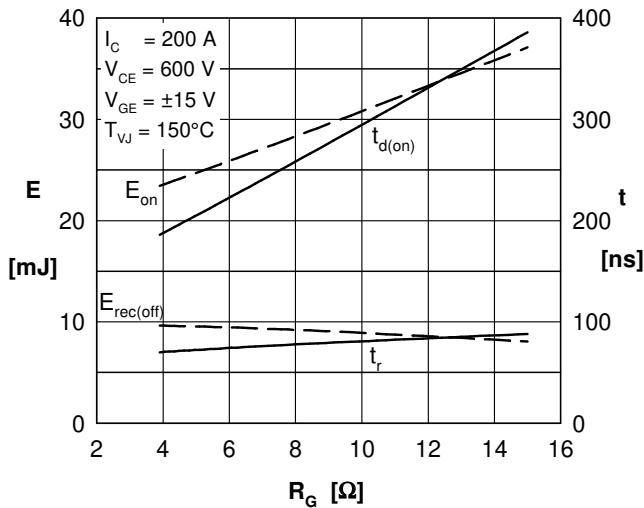


Fig. 9 Typ. switching energy versus gate resistor (turn on)

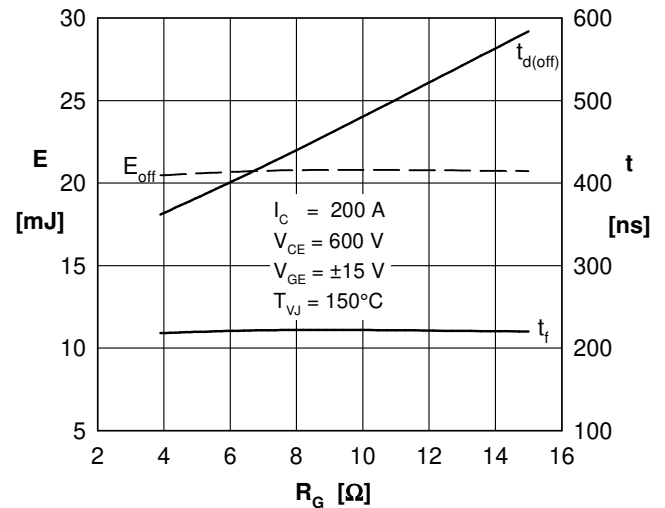


Fig. 10 Typ. switching energy versus gate resistor (turn off)

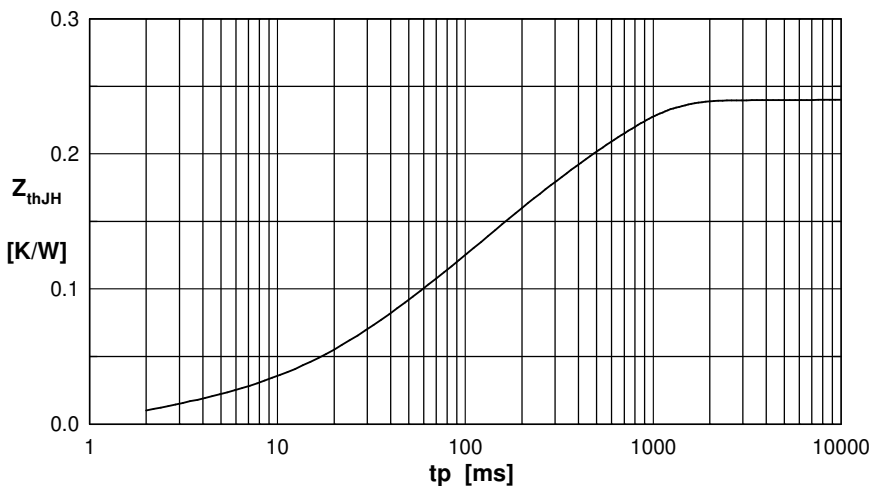


Fig. 11 IGBT: typ. transient thermal impedance to heat sink

DIODE D1 - D6

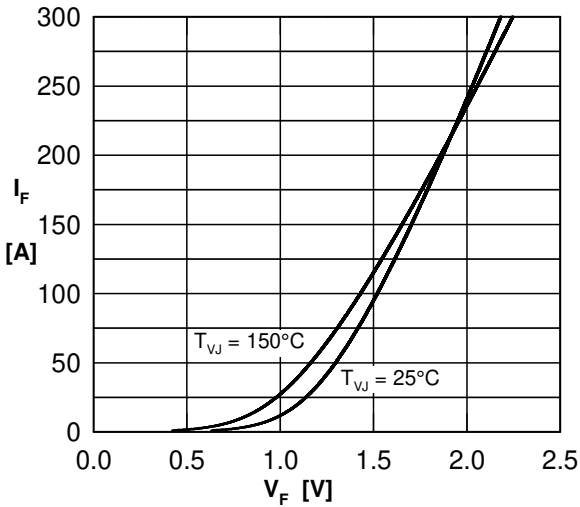


Fig. 12 Typ. forward characteristics FWD

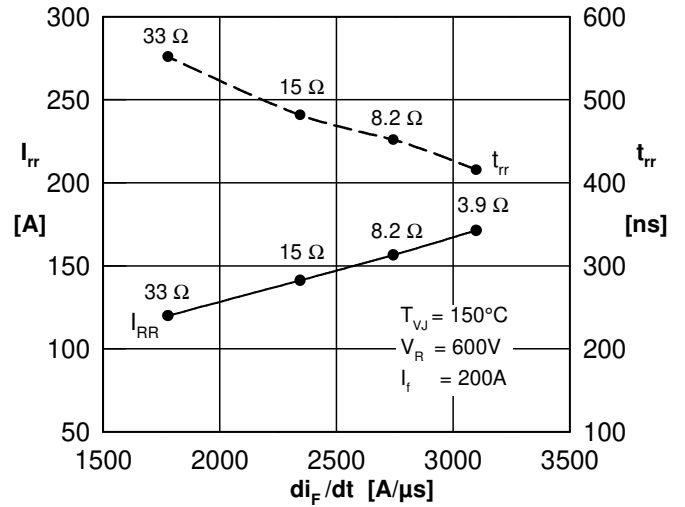


Fig. 13 Typ. recovery energy $E_{rec(off)}$ versus $-di/dt$

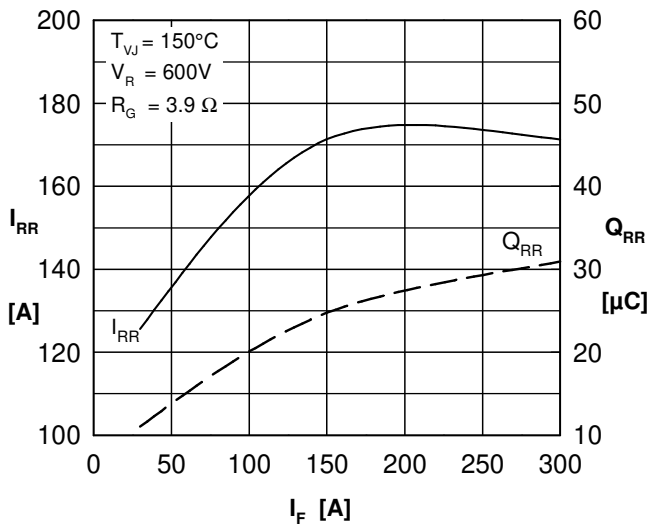


Fig. 14 typ. reverse recovery characteristics

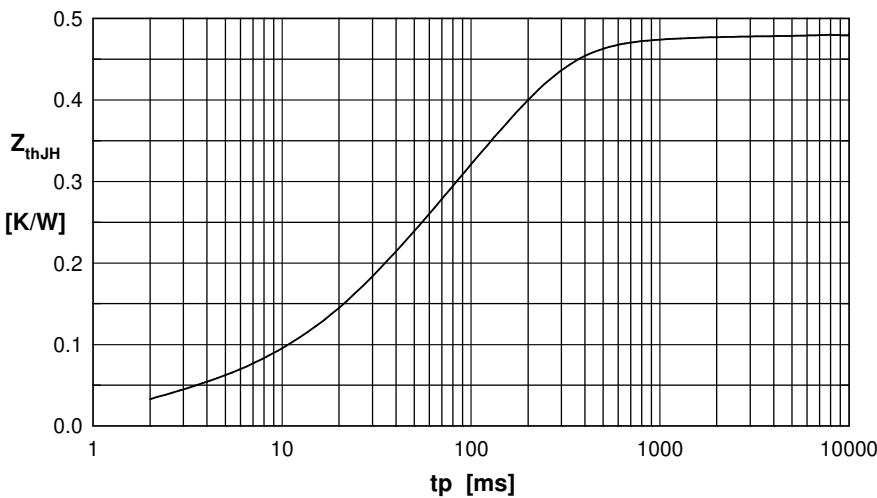


Fig. 15 Diode: typ. transient thermal impedance junction to heat sink