

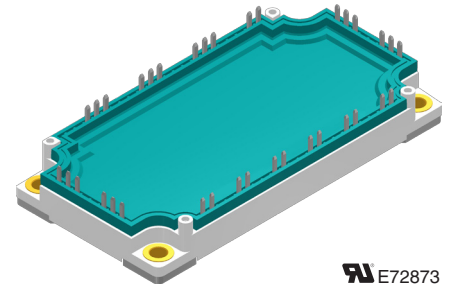
X2PT IGBT Module


$V_{CES} = 1200 \text{ V}$
 $I_{C25} = 325 \text{ A}$
 $V_{CE(sat)} = 1.7 \text{ V}$

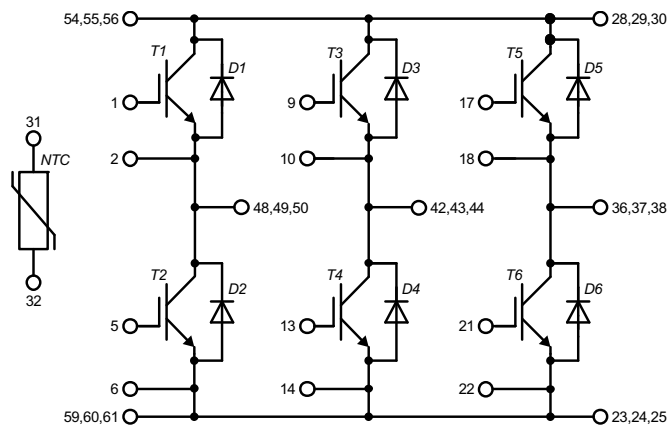
6-Pack + NTC

Part number

MIXG240W1200TEH



 E72873



Features / Advantages:

- X2PT - 2nd generation Xtreme light Punch Through
- $T_{vjm} = 175^{\circ}\text{C}$
- Easy paralleling due to the positive temperature coefficient of the on-state voltage
- Rugged X2PT design results in:
 - short circuit rated for 10 μsec .
 - very low gate charge
 - low EMI
 - square RBSOA @ 2x I_c
- Low $V_{CE(sat)}$ and low thermal resistance
- SONIC™ diode
 - fast and soft reverse recovery
 - low operating forward voltage

Applications:

- AC motor drives
- Solar inverter
- Medical equipment
- Uninterruptible power supply
- Air-conditioning systems
- Welding equipment
- Switched-mode and resonant-mode power supplies
- Inductive heating, cookers
- Pumps, Fans

Package: E3-Pack

- Isolation Voltage: 4300 V~
- Industry standard outline
- RoHS compliant
- Base plate: Copper internally DCB isolated
- Advanced power cycling
- Solder pins

Option:

- Phase Change Material printed on base plate

Disclaimer Notice

Information furnished is believed to be accurate and reliable. However, users should independently evaluate the suitability of and test each product selected for their own applications. Littelfuse products are not designed for, and may not be used in, all applications. Read complete Disclaimer Notice at www.littelfuse.com/disclaimer-electronics.

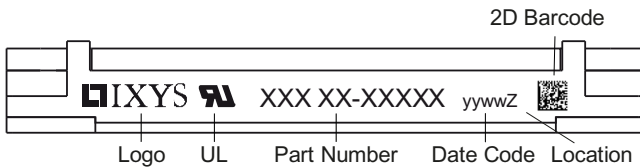


Inverter IGBT T1 - T6				Ratings		
Symbol	Definitions	Conditions	min.	typ.	max.	
V_{CES}	collector emitter voltage	$T_{VJ} = 25^{\circ}\text{C}$			1200	V
V_{GES}	max. DC gate voltage		-20		+20	V
V_{GEM}	max. transient gate emitter voltage		-30		+30	V
I_{C25}	collector current	$T_C = 25^{\circ}\text{C}$			325	A
I_{C80}	on die level	$T_C = 80^{\circ}\text{C}$			243	A
I_{C100}		$T_C = 100^{\circ}\text{C}$			208	A
P_{tot}	total power dissipation	$T_C = 25^{\circ}\text{C}$			1000	W
$V_{CE(sat)}$	collector emitter saturation voltage on die level	$I_C = 200\text{ A}; V_{GE} = 15\text{ V}$		1.7 2	2	V V
$V_{GE(th)}$	gate emitter threshold voltage	$I_C = 8\text{ mA}; V_{GE} = V_{GE}$	5.5		7.5	V
I_{CES}	collector emitter leakage current	$V_{CE} = V_{CES}; V_{GE} = 0\text{ V}$		5	0.6	mA mA
I_{GES}	gate emitter leakage current	$V_{GE} = \pm 20\text{ V}$			500	nA
R_G	internal gate resistance			5.6		Ω
C_{iss}	input capacitance	$V_{CE} = 100\text{ V}; V_{GS} = 0\text{ V}; f = 1\text{ MHz}$		10.6		nF
C_{oss}	output capacitance					pF
C_{rss}	reverse transfer (Miller) capacitance					pF
Q_g	total gate charge	$V_{CE} = 600\text{ V}; V_{GE} = 15\text{ V}; I_C = 200\text{ A}$		630		nC
Q_{gs}	gate source charge					nC
Q_{gd}	gate drain (Miller) charge					nC
$t_{d(on)}$	turn-on delay time	Inductive switching $V_{CE} = 600\text{ V}; I_C = 200\text{ A}$ $V_{GE} = \pm 15\text{ V}; R_G = 3.9\ \Omega$ (external)	$T_{VJ} = 25^{\circ}\text{C}$		170	ns
t_r	current rise time				54	ns
$t_{d(off)}$	turn-off delay time				298	ns
t_f	current fall time				138	ns
E_{on}	turn-on energy per pulse				15.5	mJ
E_{off}	turn-off energy per pulse				16.1	mJ
$E_{rec(off)}$	reverse recovery losses at turn-off				4.7	mJ
$t_{d(on)}$	turn-on delay time	Inductive switching $V_{CE} = 600\text{ V}; I_C = 200\text{ A}$ $V_{GE} = \pm 15\text{ V}; R_G = 3.9\ \Omega$ (external)	$T_{VJ} = 100^{\circ}\text{C}$		176	ns
t_r	current rise time				64	ns
$t_{d(off)}$	turn-off delay time				336	ns
t_f	current fall time				188	ns
E_{on}	turn-on energy per pulse				19.6	mJ
E_{off}	turn-off energy per pulse				19.7	mJ
$E_{rec(off)}$	reverse recovery losses at turn-off				7.7	mJ
$t_{d(on)}$	turn-on delay time	Inductive switching $V_{CE} = 600\text{ V}; I_C = 200\text{ A}$ $V_{GE} = \pm 15\text{ V}; R_G = 3.9\ \Omega$ (external)	$T_{VJ} = 150^{\circ}\text{C}$		182	ns
t_r	current rise time				66	ns
$t_{d(off)}$	turn-off delay time				366	ns
t_f	current fall time				232	ns
E_{on}	turn-on energy per pulse				21.4	mJ
E_{off}	turn-off energy per pulse				22.0	mJ
$E_{rec(off)}$	reverse recovery losses at turn-off				10.3	mJ
RBSOA	reverse bias safe operating area	$V_{GE} = \pm 15\text{ V}; R_G = 3.9\ \Omega$ $V_{CEmax} = 1200\text{ V}$	$T_{VJ} = 150^{\circ}\text{C}$		400	A
SCSOA	short circuit safe operating area	$V_{CEmax} = 1200\text{ V}$ $V_{CE} = 900\text{ V}; V_{GE} = \pm 15\text{ V}$ non-repetitive	$T_{VJ} = 150^{\circ}\text{C}$		10	μs
t_{SC}	short circuit duration				900	A
I_{SC}	short circuit current					
R_{thJC}	thermal resistance junction to case	with heatsink compound; IXYS test setup		0.195	0.15	K/W
R_{thJH}	thermal resistance junction to heatsink					K/W



Inverter Diode D1 - D6				Ratings		
Symbol	Definitions	Conditions	min.	typ.	max.	
V_{RRM}	max. repetitive reverse voltage				1200	V
I_{F25}	forward current				235	A
I_{F80}	on die level				170	A
I_{F100}					145	A
V_F	forward voltage on die level	$I_F = 200$ A		1.9	2.2	V
I_R	reverse current * not applicable, see Ices at IGBT	$V_R = V_{RRM}$		*	*	mA
di/dt	rate of change of current	$V_{CE} = 600$ V; $I_C = 200$ A $V_{GE} = \pm 15$ V; $R_G = 3.9$ Ω (external)		3300		A/ μ s
Q_{RM}	reverse recovery charge		$T_{VJ} = 25^\circ$ C	13		μ C
I_{RM}	max. reverse recovery current			129		A
t_{rr}	reverse recovery time			286		ns
E_{rec}	reverse recovery energy			4.7		mJ
di/dt	rate of change of current	$V_{CE} = 600$ V; $I_C = 200$ A $V_{GE} = \pm 15$ V; $R_G = 3.9$ Ω (external)		3080		A/ μ s
Q_{RM}	reverse recovery charge		$T_{VJ} = 100^\circ$ C	20.4		μ C
I_{RM}	max. reverse recovery current			145		A
t_{rr}	reverse recovery time			384		ns
E_{rec}	reverse recovery energy			7.7		mJ
di/dt	rate of change of current	$V_{CE} = 600$ V; $I_C = 200$ A $V_{GE} = \pm 15$ V; $R_G = 3.9$ Ω (external)		2715		A/ μ s
Q_{RM}	reverse recovery charge		$T_{VJ} = 150^\circ$ C	27		μ C
I_{RM}	max. reverse recovery current			158		A
t_{rr}	reverse recovery time			458		ns
E_{rec}	reverse recovery energy			10.3		mJ
R_{thJC}	thermal resistance junction to case	with heatsink compound; IXYS test setup			0.28	K/W
R_{thJH}	thermal resistance junction to heatsink				0.37	K/W

Package E3-Pack				Ratings		
Symbol	Definitions	Conditions	min.	typ.	max.	Unit
I_{RMS}	RMS current	per terminal			30	A
T_{stg}	storage temperature		-40		125	°C
T_{op}	operation temperature		-40		150	°C
T_{VJ}	virtual junction temperature		-40		175	°C
Weight				295		g
M_D	mounting torque		3		6	Nm
d_{Spp}	creepage distance on surface	terminal to terminal	6			mm
d_{Spb}		terminal to backside	12			mm
d_{App}	striking distance through air	terminal to terminal	6			mm
d_{Apb}		terminal to backside	12			mm
V_{ISOL}	isolation voltage	t = 1 second t = 1 minute	4300 3600	50 / 60 Hz, RMS; $I_{ISOL} \leq 1$ mA		V V
$R_{pin-chip}$	resistance pin to chip	$V = V_{CEsat} + 2 \cdot R \cdot I_C$ resp. $V = V_F + 2 \cdot R \cdot I_F$			1.5	mΩ
C_P	coupling capacity per switch	between shorted pins of switch and back side metallization				pF

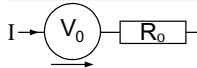

Part number

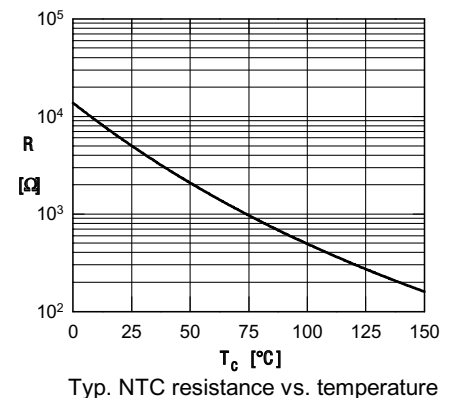
M = Module
 I = IGBT
 X = XPT IGBT
 G = Gen 2 / std
 240 = Current Rating [A]
 W = 6-pack
 1200 = Reverse Voltage [V]
 T = Thermistor
 EH = E3-Pack

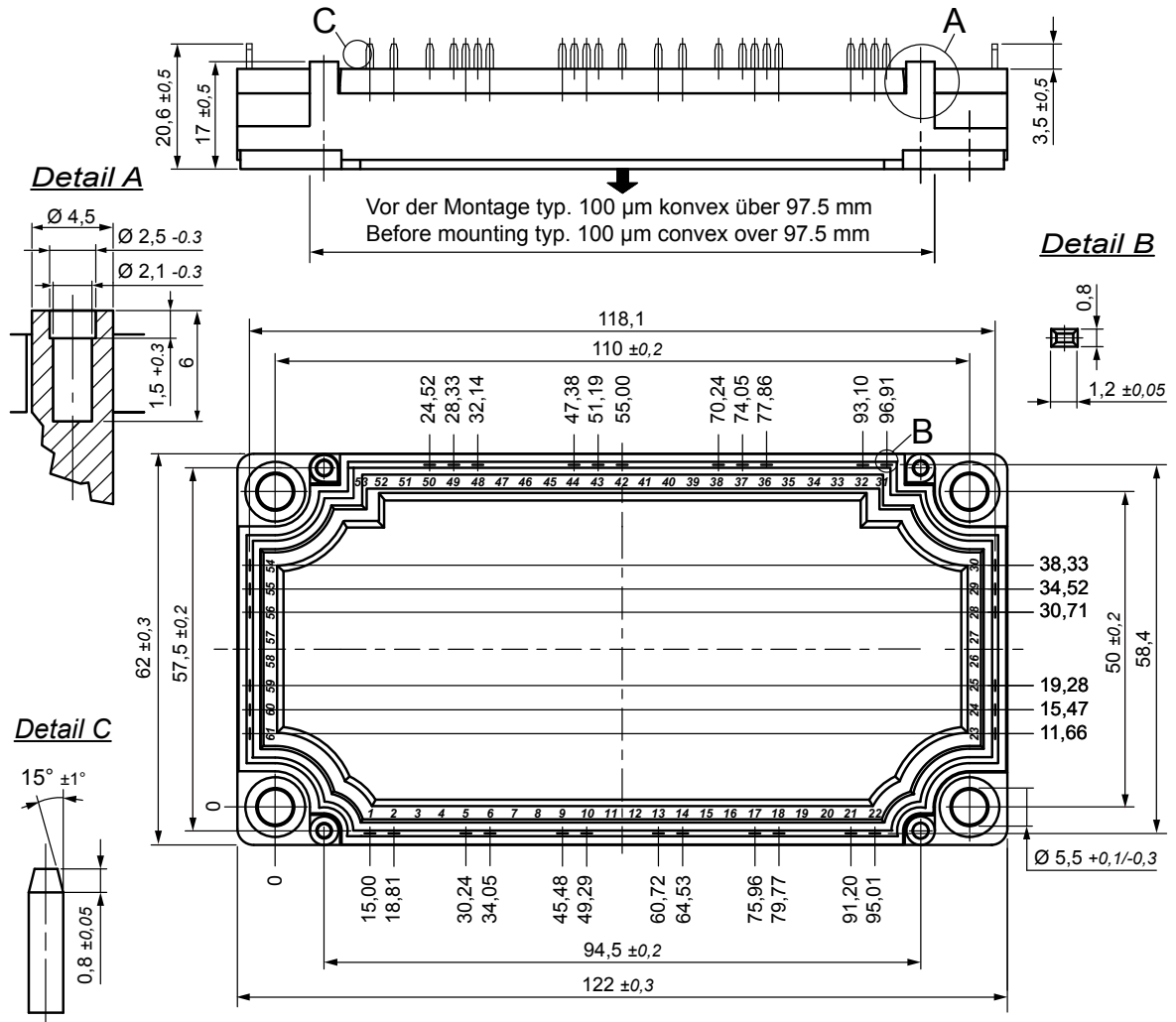
Ordering	Part Name	Marking on Product	Delivering Mode	Base Qty	Ordering Code
Standard	MIXG240W1200TEH	MIXG240W1200TEH	Box	5	517094
with Phase Change Material	MIXG240W1200TEH -PC	MIXG240W1200TEH	Blister	24	

Similar Part	Package	Voltage class
MIXG240W1200PTEH	E3- Pack, press fit pin	1200
MIXG240W1200PSTEH	E3- Pack, press fit pin + shunt	1200
MIXG240W1200STEH	E3- Pack, shunt	1200

Option: phase change material; please contact IXYS sales office for availability

Temperature Sensor NTC						
Symbol	Definitions	Conditions	min.	typ.	max.	Unit
R_{25}	resistance	$T_{VJ} = 25^\circ\text{C}$	4.75	5.0	5.25	kΩ
$B_{25/50}$	temperature coefficient			3375		K
Equivalent Circuits for Simulation <small>*on die level</small>						
			IGBT	Inverter Diode		
$V_{0\max}$	threshold voltage	$T_{VJ} = 175^\circ\text{C}$	1.2	1.2		V
$R_{0\max}$	slope resistance *		5.8	4.7		mΩ

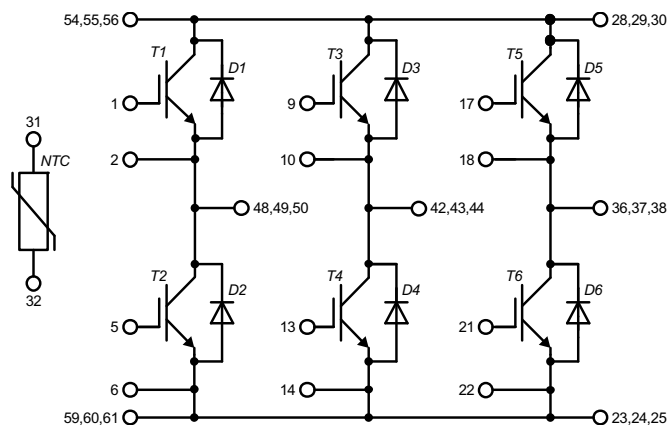


Outlines E3-Pack

Bemerkung / Note:

- Nichttolerierete Maße nach / Measure without tolerances according DIN ISO 2768-T1-m
- PCB-Lochmuster / PCB hole pattern: **see pin position**
- Toleranz Pin-Position und PCB-Lochmuster / Tolerance of pin position and PCB hole pattern: $\oplus 0.1$
- Montageanleitung / Mounting instruction: www.ixys.com **Application note IXAN0024**

Detail A: PCB-Montage / Mounting on PCB

- Empfohlene, selbstschneidende Schraube / Recommended, self-tapping screw: **EJOT PT®** (Größe / size: **K25**)
- Max. Schraubenlänge / Max. screw length: **PCB-Dicke / thickness + 6 mm** (max. Lochtiefe / hole depth)
- Empfohlenes Drehmoment / Recommended mounting torque: **1.5 Nm**



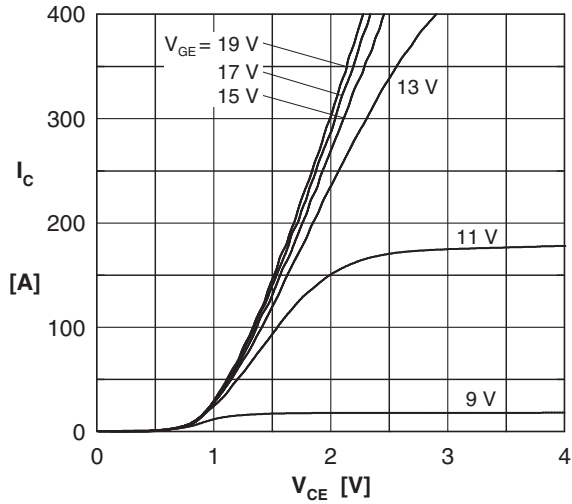
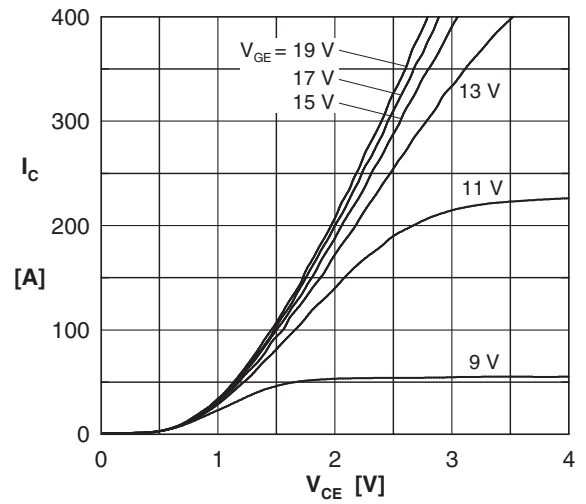
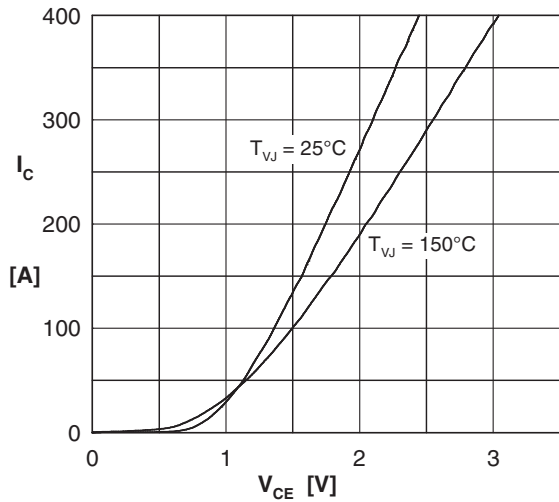
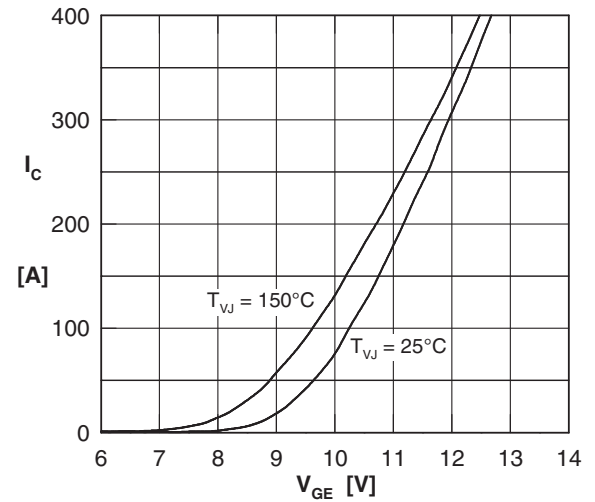
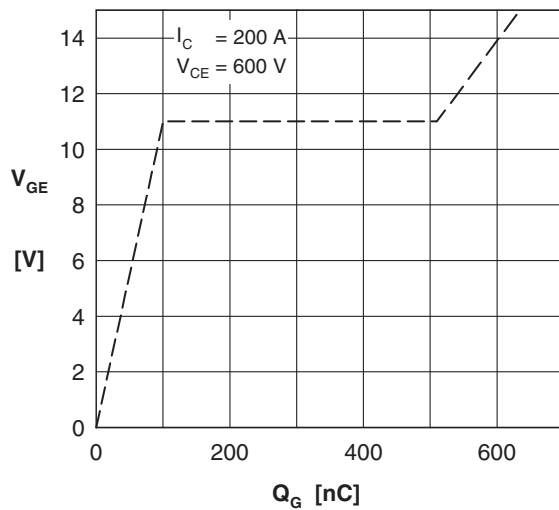
IGBT T1 - T6

 Fig. 1 Typ. output characteristics ($T_{VJ} = 25^{\circ}\text{C}$)

 Fig. 2 Typ. output characteristics ($T_{VJ} = 150^{\circ}\text{C}$)

 Fig. 3 Typ. output characteristics ($V_{GE} = 15\text{V}$)

 Fig. 4 Typ. transfer characteristics ($V_{CE} = 20\text{V}$)


Fig. 5 Typ. turn-on gate charge 0/15V

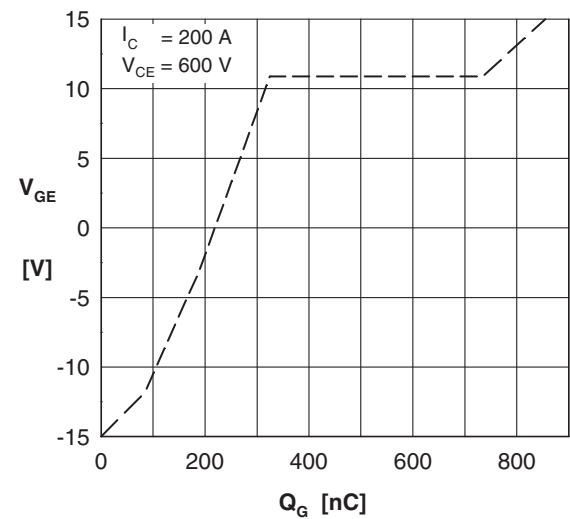


Fig. 6 Typ. turn-on gate charge -15/+15V

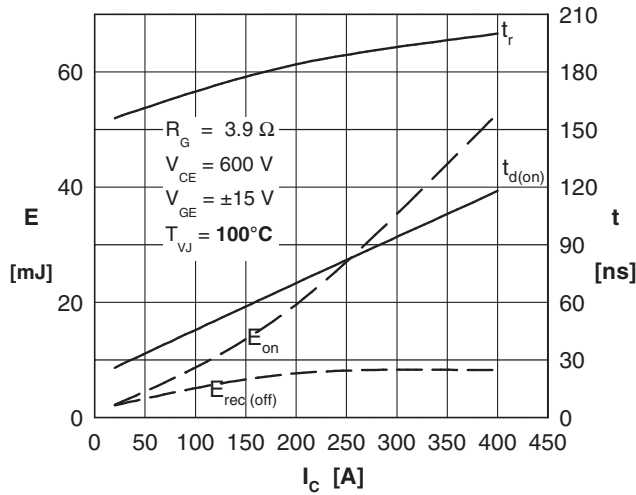
IGBT T1 - T6


Fig. 7 Typ. switching energy versus collector current (turn on)

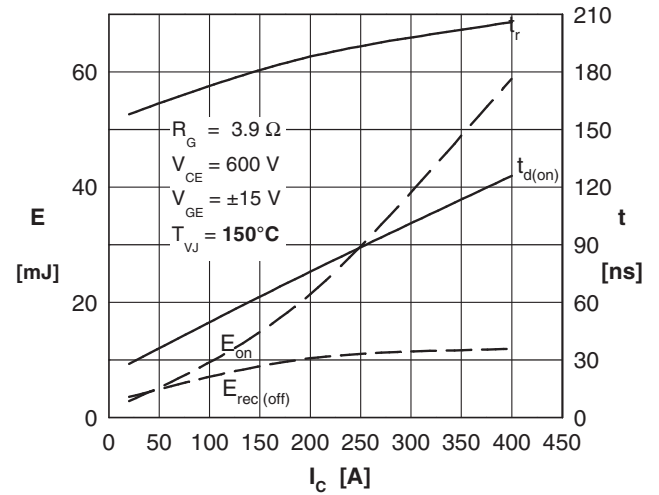


Fig. 8 Typ. switching energy versus collector current (turn on)

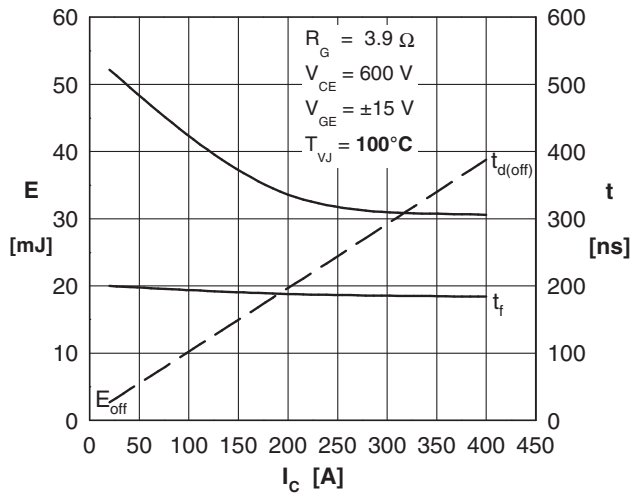


Fig. 9 Typ. switching energy versus collector current (turn off)

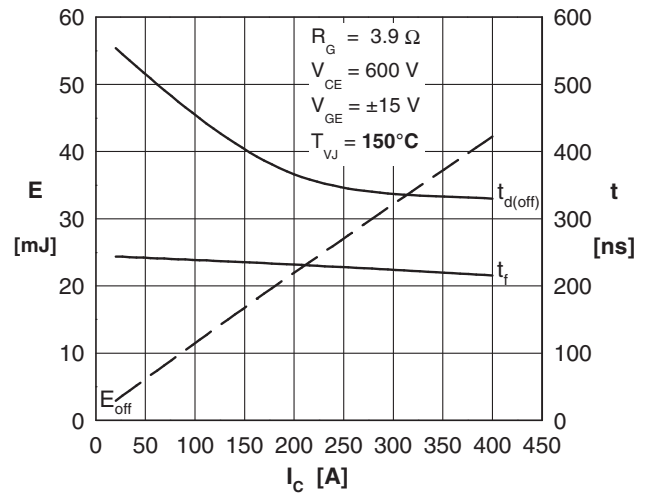


Fig. 10 Typ. switching energy versus collector current (turn off)

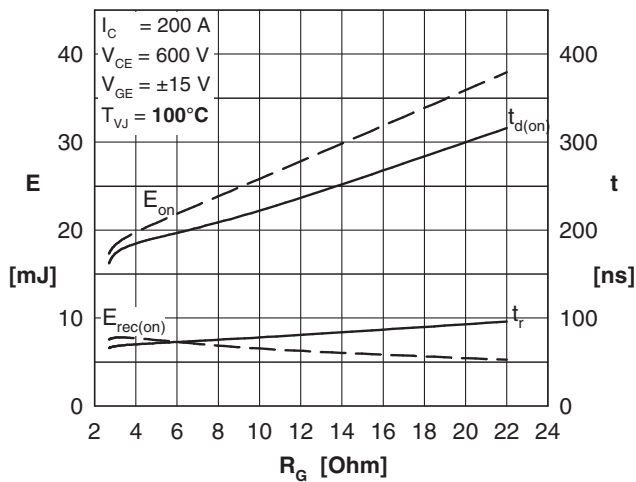


Fig. 11 Typ. switching energy versus gate resistor (turn on)

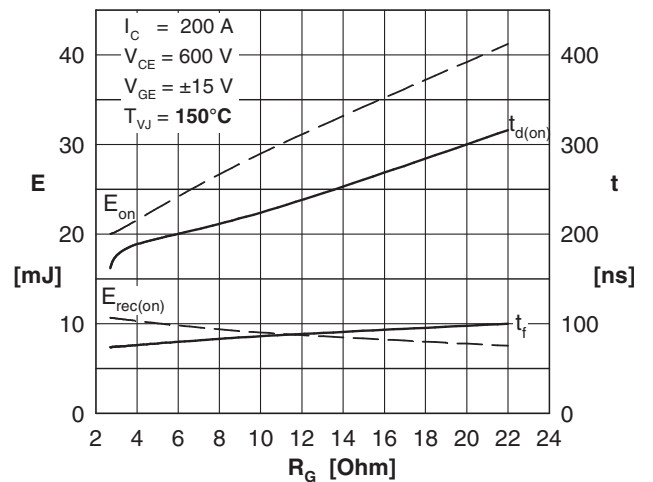


Fig. 12 Typ. switching energy versus gate resistor (turn on)

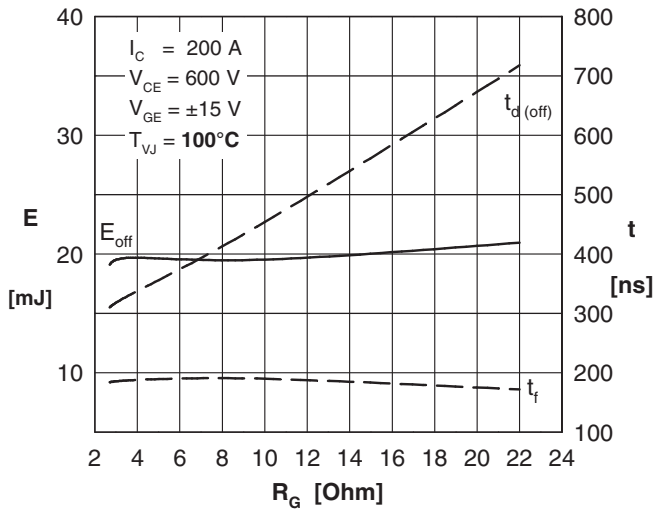
IGBT T1 - T6


Fig. 13 Typ. switching energy versus gate resistor (turn off)

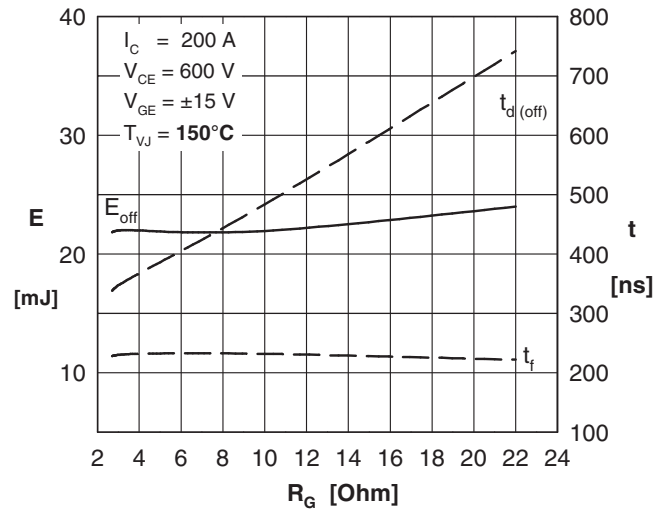


Fig. 14 Typ. switching energy versus gate resistor (turn off)

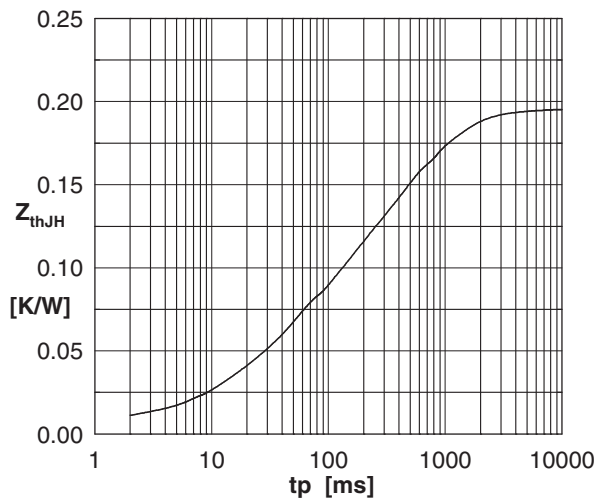


Fig. 15 IGBT: Typ. transient thermal impedance junction to heat sink

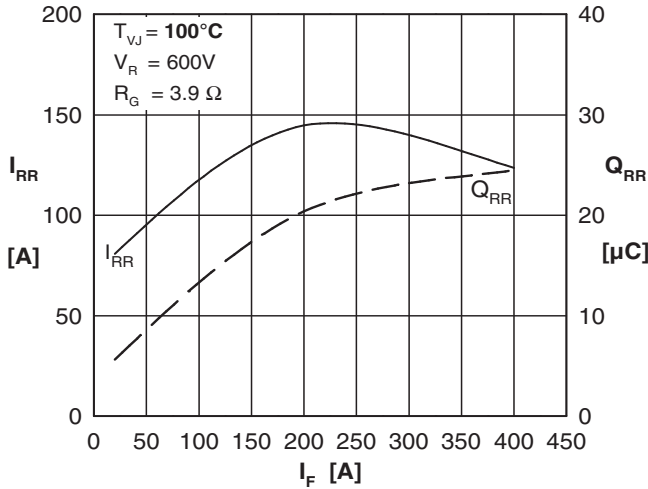
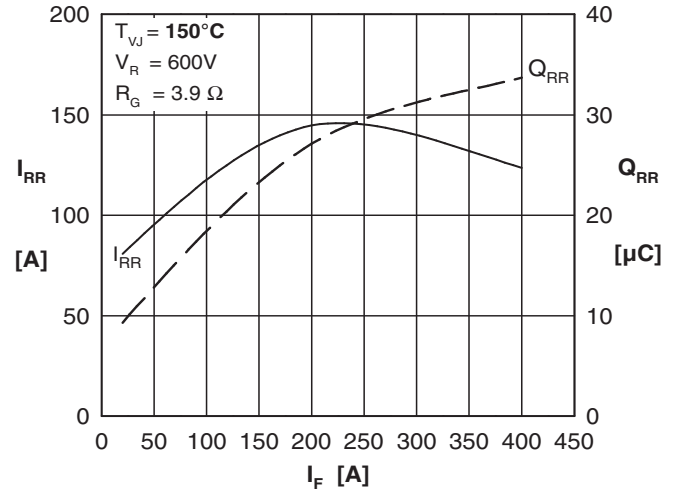
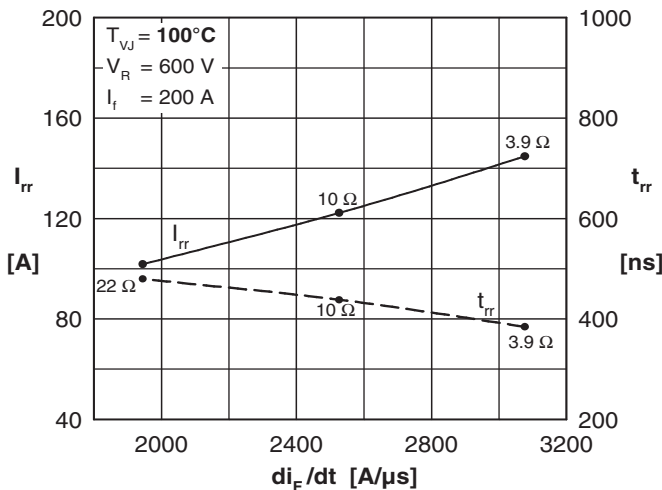
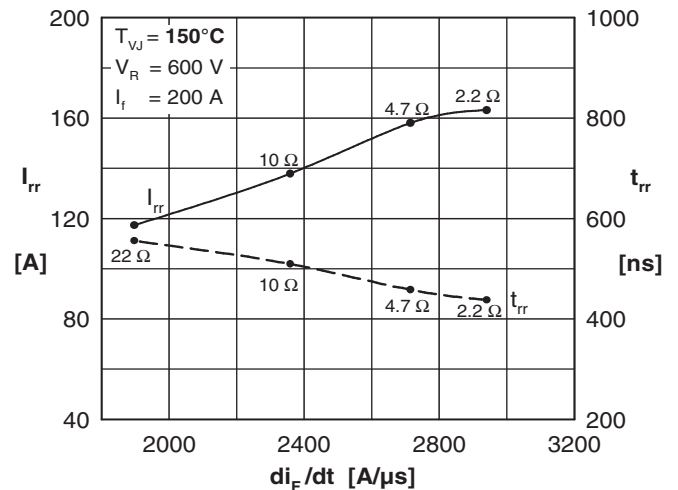
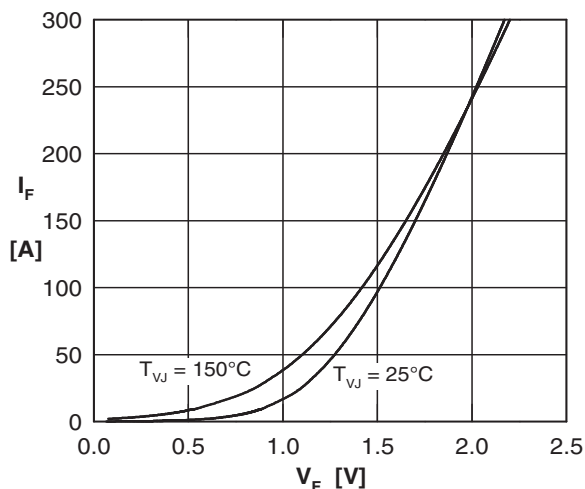
DIODE D1 - D6

 Fig. 16 Typ. reverse recovery characteristics versus diode current I_F

 Fig. 17 Typ. reverse recovery characteristics versus diode current I_F

 Fig. 18 Typ. reverse recovery characteristics versus $-di/dt$

 Fig. 19 Typ. reverse recovery characteristics versus $-di/dt$


Fig. 20 Typ. forward characteristics of free wheeling diode

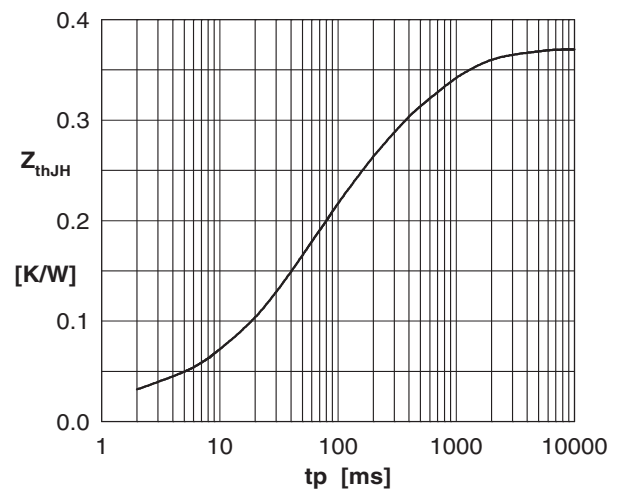


Fig. 21 Diode: Typ. transient thermal impedance junction to heat sink