

# HiPerFRED Module

$V_{RRM} = 1200\text{ V}$   
 $I_{DAV} = 32\text{ A}$   
 $t_{rr} = 40\text{ ns}$

High Performance Fast Recovery Diode  
 Low Loss and Soft Recovery  
 1~ Rectifier Bridge

Part number

**VBE26-12NO7**

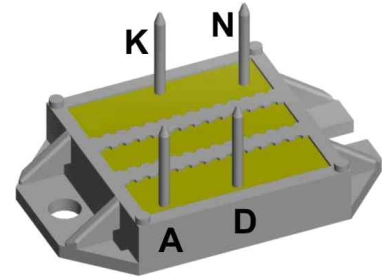

Backside: isolated

 E72873

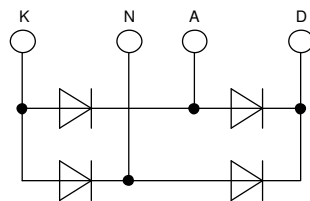

## Features / Advantages:

- Planar passivated chips
- Very low leakage current
- Very short recovery time
- Improved thermal behaviour
- Very low  $I_{rm}$ -values
- Very soft recovery behaviour
- Avalanche voltage rated for reliable operation
- Soft reverse recovery for low EMI/RFI
- Low  $I_{rm}$  reduces:
  - Power dissipation within the diode
  - Turn-on loss in the commutating switch

## Applications:

- Antiparallel diode for high frequency switching devices
- Antisaturation diode
- Snubber diode
- Free wheeling diode
- Rectifiers in switch mode power supplies (SMPS)
- Uninterruptible power supplies (UPS)

## Package: ECO-PAC1

- Isolation Voltage: 3600 V~
- Industry standard outline
- RoHS compliant
- Epoxy meets UL 94V-0
- Base plate: Copper internally DCB isolated
- Advanced power cycling

## Disclaimer Notice

Information furnished is believed to be accurate and reliable. However, users should independently evaluate the suitability of and test each product selected for their own applications. Littelfuse products are not designed for, and may not be used in, all applications. Read complete Disclaimer Notice at [www.littelfuse.com/disclaimer-electronics](http://www.littelfuse.com/disclaimer-electronics).



Fast Diode				Ratings			
Symbol	Definition	Conditions		min.	typ.	max.	Unit
$V_{RSM}$	max. non-repetitive reverse blocking voltage					1200	V
$V_{RRM}$	max. repetitive reverse blocking voltage					1200	V
$I_R$	reverse current, drain current	$V_R = 1200\text{ V}$	$T_{VJ} = 25^\circ\text{C}$			100	$\mu\text{A}$
		$V_R = 1200\text{ V}$	$T_{VJ} = 150^\circ\text{C}$			0.5	mA
$V_F$	forward voltage drop	$I_F = 15\text{ A}$	$T_{VJ} = 25^\circ\text{C}$			2.73	V
		$I_F = 30\text{ A}$				3.20	V
		$I_F = 15\text{ A}$	$T_{VJ} = 150^\circ\text{C}$			1.75	V
		$I_F = 30\text{ A}$				2.20	V
$I_{DAV}$	bridge output current	$T_C = 85^\circ\text{C}$ rectangular $d = 0.5$	$T_{VJ} = 150^\circ\text{C}$			32	A
$V_{FO}$	threshold voltage	} for power loss calculation only				1.32	V
$r_F$	slope resistance					30	m $\Omega$
$R_{thJC}$	thermal resistance junction to case					1.6	K/W
$R_{thCH}$	thermal resistance case to heatsink				0.30		K/W
$P_{tot}$	total power dissipation			$T_C = 25^\circ\text{C}$		80	W
$I_{FSM}$	max. forward surge current	$t = 10\text{ ms}; (50\text{ Hz}), \text{ sine}; V_R = 0\text{ V}$	$T_{VJ} = 45^\circ\text{C}$			90	A
$C_J$	junction capacitance	$V_R = 400\text{ V}$ $f = 1\text{ MHz}$	$T_{VJ} = 25^\circ\text{C}$		7		pF
$I_{RM}$	max. reverse recovery current	} $I_F = 15\text{ A}; V_R = 600\text{ V}$ $-di_F/dt = 200\text{ A}/\mu\text{s}$		$T_{VJ} = 25^\circ\text{C}$		6	A
				$T_{VJ} = 100^\circ\text{C}$		9	A
$t_{rr}$	reverse recovery time			$T_{VJ} = 25^\circ\text{C}$		40	ns
				$T_{VJ} = 100^\circ\text{C}$		135	ns



Package ECO-PAC1		Ratings				
Symbol	Definition	Conditions	min.	typ.	max.	Unit
$I_{RMS}$	RMS current	per terminal			100	A
$T_{VJ}$	virtual junction temperature		-40		150	°C
$T_{op}$	operation temperature		-40		125	°C
$T_{stg}$	storage temperature		-40		125	°C
<b>Weight</b>				19		g
$M_D$	mounting torque		1.4		2	Nm
$d_{Spp/App}$	creepage distance on surface / striking distance through air	terminal to terminal	6.0			mm
$d_{Spb/Apb}$		terminal to backside	10.0			mm
$V_{ISOL}$	isolation voltage	t = 1 second	3600			V
		t = 1 minute	3000			V



Ordering	Ordering Number	Marking on Product	Delivery Mode	Quantity	Code No.
Standard	VBE26-12NO7	VBE26-12NO7	Box	25	482366

**Equivalent Circuits for Simulation**

\* on die level

$T_{VJ} = 150^{\circ}C$



**Fast Diode**

$V_{0\ max}$	threshold voltage	1.32	V
$R_{0\ max}$	slope resistance *	28	mΩ



**Outlines ECO-PAC1**

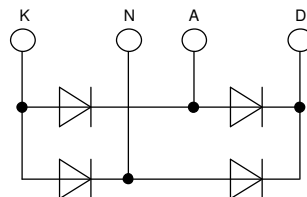
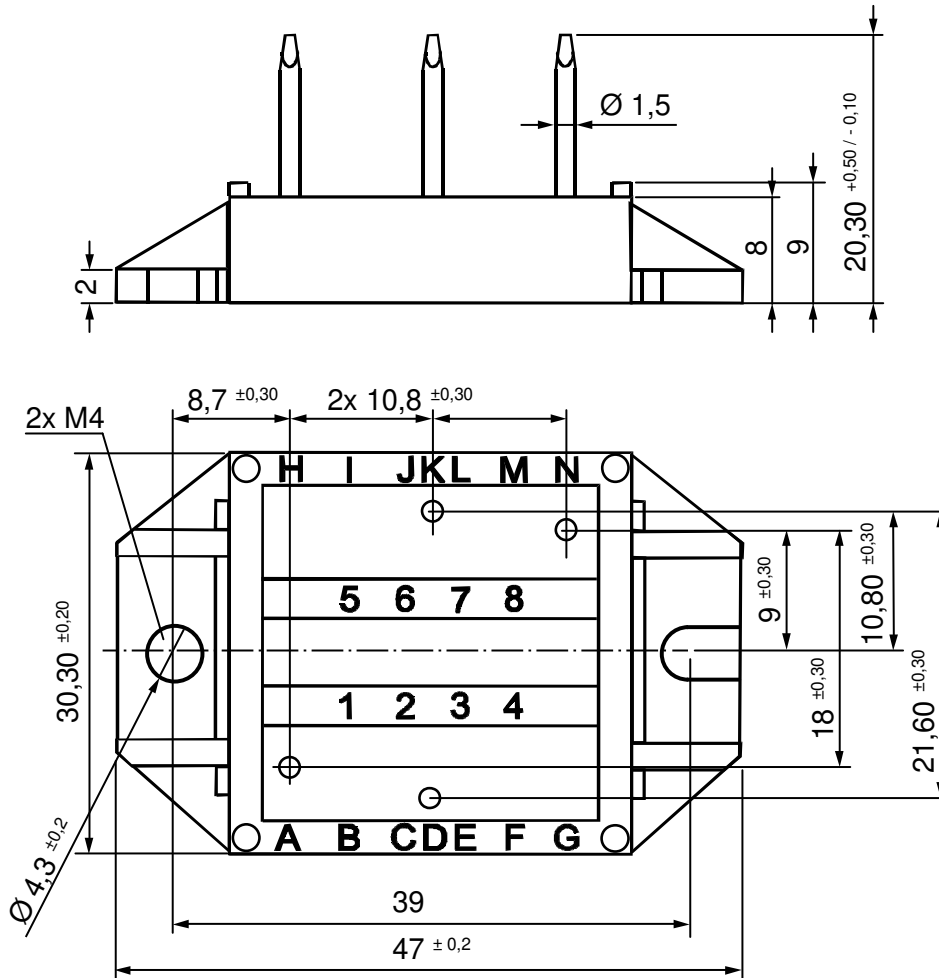



**Fast Diode**

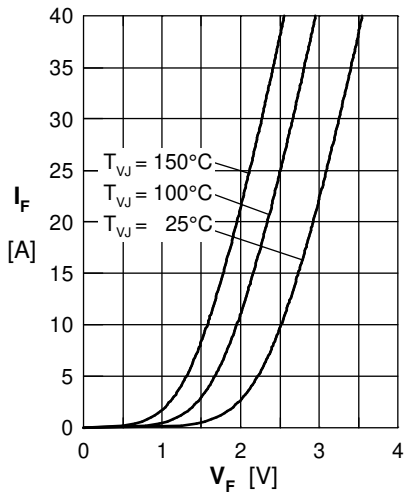

Fig. 1 Forward current  $I_F$  vs.  $V_F$

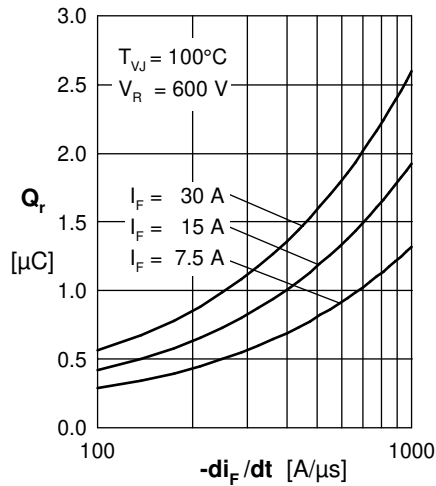

Fig. 2 Reverse recovery charge  $Q_r$  versus  $-di_F/dt$

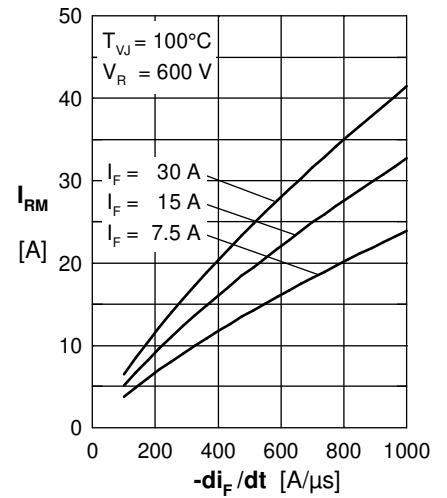

Fig. 3 Peak reverse current  $I_{RM}$  versus  $-di_F/dt$

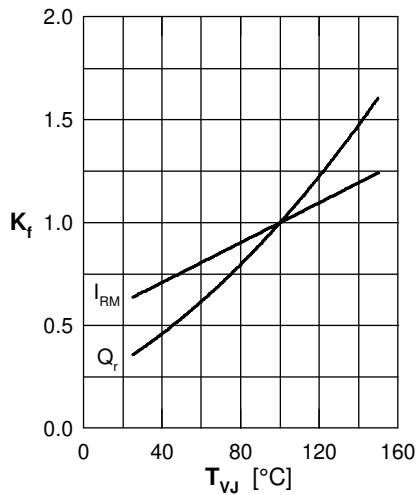

Fig. 4 Dynamic parameters  $Q_r$ ,  $I_{RM}$  versus  $T_{VJ}$

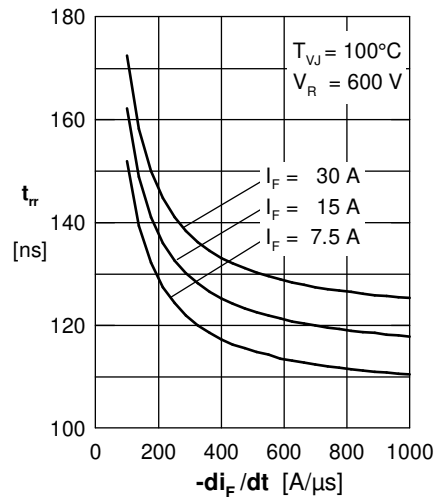

Fig. 5 Recovery time  $t_{tr}$  vs.  $-di_F/dt$

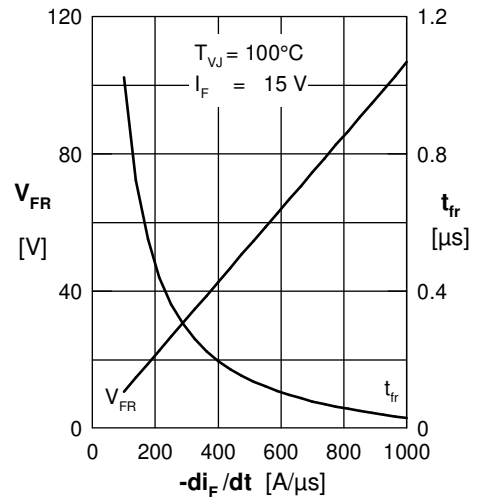

Fig. 6 Peak forward voltage  $V_{FR}$  and  $t_{tr}$  vs.  $-di_F/dt$

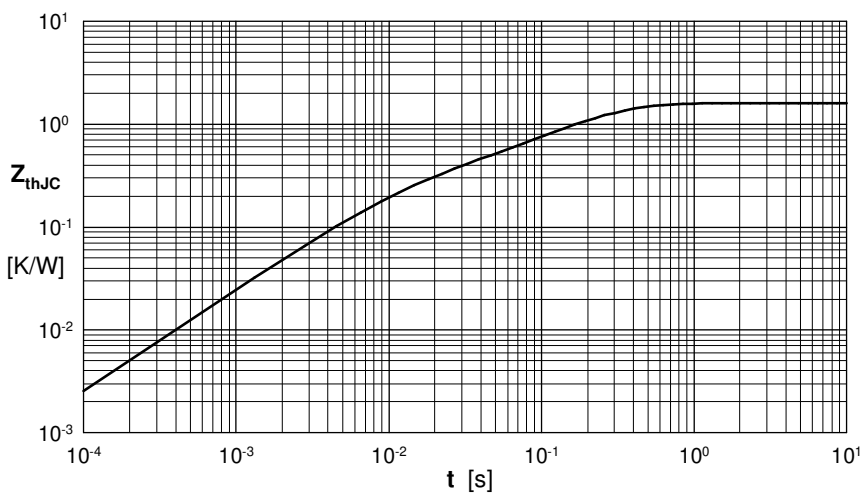

Fig. 7 Transient thermal resistance junction to case

Constants for  $Z_{thJC}$  calculation:

i	$R_{thi}$ (K/W)	$t_i$ (s)
1	0.5464	0.0052
2	0.2104	0.0003
3	0.0432	0.0004
4	0.8000	0.0092