

HiPerFRED Module

V_{RRM}	=	600 V
I_{DAV}	=	68 A
t_{rr}	=	35 ns

High Performance Fast Recovery Diode
 Low Loss and Soft Recovery
 1~ Rectifier Bridge

Part number

VBE55-06NO7

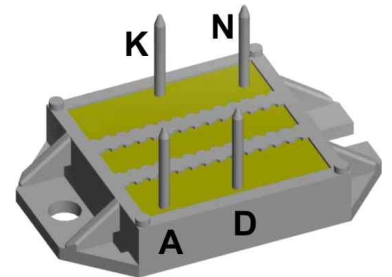

Backside: isolated

 E72873

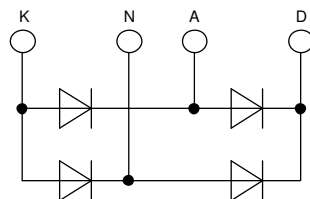

Features / Advantages:

- Planar passivated chips
- Very low leakage current
- Very short recovery time
- Improved thermal behaviour
- Very low I_{rm} -values
- Very soft recovery behaviour
- Avalanche voltage rated for reliable operation
- Soft reverse recovery for low EMI/RFI
- Low I_{rm} reduces:
 - Power dissipation within the diode
 - Turn-on loss in the commutating switch

Applications:

- Antiparallel diode for high frequency switching devices
- Antisaturation diode
- Snubber diode
- Free wheeling diode
- Rectifiers in switch mode power supplies (SMPS)
- Uninterruptible power supplies (UPS)

Package: ECO-PAC1

- Isolation Voltage: 3600 V~
- Industry standard outline
- RoHS compliant
- Epoxy meets UL 94V-0
- Base plate: Copper internally DCB isolated
- Advanced power cycling

Disclaimer Notice

Information furnished is believed to be accurate and reliable. However, users should independently evaluate the suitability of and test each product selected for their own applications. Littelfuse products are not designed for, and may not be used in, all applications. Read complete Disclaimer Notice at www.littelfuse.com/disclaimer-electronics.



Fast Diode				Ratings			
Symbol	Definition	Conditions	min.	typ.	max.	Unit	
V_{RSM}	max. non-repetitive reverse blocking voltage	$T_{VJ} = 25^{\circ}C$			600	V	
V_{RRM}	max. repetitive reverse blocking voltage	$T_{VJ} = 25^{\circ}C$			600	V	
I_R	reverse current, drain current	$V_R = 600 V$	$T_{VJ} = 25^{\circ}C$		250	μA	
		$V_R = 600 V$	$T_{VJ} = 150^{\circ}C$		1	mA	
V_F	forward voltage drop	$I_F = 30 A$	$T_{VJ} = 25^{\circ}C$		1.57	V	
		$I_F = 60 A$			1.87	V	
		$I_F = 30 A$	$T_{VJ} = 150^{\circ}C$		1.22	V	
		$I_F = 60 A$			1.49	V	
I_{DAV}	bridge output current	$T_C = 100^{\circ}C$ rectangular $d = 0.5$	$T_{VJ} = 150^{\circ}C$		68	A	
V_{FO}	threshold voltage	} for power loss calculation only	$T_{VJ} = 150^{\circ}C$		0.98	V	
r_F	slope resistance				8	m Ω	
R_{thJC}	thermal resistance junction to case				0.9	K/W	
R_{thCH}	thermal resistance case to heatsink			0.30		K/W	
P_{tot}	total power dissipation		$T_C = 25^{\circ}C$		140	W	
I_{FSM}	max. forward surge current	$t = 10 ms; (50 Hz), sine; V_R = 0 V$	$T_{VJ} = 45^{\circ}C$		250	A	
C_J	junction capacitance	$V_R = 400 V$ $f = 1 MHz$	$T_{VJ} = 25^{\circ}C$		26	pF	
I_{RM}	max. reverse recovery current	} $I_F = 30 A; V_R = 300 V$ $-di_F/dt = 200 A/\mu s$	$T_{VJ} = 25^{\circ}C$		6	A	
			$T_{VJ} = 100^{\circ}C$		10	A	
t_{rr}	reverse recovery time		$T_{VJ} = 25^{\circ}C$		35	ns	
			$T_{VJ} = 100^{\circ}C$		100	ns	



Package ECO-PAC1		Ratings				
Symbol	Definition	Conditions	min.	typ.	max.	Unit
I_{RMS}	RMS current	per terminal			100	A
T_{VJ}	virtual junction temperature		-40		150	°C
T_{op}	operation temperature		-40		125	°C
T_{stg}	storage temperature		-40		125	°C
Weight				19		g
M_D	mounting torque		1.4		2	Nm
$d_{Spp/App}$	creepage distance on surface / striking distance through air	terminal to terminal	6.0			mm
$d_{Spb/Apb}$		terminal to backside	10.0			mm
V_{ISOL}	isolation voltage	t = 1 second	3600			V
		t = 1 minute	3000			V



Ordering	Ordering Number	Marking on Product	Delivery Mode	Quantity	Code No.
Standard	VBE55-06NO7	VBE55-06NO7	Box	25	482781

Equivalent Circuits for Simulation

* on die level

$T_{VJ} = 150^{\circ}C$



Fast Diode

$V_{0\ max}$	threshold voltage	0.98	V
$R_{0\ max}$	slope resistance *	6	mΩ



Outlines ECO-PAC1

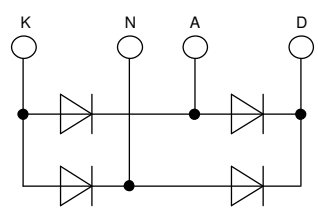
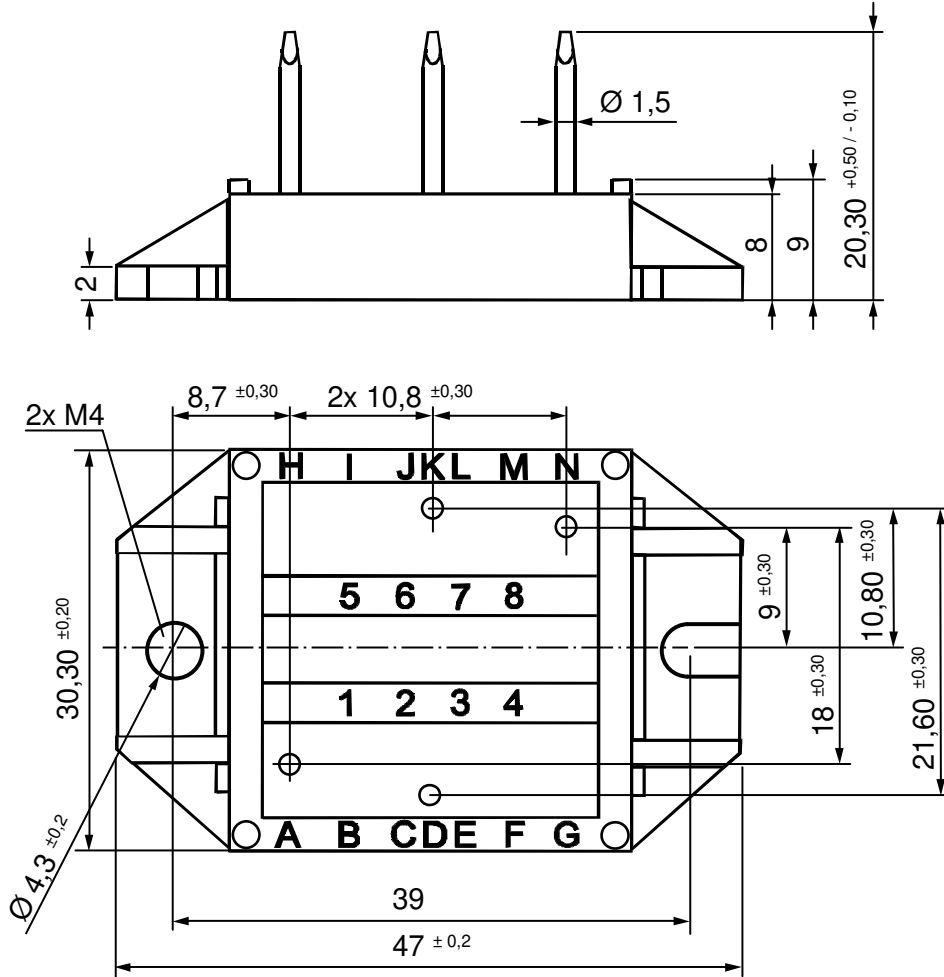

Fast Diode

 Fig. 1 Forward current I_F vs. V_F

 Fig. 2 Reverse recovery charge Q_r versus $-di_F/dt$

 Fig. 3 Peak reverse current I_{RM} versus $-di_F/dt$

 Fig. 4 Dynamic parameters Q_r , I_{RM} versus T_{VJ}

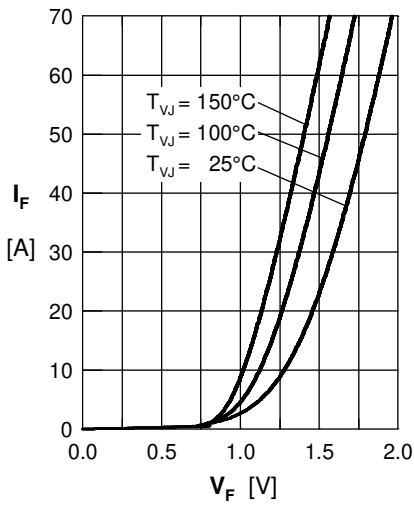
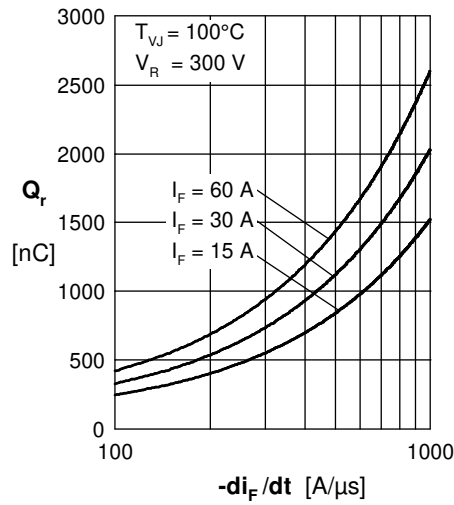
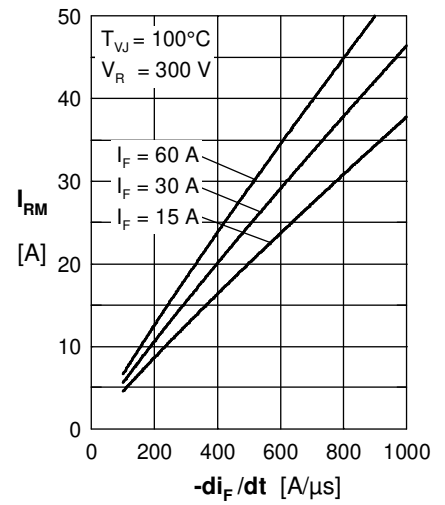
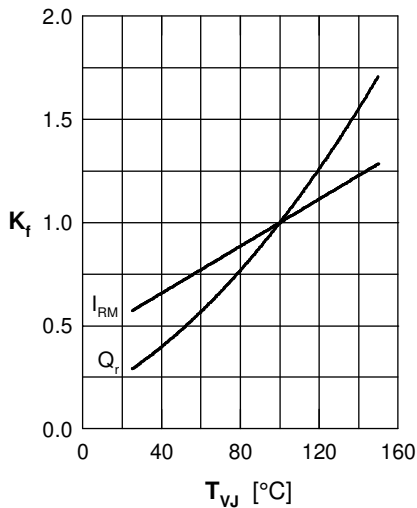
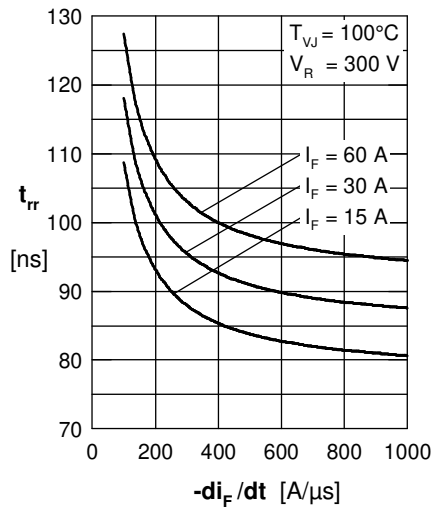
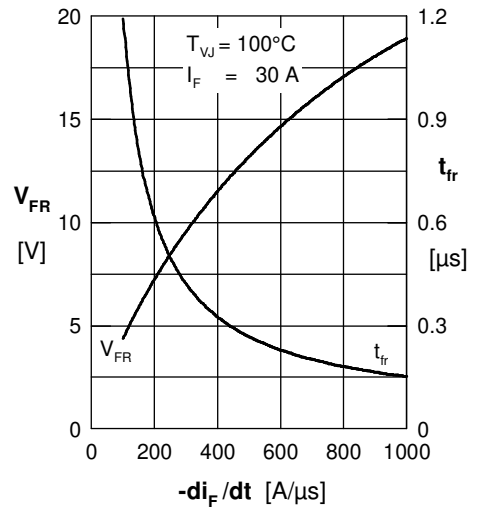
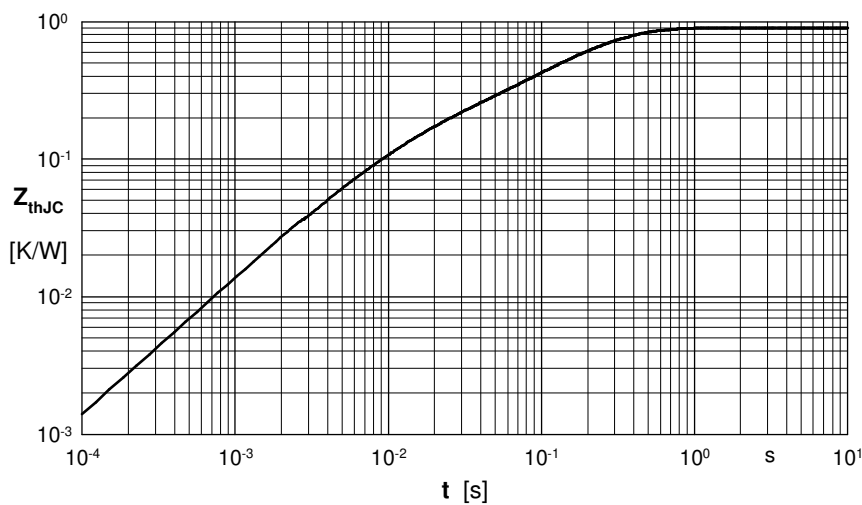
 Fig. 5 Recovery time t_{rr} versus $-di_F/dt$

 Fig. 6 Peak forward voltage V_{FR} and t_{fr} vs. $-di_F/dt$

Fig. 7 Transient thermal resistance junction to case

 Constants for Z_{thJC} calculation:

i	R_{thi} (K/W)	t_i (s)
1	0.3012	0.0052
2	0.1160	0.0003
3	0.0241	0.0004
4	0.4586	0.0092