

Standard Rectifier Module

3~ Rectifier	Brake Chopper
$V_{RRM} = 1600 \text{ V}$	$V_{CES} = 1200 \text{ V}$
$I_{DAV} = 120 \text{ A}$	$I_{C25} = 120 \text{ A}$
$I_{FSM} = 700 \text{ A}$	$V_{CE(sat)} = 1.8 \text{ V}$

3~ Rectifier Bridge + Brake Unit + NTC

Part number

VUB116-16NOXT

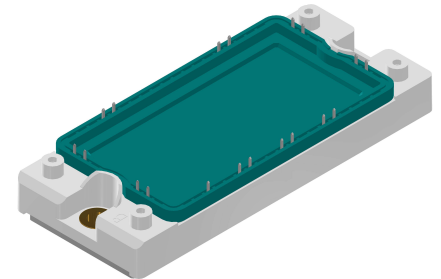

Backside: isolated

 E72873

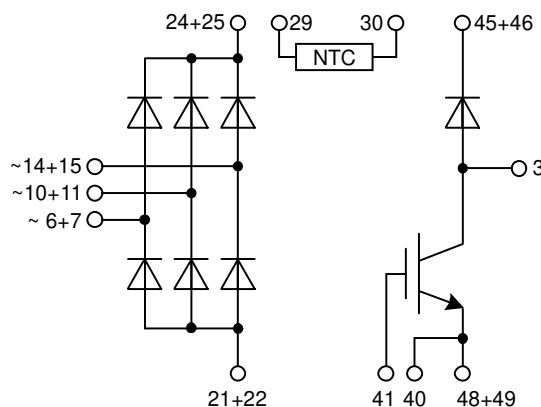

Features / Advantages:

- Package with DCB ceramic
- Improved temperature and power cycling
- Planar passivated chips
- Very low forward voltage drop
- Very low leakage current
- NTC

Applications:

- 3~ Rectifier with brake unit for drive inverters

Package: E2-Pack

- Isolation Voltage: 3600 V~
- Industry standard outline
- RoHS compliant
- Soldering pins for PCB mounting
- Height: 17 mm
- Base plate: Copper internally DCB isolated
- Advanced power cycling
- Phase Change Material available

Disclaimer Notice

Information furnished is believed to be accurate and reliable. However, users should independently evaluate the suitability of and test each product selected for their own applications. Littelfuse products are not designed for, and may not be used in, all applications. Read complete Disclaimer Notice at www.littelfuse.com/disclaimer-electronics.

Rectifier				Ratings			
Symbol	Definition	Conditions		min.	typ.	max.	Unit
V_{RSM}	max. non-repetitive reverse blocking voltage					1700	V
V_{RRM}	max. repetitive reverse blocking voltage					1600	V
I_R	reverse current	$V_R = 1600$ V		$T_{VJ} = 25^\circ\text{C}$		100	μA
		$V_R = 1600$ V		$T_{VJ} = 150^\circ\text{C}$		1.5	mA
V_F	forward voltage drop	$I_F = 40$ A		$T_{VJ} = 25^\circ\text{C}$		1.19	V
		$I_F = 120$ A				1.64	V
		$I_F = 40$ A		$T_{VJ} = 125^\circ\text{C}$		1.12	V
		$I_F = 120$ A				1.70	V
I_{DAV}	bridge output current	$T_C = 105^\circ\text{C}$	rectangular	$T_{VJ} = 150^\circ\text{C}$		120	A
V_{FO}	threshold voltage	} for power loss calculation only				0.80	V
r_F	slope resistance					7.6	m Ω
R_{thJC}	thermal resistance junction to case					0.65	K/W
R_{thCH}	thermal resistance case to heatsink					0.1	K/W
P_{tot}	total power dissipation			$T_C = 25^\circ\text{C}$		190	W
I_{FSM}	max. forward surge current	$t = 10$ ms; (50 Hz), sine		$T_{VJ} = 45^\circ\text{C}$		700	A
		$t = 8,3$ ms; (60 Hz), sine		$V_R = 0$ V		755	A
		$t = 10$ ms; (50 Hz), sine		$T_{VJ} = 150^\circ\text{C}$		595	A
		$t = 8,3$ ms; (60 Hz), sine		$V_R = 0$ V		645	A
I^2t	value for fusing	$t = 10$ ms; (50 Hz), sine		$T_{VJ} = 45^\circ\text{C}$		2.45	kA ² s
		$t = 8,3$ ms; (60 Hz), sine		$V_R = 0$ V		2.37	kA ² s
		$t = 10$ ms; (50 Hz), sine		$T_{VJ} = 150^\circ\text{C}$		1.77	kA ² s
		$t = 8,3$ ms; (60 Hz), sine		$V_R = 0$ V		1.73	kA ² s
C_J	junction capacitance	$V_R = 400$ V; $f = 1$ MHz		$T_{VJ} = 25^\circ\text{C}$		27	pF



Brake IGBT				Ratings				
Symbol	Definition	Conditions	min.	typ.	max.	Unit		
V_{CES}	collector emitter voltage				1200	V		
V_{GES}	max. DC gate voltage				±20	V		
V_{GEM}	max. transient gate emitter voltage				±30	V		
I_{C25}	collector current				120	A		
I_{C80}					84	A		
P_{tot}	total power dissipation				390	W		
$V_{CE(sat)}$	collector emitter saturation voltage	$I_C = 75 \text{ A}; V_{GE} = 15 \text{ V}$		1.8	2.1	V		
				2.1		V		
$V_{GE(th)}$	gate emitter threshold voltage	$I_C = 3 \text{ mA}; V_{GE} = V_{CE}$	5.5	6.0	6.5	V		
I_{CES}	collector emitter leakage current	$V_{CE} = V_{CES}; V_{GE} = 0 \text{ V}$			0.2	mA		
				0.6		mA		
I_{GES}	gate emitter leakage current	$V_{GE} = \pm 20 \text{ V}$			500	nA		
$Q_{G(on)}$	total gate charge	$V_{CE} = 600 \text{ V}; V_{GE} = 15 \text{ V}; I_C = 75 \text{ A}$		230		nC		
$t_{d(on)}$	turn-on delay time	inductive load $V_{CE} = 600 \text{ V}; I_C = 75 \text{ A}$ $V_{GE} = \pm 15 \text{ V}; R_G = 10 \Omega$						
t_r	current rise time						70	ns
$t_{d(off)}$	turn-off delay time						40	ns
t_f	current fall time						250	ns
E_{on}	turn-on energy per pulse						100	ns
E_{off}	turn-off energy per pulse						6.8	mJ
E_{off}		8.3	mJ					
RBSOA	reverse bias safe operating area	$V_{GE} = \pm 15 \text{ V}; R_G = 10 \Omega$						
I_{CM}		$V_{CEK} = 1200 \text{ V}$			225	A		
SCSOA	short circuit safe operating area	$V_{CEK} = 1200 \text{ V}$						
t_{SC}	short circuit duration	$V_{CE} = 900 \text{ V}; V_{GE} = \pm 15$			10	µs		
I_{SC}	short circuit current	$R_G = 10 \Omega$; non-repetitive		300		A		
R_{thJC}	thermal resistance junction to case				0.32	K/W		
R_{thCH}	thermal resistance case to heatsink				0.15	K/W		
Brake Diode								
V_{RRM}	max. repetitive reverse voltage				1200	V		
I_{F25}	forward current				48	A		
I_{F80}					32	A		
V_F	forward voltage	$I_F = 30 \text{ A}$			2.75	V		
				1.99		V		
I_R	reverse current	$V_R = V_{RRM}$			0.25	mA		
					1	mA		
Q_{rr}	reverse recovery charge	$V_R = 600 \text{ V}$ $-di_f/dt = 400 \text{ A}/\mu\text{s}$ $I_F = 30 \text{ A}; V_{GE} = 0 \text{ V}$						
I_{RM}	max. reverse recovery current						1.8	µC
t_{rr}	reverse recovery time						23	A
					150	ns		
R_{thJC}	thermal resistance junction to case				0.9	K/W		
R_{thCH}	thermal resistance case to heatsink				0.3	K/W		



Package E2-Pack		Ratings				
Symbol	Definition	Conditions	min.	typ.	max.	Unit
I_{RMS}	RMS current	per terminal			50	A
T_{VJ}	virtual junction temperature		-40		150	°C
T_{op}	operation temperature		-40		125	°C
T_{stg}	storage temperature		-40		125	°C
Weight				176		g
M_D	mounting torque		3		6	Nm
$d_{Spp/App}$	creepage distance on surface / striking distance through air	terminal to terminal	6.0			mm
$d_{Spb/Apb}$		terminal to backside	12.0			mm
V_{ISOL}	isolation voltage	t = 1 second 50/60 Hz, RMS; $I_{ISOL} \leq 1$ mA	3600			V
		t = 1 minute	3000			V

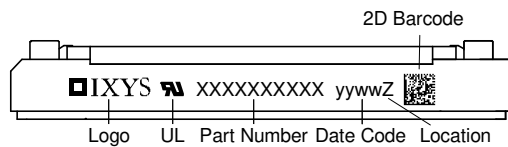

Ordering	Ordering Number	Marking on Product	Delivery Mode	Quantity	Code No.
Standard	VUB116-16NOXT	VUB116-16NOXT	Box	6	510755

Temperature Sensor NTC

Symbol	Definition	Conditions	min.	typ.	max.	Unit
R_{25}	resistance	$T_{VJ} = 25^\circ$	4.75	5	5.25	k Ω
$B_{25/50}$	temperature coefficient			3375		K

Equivalent Circuits for Simulation

* on die level

$T_{VJ} = 150^\circ\text{C}$

		Rectifier	Brake IGBT	Brake Diode	
V_0	threshold voltage	0.8	1.1	1.31	V
R_0	slope resistance *	4.5	17.9	8	m Ω

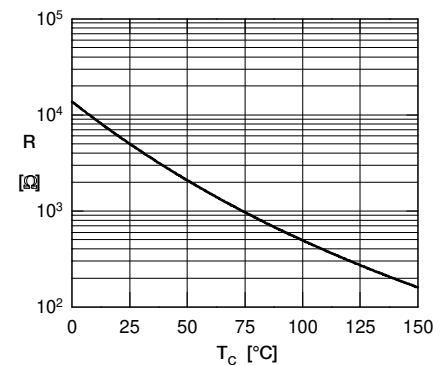



Outlines E2-Pack

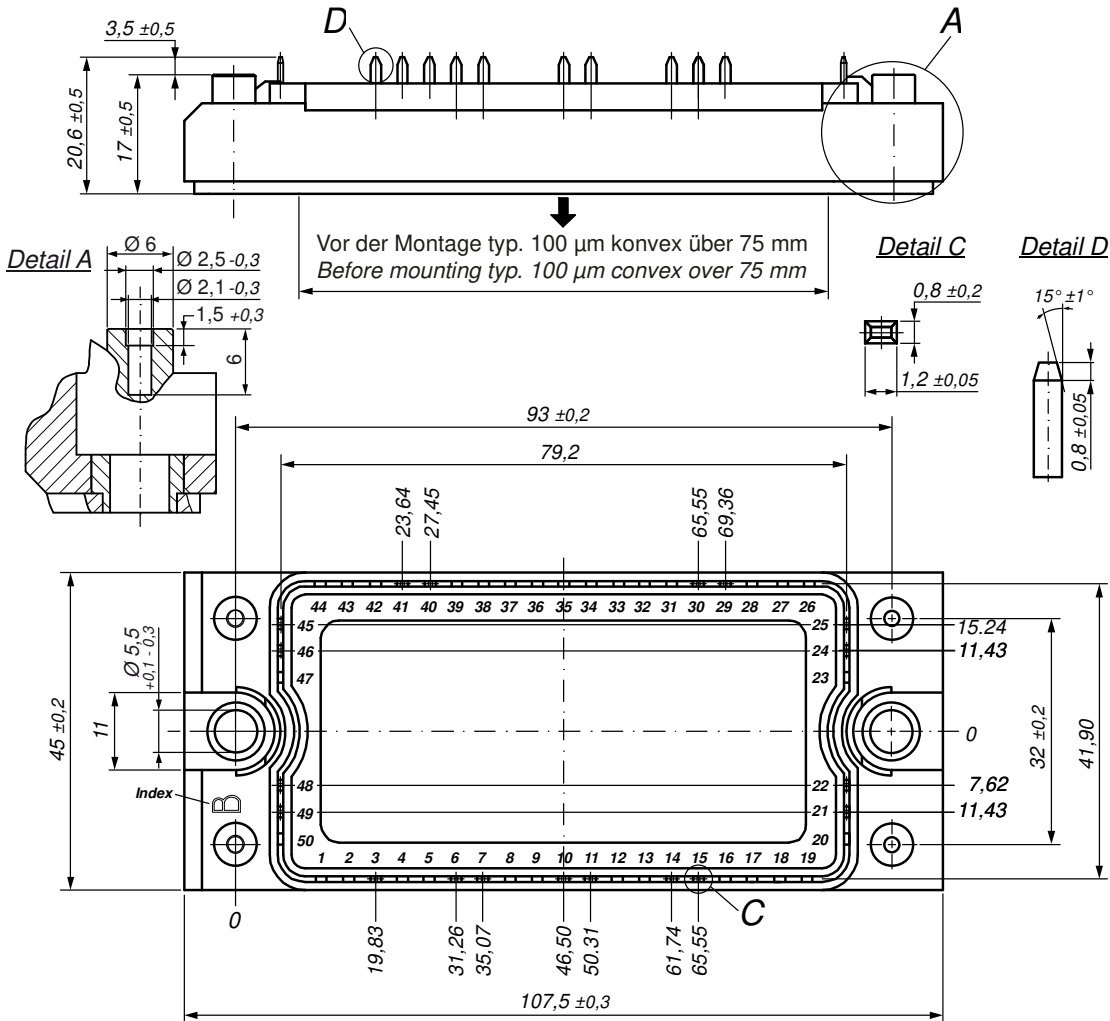

Bemerkung / Note:

- Nichttolerierete Maße nach / Measure without tolerances according DIN ISO 2768-T1-m
- PCB-Lochmuster / PCB hole pattern: **see pin position**
- Toleranz Pin-Position und PCB-Lochmuster / Tolerance of pin position and PCB hole pattern: $\oplus 0.1$
- Montageanleitung / Mounting instruction: www.ixys.com **Application note IXAN0024**

Detail A: PCB-Montage / Mounting on PCB ^L

- Empfohlene, selbstschneidende Schraube / Recommended, self-tapping screw: **EJOT PT®** (Größe / size: **K25**) ^L
- Max. Schraubenlänge / Max. screw length: **PCB-Dicke / thickness + 6 mm** (max. Lochtiefe / hole depth) ^L
- Empfohlenes Drehmoment / Recommended mounting torque: **1.5 Nm**

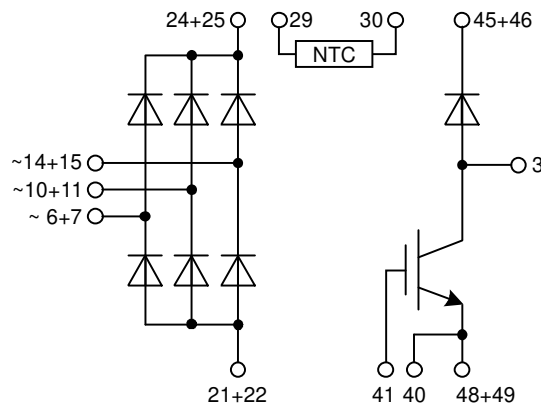

Rectifier

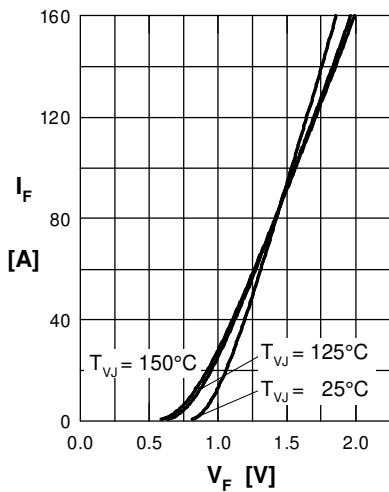

Fig. 1 Forward current versus voltage drop per diode

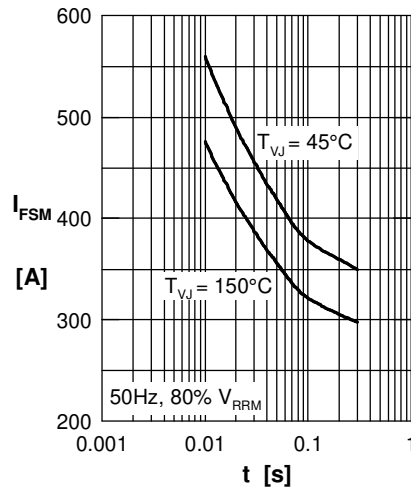

Fig. 2 Surge overload current vs. time per diode

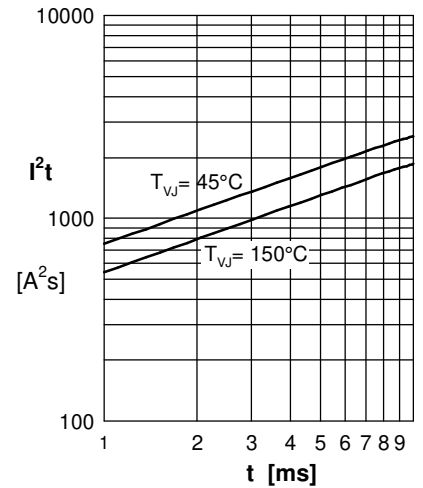

Fig. 3 I^2t versus time per diode

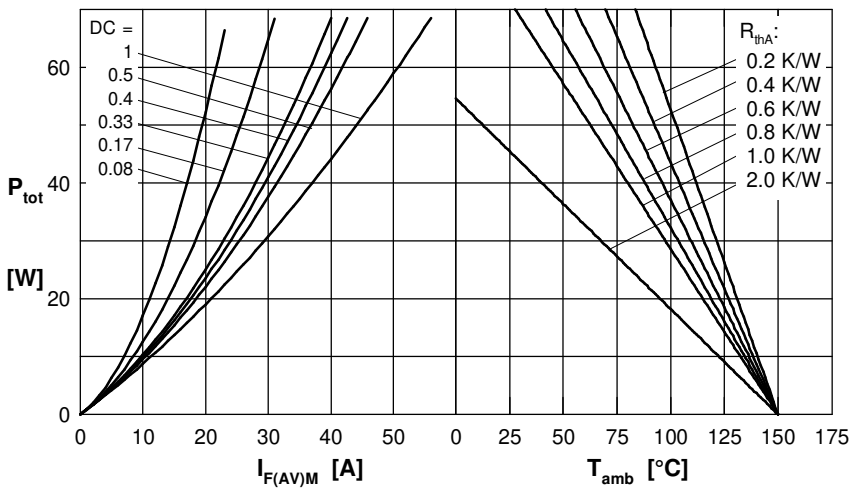

Fig. 4 Power dissipation vs. forward current and ambient temperature per diode

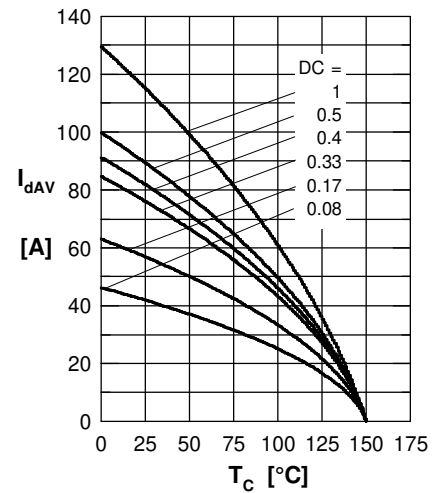

Fig. 5 Max. forward current vs. case temperature per diode

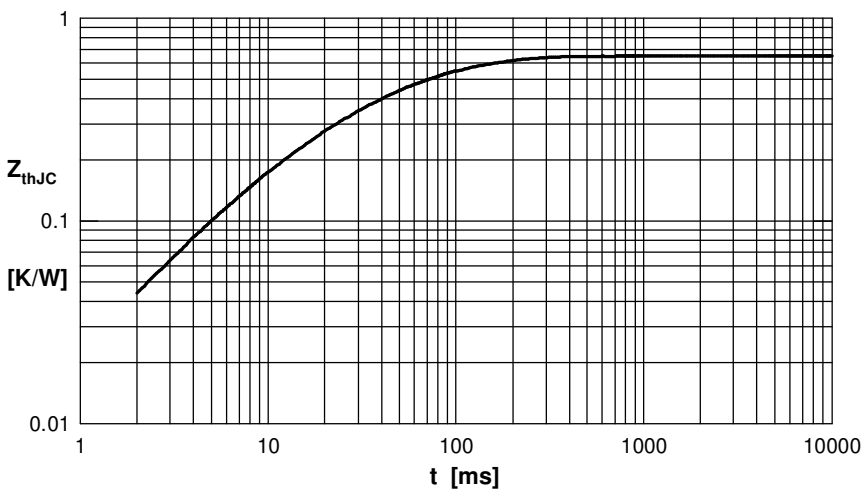

Fig. 6 Transient thermal impedance junction to case vs. time per diode

R_i	t_i
0.085	0.012
0.041	0.007
0.309	0.036
0.215	0.102



Brake IGBT

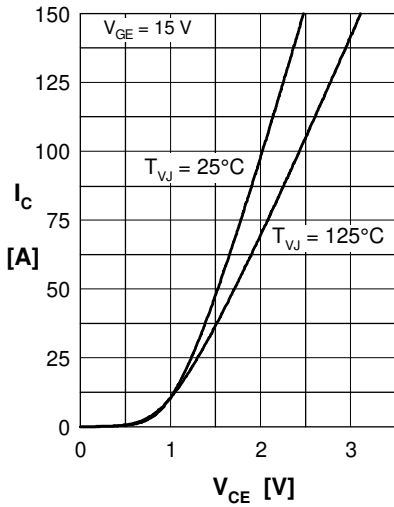

Fig. 1 Typ. output characteristics

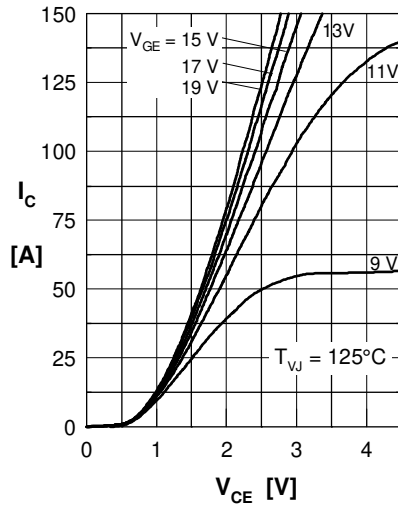

Fig. 2 Typ. output characteristics

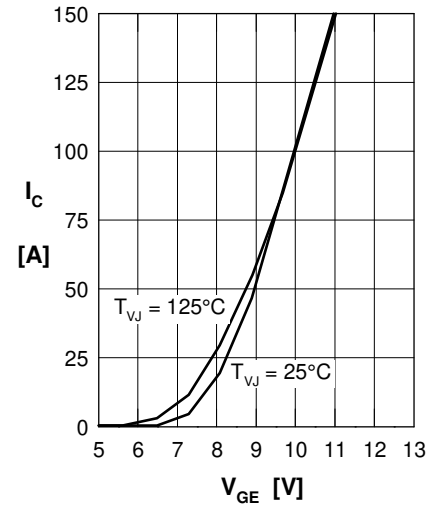

Fig. 3 Typ. transfer characteristics

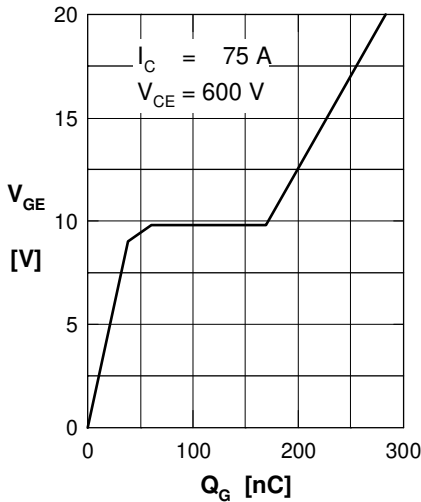

Fig. 4 Typ. turn-on gate charge

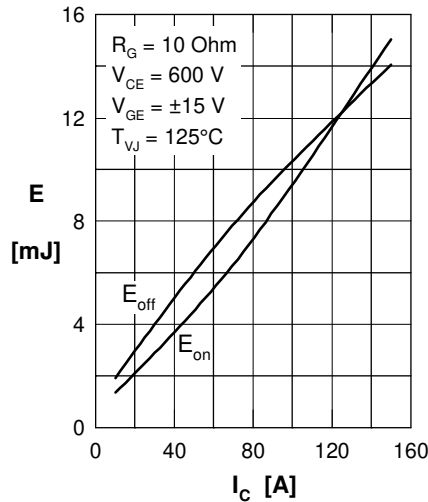

Fig. 5 Typ. switching energy versus collector current

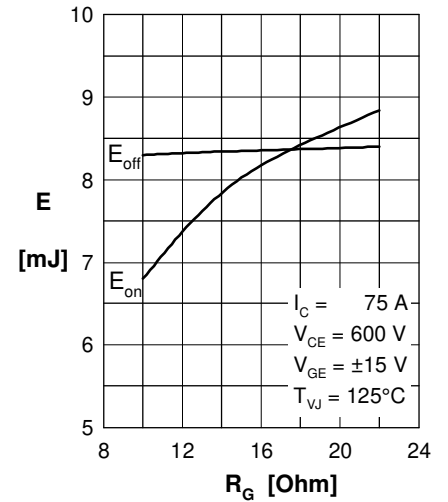

Fig. 6 Typ. switching energy versus gate resistance

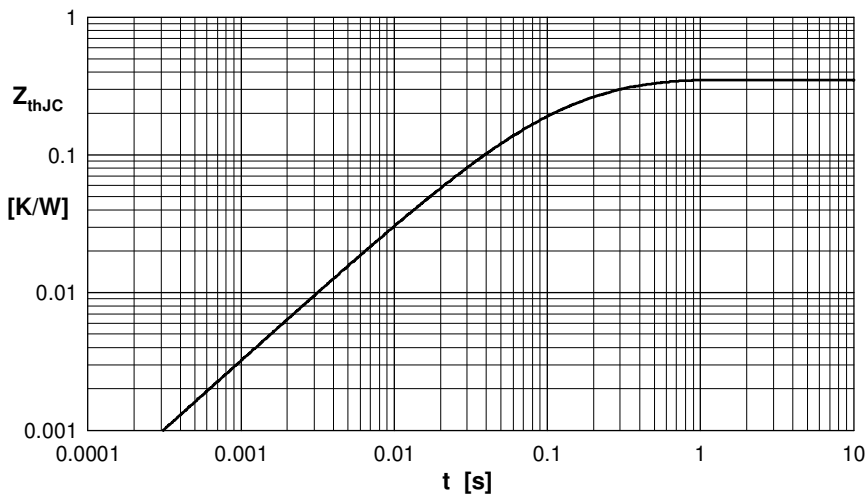

Fig. 7 Typ. transient thermal impedance junction to case

Brake Diode

 Fig. 1 Forward current I_F vs. V_F

 Fig. 2 Typ. reverse recovery charge Q_r versus $-di_F/dt$

 Fig. 3 Typ. peak reverse current I_{RM} versus $-di_F/dt$

 Fig. 4 Dynamic parameters Q_r , I_{RM} versus T_{VJ}

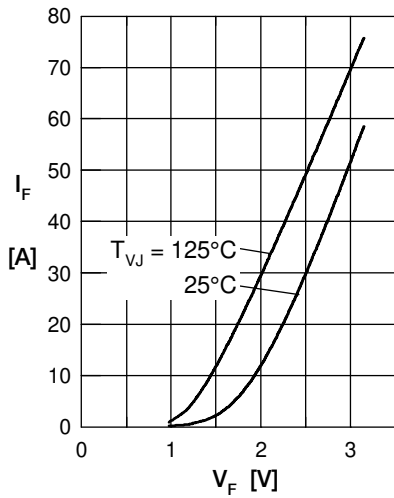
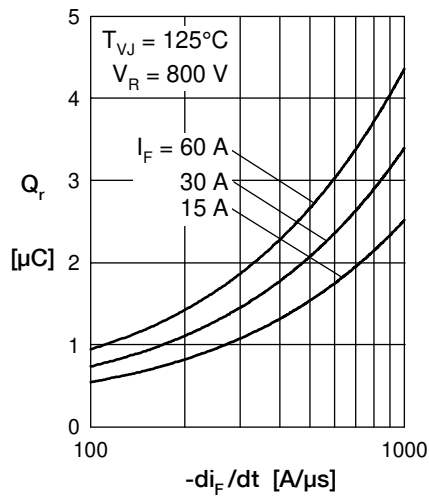
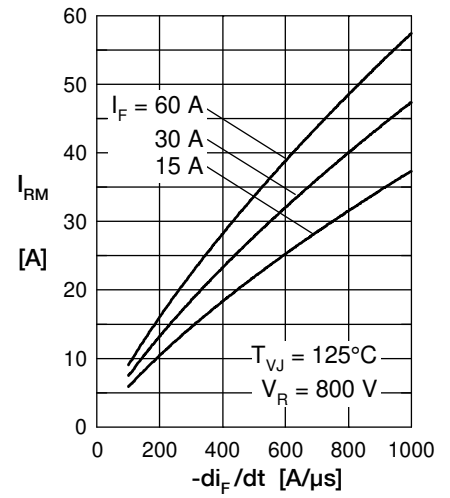
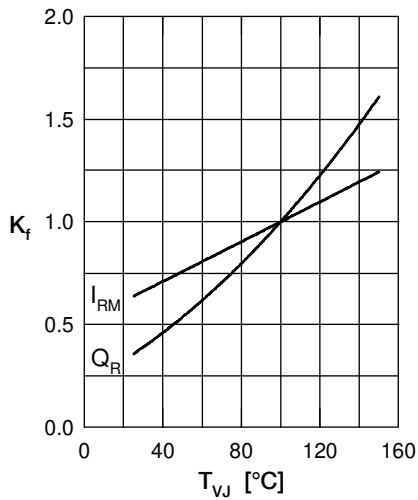
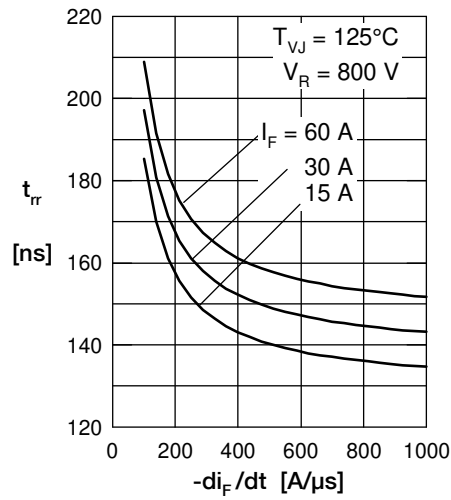
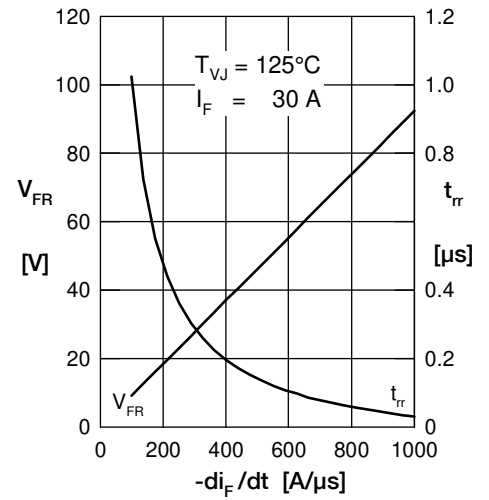
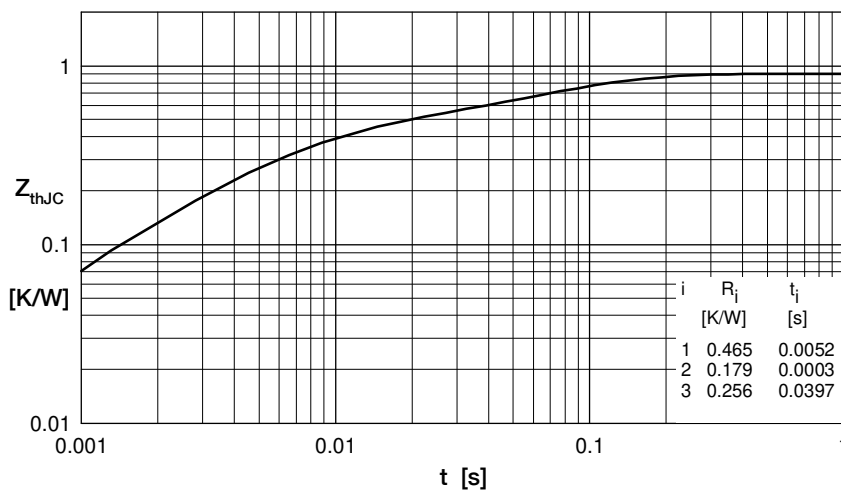
 Fig. 5 Typ. recovery time t_{rr} versus $-di_F/dt$

 Fig. 6 Typ. peak forward voltage V_{FR} and t_{rr} versus di_F/dt

Fig. 7 Transient thermal impedance junction to case