

Specification Status: Released

Maximum Operating Voltage: 60V_{DC}

Fault Ratings at 20°C:

- 250 V_{RMS}, 3A, 10 applications
- 600 V_{RMS}, 1A, 5 applications

Configuration: Two PPTC devices per TSM250 part

Marking:

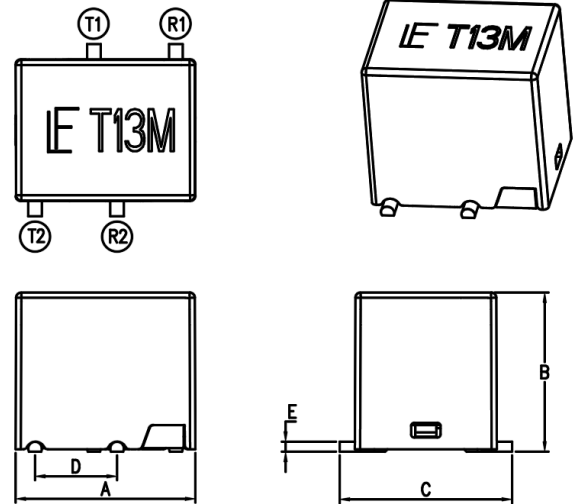
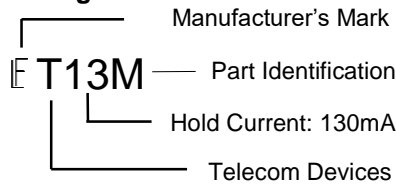

Terminal Description:

- T1 = Tip In T2 = Tip Out
- R1 = Ring In R2 = Ring Out

Table I. Dimensions

	A		B		C		D		E	
	MIN	MAX	MIN	MAX	MIN	MAX	MIN	MAX	MIN	MAX
mm:	8.2	8.9	--	9.0	7.8	8.6	--	3.9	--	0.7
in:	(0.323)	(0.350)	--	(0.354)	(0.307)	(0.339)	--	(0.154)	--	(0.026)

Table II. Performance Ratings @ 20°C (unless otherwise noted)

Part No.	I _{hold} (A)	I _{trip} (A)	RESISTANCE ** @ 20° C (Ω)			TIME TO TRIP @ 1.0 A (Seconds)		OPERATING TEMPERATURE (°C)		TRIPPED STATE POWER DISSIPATION @ 60V _{DC} (W)
			R _{MIN}	R _{MAX}	R _{1 MAX} *	TYP	MAX	MIN	MAX	TYP
TSM250-130F	0.13	0.26	4.0	9.0	15.0	1.0	2.4	-40	85	1.5
TSM250-130F-RA	0.13	0.26	4.0	22.0	30.0	1.0	2.4	-40	85	1.5

* Maximum device resistance: measured 1-hour post reflow or post trip.
** Resistance per PPTC device.

Additional Ratings @ 20°C

- Line Balance: 0.5 Ohm
- Lightning Withstand: 10/700μS, 40 Ω (ITU-T K.20, K.21): 1.5kV, 10 shots, 1 minute interval
- Lightning Withstand: 10/1000μS, 60 Ω: 2.0kV, 30 shots, 3 minutes interval
- Moisture Sensitivity Level (MSL): 1

Recommended Pad Layout (mm)

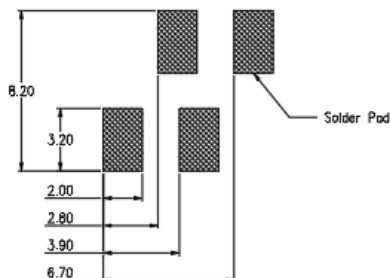

Schematic

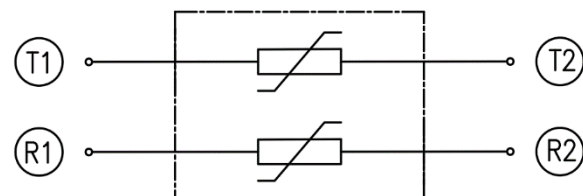

Recommended Reflow Profile

Profile Feature	Pb-Free Assembly
Average ramp up rate (T_SMAX to T_p)	3°C/second max.
Preheat	
* Temperature min. (T _S MIN)	150°C
* Temperature max. (T _S MAX)	200°C
* Time (t _S MIN to t _S MAX)	60-180 seconds
Time maintained above:	
* Temperature (T _L)	217 °C
* Time (t _L)	60-150 seconds
Peak/Classification Temperature (T_p) 260°C	
Time within 5°C of actual peak temperature	
* Time (t _p)	20-40 seconds
Ramp down rate	
	6°C/second max.
Time 25°C to peak temperature	
	8 minutes max.

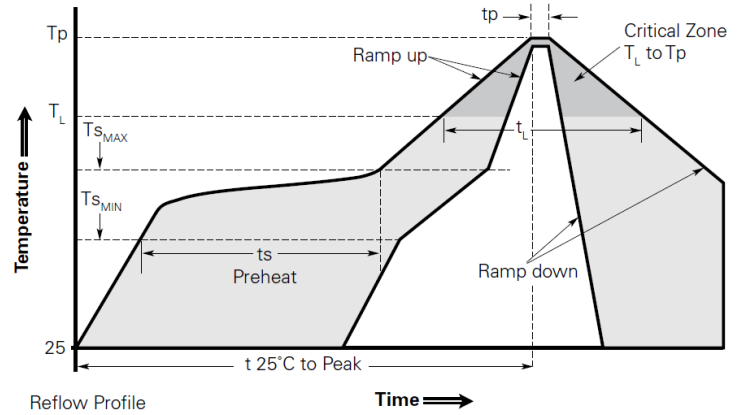

Note: All temperatures refer to topside of the package, measured on the package body surface.

Agency Recognitions: UL (File #E74889)
Reference Documents: PS300
Precedence: This specification takes precedence over documents referenced herein
Effectivity: Reference documents shall be the issue in effect on the date of invitation for bid.

Part Numbering System and Ordering Information

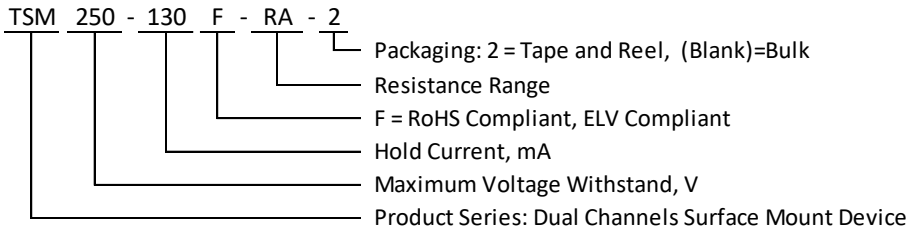

- Packaged with Tape and Reel only, Per EIA481-2
- Standard Package Quantity: 600pcs per reel
- MPQ/MOQ: 3000pcs

TSM250 Tape and Reel Specifications: per EIA 481 standard

Description	EIA Mark	Dimension (mm)	Tolerance (mm)
Carrier tape width	W	24.0	±0.5
Sprocket hole pitch	P ₀	4.0	±0.1
	P ₁	16.0	±0.1
	P ₂	2.0	±0.1
	A ₀	7.05	±0.2
	B ₀	8.85	±0.2
Sprocket hole diameter	B ₁ max.	12.45	
	D	1.5	-0/+1.0
	F	11.5	±0.1
	E ₁	1.75	±0.1
Tape thickness	E2 max.	22.25	
	T max.	0.5	±0.5
Tape thickness with splice	T ₁ max.	0.1	
	K ₀	8.55	±0.2

Reel Dimensions

Reel diameter	A max.	390	
Core diameter	N min.	75	
Space between flanges less device	W ₁	25.4	±0.5
Reel width	W ₂ max.	30.4	

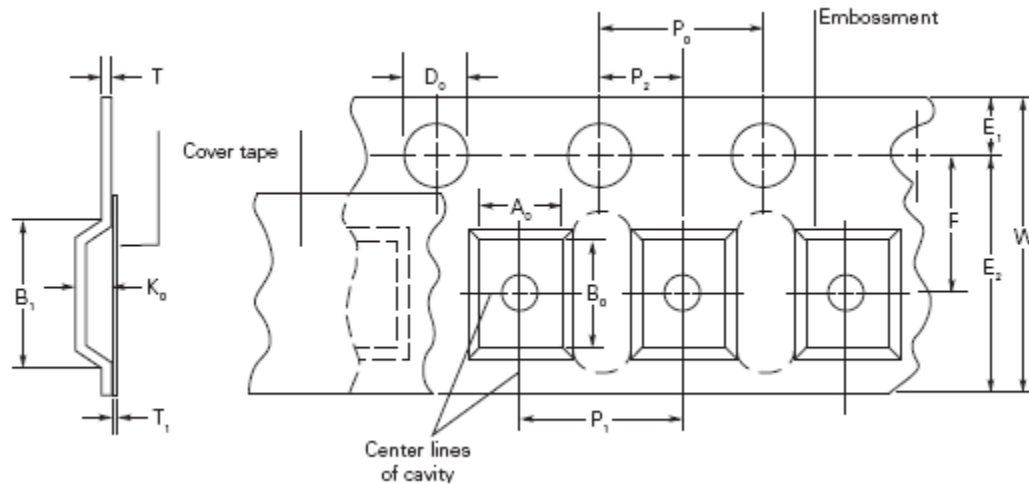

EIA Referenced Reel Dimensions for TSM250 Devices

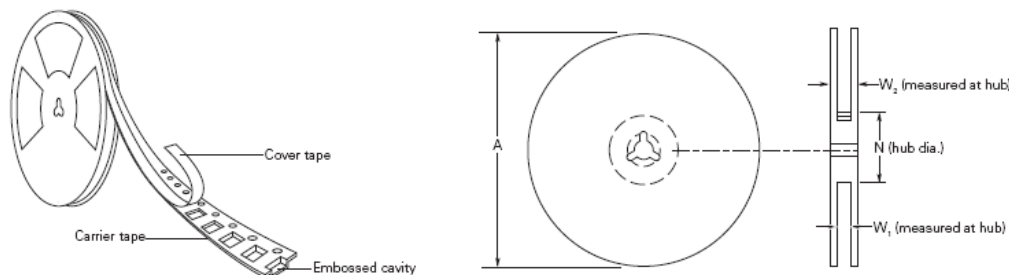

Materials Information

ROHS Compliant

Directive 2011/65/EU
Compliant

ELV Compliant

Directive 2000/53/EC
Compliant

Pb-Free



Information furnished is believed to be accurate and reliable. However, users should independently evaluate the suitability of and test each product selected for their own applications. Littelfuse products are not designed for, and shall not be used for, any purpose (including, without limitation, military, aerospace, medical, lifesaving, life-sustaining or nuclear facility applications, devices intended for surgical implant into the body, or any other application in which the failure or lack of desired operation of the product may result in personal injury, death, or property damage) other than those expressly set forth in applicable Littelfuse product documentation. Warranties granted by Littelfuse shall be deemed void for products used for any purpose not expressly set forth in applicable Littelfuse documentation. Littelfuse shall not be liable for any claims or damages arising out of products used in applications not expressly intended by Littelfuse as set forth in applicable Littelfuse documentation. The sale and use of Littelfuse products is subject to Littelfuse Terms and Conditions of Sale, unless otherwise agreed by Littelfuse.