

**Specification Status: RELEASED**

**Max Electrical Rating at 20°C**

Operating Voltage: 250V<sub>DC</sub>

Interrupt Current: 3A<sub>RMS</sub>



Fault Voltage: 600V<sub>RMS</sub>

Lead Material: Tin plated brass

Configuration: Two PPTC devices per  
 TSM600 part

Case Material: Nylon Resin (UL94 V-0)  
 1000V dielectric rating

**Marking:**

 Manufacturer's Mark  
 TSM600 — Part Identification  
 □ □ □ □ — Lot Identification

**Terminal Description:**

T1 = Tip In    T4 = Tip Out

R2 = Ring In    R3 = Ring Out

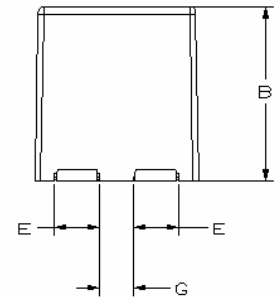
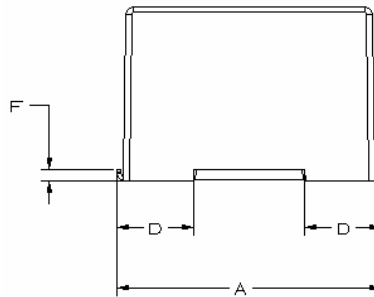
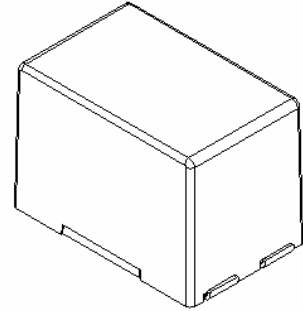
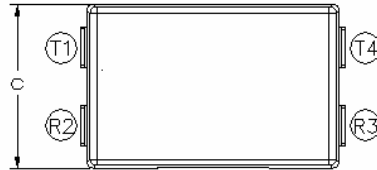

**TABLE I. DIMENSIONS:**

	A		B		C		D		E		F		G	
	MIN	MAX	MIN	MAX	MIN	MAX	MIN	MAX	MIN	MAX	MIN	MAX	MIN	MAX
mm:	17.0	17.6	11.2	11.7	10.4	11.2	4.8	5.2	2.5	2.8	0.6	1.0	2.2	3.1
in:	(0.671)	(0.691)	(0.440)	(0.460)	(0.410)	(0.440)	(0.187)	(0.203)	(0.099)	(0.111)	(0.022)	(0.038)	(0.087)	(0.122)

**TABLE II. PERFORMANCE RATINGS @ 20°C (unless otherwise noted):**

IHOLD (A)		RESISTANCE (Ω)** @ 20° C			TIME TO TRIP @ 3 A (Seconds)		OPERATING TEMPERATURE (°C)		Tripped State Power Dissipation @ 250V (Watts) TYPICAL
20°C	60°C	R MIN	R TYP	R <sub>1</sub> MAX*	TYP	MAX	MIN	MAX	
0.250	0.140	1.0	3.0	5.0	1	6	-40	85	2

\* Maximum device resistance, measured 1-hour post reflow or post trip.

\*\* Resistance per PPTC device.

**Additional Ratings @ 20°C**

Resistance Matched: 0.5 Ohm measured 24 hours after reflow installation

Storage Temperature: -40° to 85° C

Line Balance: 0.5 Ohm, 59 dB @ 4 kHz minimum\*\*\*

Storage Humidity: Per IPC/JEDEC J-STD-020A Level 2a

\*\*\*Tested in accordance with IEEE 455 with a device having a series longitudinal balance value of at least 60dB.

Agency Recognitions: UL, CSA

Reference Documents: PS300

Precedence: This specification takes precedence over documents referenced herein.

Effectivity: Reference documents shall be the issue in effect on the date of invitation for bid.

**MATERIALS INFORMATION**

**ROHS Compliant**

Directive 2002/95/EC  
 Compliant

**ELV Compliant**

Directive 2000/53/EC  
 Compliant

**Pb-Free**



**PolySwitch<sup>®</sup>**  
**PTC Devices**  
**Overcurrent Protection Device**

**PRODUCT: TSM600-250F-RA**

DOCUMENT: SCD26007  
REV LETTER: E  
REV DATE: JULY 26, 2016  
PAGE NO.: 2 OF 2

Information furnished is believed to be accurate and reliable. However, users should independently evaluate the suitability of and test each product selected for their own applications. Littelfuse products are not designed for, and shall not be used for, any purpose (including, without limitation, military, aerospace, medical, lifesaving, life-sustaining or nuclear facility applications, devices intended for surgical implant into the body, or any other application in which the failure or lack of desired operation of the product may result in personal injury, death, or property damage) other than those expressly set forth in applicable Littelfuse product documentation. Warranties granted by Littelfuse shall be deemed void for products used for any purpose not expressly set forth in applicable Littelfuse documentation. Littelfuse shall not be liable for any claims or damages arising out of products used in applications not expressly intended by Littelfuse as set forth in applicable Littelfuse documentation. The sale and use of Littelfuse products is subject to Littelfuse Terms and Conditions of Sale, unless otherwise agreed by Littelfuse.